United States
Department of
Agriculture

**Soil
Conservation
Service**

**Part 623
National
Engineering
Handbook**

Chapter 2

**Irrigation Water
Requirements**

Issued September 1993

The United States Department of Agriculture (USDA) prohibits discrimination in its programs on the basis of race, color, national origin, sex, religion, age, disability, political beliefs, and marital or familial status. (Not all prohibited bases apply to all programs.) Persons with disabilities who require alternative means for communication of program information (braille, large print, audiotape, etc.) should contact the USDA Office of Communications at (202) 720-5881 (voice) or (202) 720-7808 (TDD).

To file a complaint, write the Secretary of Agriculture, U.S. Department of Agriculture, Washington, DC 20250, or call (202) 720-7327 (voice) or (202) 720-1127 (TDD). USDA is an equal employment opportunity employer.

Preface

Irrigation is vital to produce acceptable quality and yield of crops on arid climate croplands. Supplemental irrigation is also vital to produce acceptable quality and yield of crops on croplands in semi-arid and subhumid climates during seasonal droughty periods. The complete management of irrigation water by the user is a necessary activity in our existence as a society. Competition for a limited water supply for other uses by the public require the irrigation water user to provide much closer control than ever before. The importance of irrigated crops is extremely vital to the public's subsistence.

Today's management of irrigation water requires using the best estimate that current technology can provide for the determination of crop water use and field irrigation water requirements. Support for many of the estimated values included in this chapter come from field research and many field evaluations over many years. Field evaluations and ground truthing must always be used to further refine the estimates used for planning irrigation systems. This chapter of the SCS National Engineering Handbook (NEH) provides that current technology. It provides nationwide acceptable procedures to determine crop water needs. The specific procedure or equation used depends on the availability of specific climatic data needed for that process and the desirable intensity level of managing irrigation water.

Chapter 2 describes the processes that affect water use requirements for a crop, field, farm, group of farms, or project level evaluation. The processes include evaluation of crop water use, climatic relationship and data, reference crop evapotranspiration, crop coefficients, leaching requirements for salinity control, temperature control and other auxiliary water requirements, effective precipitation, water table contribution, irrigation efficiencies, on-farm irrigation requirements, and project irrigation requirements. This chapter provides the processes for determining irrigation water requirements for state and local irrigation guides.

Chapter 2 of Part 623 is a new chapter to the family of chapters currently in NEH Section 15, Irrigation. It is written for employees of the Soil Conservation Service who provide technical assistance to the water user with concerns for both water quantity and water quality. Other technical personnel from Federal, State, private, and local agencies will also find the chapter very useful as a basic reference when providing technical assistance relating to irrigation water requirements.

Other chapters in NEH section 15 describe

- Soil-plant relationships and soil water properties that affect movement, retention, and release of water in soil
- Planning farm irrigation systems
- Measurement of irrigation water
- Design of pumping plants
- Design criteria and design procedures for surface, sprinkler, and micro irrigation methods and the variety of systems for each method that can be adaptable to meet local crop, water, and site conditions and irrigation concerns

These chapters will come under the new Part 623, Irrigation, in the National Engineering Handbook series.

Acknowledgments

Chapter 2 is an addition to the National Engineering Handbook, Part 623 (currently known as Section 15, Irrigation). It was prepared by **Dr. Derrel L. Martin**, University of Nebraska at Lincoln, and **Dr. James R. Gilley**, Iowa State University at Ames, under contract to the Soil Conservation Service (SCS). It has been several years in the development and review process. Valuable technical input was also provided by **Otto W. Baumer**, research soil scientist, National Soils Laboratory, SCS, Lincoln, NE. Principal SCS staff who contributed to the development and review of this publication were:

Gylan L. Dickey (retired), **Nelton O. Salch** (retired), **Carroll A. Hackbart** (retired), **Paul K. Koluvek** (retired), **Leland A. Hardy**, **Larry J. Dawson**, and **Elwin A. Ross** (retired), all irrigation engineers from the SCS National Technical Centers (NTC)

Swayne F. Scott (retired) and **Richard Van Klaveren** (head, WNTC Engineering Staff), both former national irrigation engineer, SCS Engineering Division, Washington, DC

William J. Carmack, national water management engineer; **Ronald L. Marlow**, water management engineer; and **Chuck Lander**, agronomist, Washington, DC

Kendall L. Pfeiffer, West NTC; **Floyd Bailey**, Boise, ID; **Carl Pachek**, Phoenix, AZ; and **Jerry Lemunyon**, South NTC, Ft Worth., TX.

Technical adequacy review from outside SCS was provided by **Robert G. Evans**, agricultural engineer, Washington State University at Prosser, for input on the Frost Protection discussion; and **Dale F. Heermann**, Ft. Collins, CO, **James L. Wright**, Kimberly, ID, **Terry A. Howell**, Bushland, TX, **David L. Carter**, Kimberly, ID, and **James D. Rhoades**, Riverside, CA, all research scientists for the USDA, Agricultural Research Service. Editing and publication production assistance were provided by the Technical Publishing Team, SCS National Cartography and GIS Center, Fort Worth, TX. Final detail technical review was provided by **Elwin A. Ross**, irrigation engineer, SCS, Engineering Division, Washington, DC.

Chapter 2

Irrigation Water Requirements

Contents:	623.0200	Water requirements	2-1
	(a)	Introduction	2-1
	(b)	Irrigation requirements	2-1
	623.0201	Crop water use	2-4
	(a)	Introduction	2-4
	(b)	Evapotranspiration processes	2-4
	(c)	Direct measurement of evapotranspiration	2-8
	(d)	Estimating crop evapotranspiration	2-11
	623.0202	Climatic relationships and data	2-13
	(a)	Introduction	2-13
	(b)	Barometric pressure	2-13
	(c)	Air properties	2-14
	(d)	Wind relationships	2-18
	(e)	Estimating net radiation	2-22
	(f)	Estimating solar radiation	2-32
	(g)	Soil heat flux	2-34
	(h)	Weather stations	2-37
	623.0203	Reference crop evapotranspiration	2-41
	(a)	Selection and application of reference crop ET method	2-41
	(b)	Penman-Monteith method	2-43
	(c)	Radiation method	2-52
	(d)	Temperature method	2-56
	(e)	Evaporation pan method	2-62
	(f)	Summary	2-65
	623.0204	Crop coefficients	2-66
	(a)	Fundamental concepts	2-66
	(b)	Determining basal crop coefficients	2-69
	(c)	Water stress factor	2-82
	(d)	Wet soil evaporation	2-85
	(e)	Average crop coefficients	2-88
	(f)	Estimating evaporation during the nongrowing season	2-91
	(g)	Adjusting crop coefficients for real-time predictions	2-92
	(h)	Sensing ground cover	2-97
	(i)	Summary	2-97

623.0205	Leaching requirements for salinity control	2-98
	(a) Significance of salinity	2-98
	(b) Water quality evaluation	2-99
	(c) Crop salt tolerance	2-104
	(d) Leaching for salinity control	2-115
	(e) Salinity management alternatives	2-125
	(f) Reclamation of salt-affected soils	2-129
<hr/>		
623.0206	Auxiliary irrigation water requirements	2-133
	(a) Frost protection	2-133
	(b) Crop and soil cooling	2-137
	(c) Wind erosion control	2-138
	(d) Chemigation	2-139
	(e) Plant disease control	2-140
	(f) Seed germination	2-141
<hr/>		
623.0207	Effective precipitation	2-142
	(a) Introduction	2-142
	(b) Definition of effective precipitation	2-142
	(c) Processes controlling effective precipitation	2-142
	(d) Factors affecting effective precipitation	2-144
	(e) Estimating effective precipitation	2-146
	(f) Carryover soil moisture	2-154
<hr/>		
623.0208	Water table contribution	2-155
	(a) Introduction	2-155
	(b) Steady upward flow	2-158
	(c) Hydraulic properties of soil	2-162
<hr/>		
623.0209	Irrigation efficiencies	2-164
	(a) Introduction	2-164
	(b) Irrigation efficiency (E_i)	2-164
	(c) Uniformity of application	2-167
	(d) Application efficiency (E_a)	2-168
	(e) Irrigation adequacy	2-170
	(f) Conveyance efficiency (E_c)	2-181
<hr/>		
623.0210	Onfarm irrigation requirements	2-187
	(a) Net seasonal irrigation requirements	2-187
	(b) System capacity requirements	2-194
	(c) Net system capacity	2-197
	(d) Irrigation scheduling	2-209

623.0211	Project water requirements	2-216
	(a) Introduction	2-216
	(b) Irrigation project requirements	2-216
	(c) Onfarm delivery schedules	2-223
	(d) Water conservation	2-225
	Appendix A Blaney-Criddle Formula (SCS TR-21)	2-227
	Appendix B Day of Year Calendar	2-259
	References	2-261
	Glossary	2-267
	Symbols	2-275
	Index	2-281

Tables	Table 2-1	Locations of procedures to estimate irrigation water requirements	2-3
	Table 2-2	Albedo for natural surfaces	2-6
	Table 2-3	Average daily value of climatic parameters for an example site near Dodge City, Kansas	2-13
	Table 2-4	Ratio of wind speeds based on measurement heights	2-19
	Table 2-5	Daytime wind speed	2-21
	Table 2-6	Clear sky radiation at sea level for various latitudes and dates	2-26
	Table 2-7	Clear sky radiation correction term for elevation	2-27
	Table 2-8	Values of the a_1 parameter and the atmospheric emittance	2-30
	Table 2-9	Emittance of longwave radiation by a perfect black body	2-31
	Table 2-10	Extraterrestrial radiation	2-33

Table 2-11	Selected air properties for varying temperatures and elevations	2-45
Table 2-12	Aerodynamic resistance for various wind speeds and common configurations of weather stations	2-47
Table 2-13	Adjustment factor b_r for the radiation method	2-54
Table 2-14	Value of parameters used with the radiation method	2-55
Table 2-15	Values of adjustment factor a_t for use in equation 2-50	2-58
Table 2-16	Values of adjustment factor b_n for use in equation 2-51	2-59
Table 2-17	Values of adjustment factor b_u for use in equation 2-51	2-60
Table 2-18	Daily percent of annual daytime hours	2-61
Table 2-19	Pan coefficients for Class A evaporation pans for different ground cover and levels of mean relative humidity and 24-hour wind run	2-63
Table 2-20	Basal crop coefficient parameters for field and vegetable crops for a grass reference crop	2-73
Table 2-21	Basal crop coefficients for alfalfa, clover, grass-legumes, and pastures using a grass reference crop	2-77
Table 2-22	Basal crop coefficients for citrus grown in predominantly dry areas with moderate wind using a grass reference crop	2-78
Table 2-23	Basal crop coefficient for full grown deciduous fruit and nut trees using a grass reference crop	2-79
Table 2-24	Basal crop coefficients for sugarcane using a grass reference crop	2-80
Table 2-25	Basal crop coefficients for grapes with clean cultivation, infrequent irrigation, and dry soil surface most of the season using a grass reference crop	2-80
Table 2-26	Crop coefficients for paddy rice grown in the United States mainland using a grass reference crop	2-81
Table 2-27	Monthly crop coefficients for some perennial crops raised in Northwestern United States	2-81

Table 2-28	Fraction of the soil surface wetted for various types of irrigation	2-85
Table 2-29	Wet soil surface evaporation decay function $f(t)$ and the persistence factor P_f for typical soils	2-86
Table 2-30	Average wet soil evaporation factor	2-88
Table 2-31	Hanway's stages of growth for corn	2-93
Table 2-32	Irrigation water quality guidelines	2-100
Table 2-33	Determinations normally required to evaluate irrigation water quality problems	2-101
Table 2-34	Salt tolerance of selected crops	2-106
Table 2-35	Chloride tolerance limits of some fruit crop cultivars and rootstocks	2-111
Table 2-36	Relative tolerance of selected crops to foliar injury from saline water applied by sprinklers	2-112
Table 2-37	Boron tolerance limits for agricultural crops	2-113
Table 2-38	Citrus and stone fruit rootstocks ranked in order of increasing boron accumulation and transport to leaves	2-114
Table 2-39	Estimates of the electrical conductivity of drainage water for determination of the leaching requirements	2-116
Table 2-40	Sprinkling rate necessary for frost protection	2-135
Table 2-41	Temperatures to start and stop overtree frost protection	2-135
Table 2-42	Factors influencing effective precipitation	2-144
Table 2-43	Average monthly effective precipitation as related to mean monthly precipitation and average monthly crop evapotranspiration	2-148
Table 2-44	Sample calculation of effective precipitation (corn at Raleigh, North Carolina)	2-152
Table 2-45	Sample calculation of effective precipitation (alfalfa at Denver, Colorado)	2-152

Table 2-46	Average ratios applicable to effective precipitation	2-153
Table 2-47	Average values for parameters used in the Brooks and Corey functions	2-163
Table 2-48	Probable application efficiencies of the low-quarter and the low-half for various types of sprinkler systems	2-173
Table 2-49	Example water application efficiencies for furrow irrigation by slope and intake family assuming no reuse of runoff	2-175
Table 2-50	Example water application efficiencies for furrow irrigation by slope and intake family assuming a runoff reuse efficiency of 75 percent	2-176
Table 2-51	Suggested application efficiency for graded border irrigation systems	2-179
Table 2-52	Design application efficiency of level systems as function of the advance ratio AR, where $AR = \text{advance time}/\text{net opportunity time} = T_f/T_n$	2-180
Table 2-53	Conveyance, field, and distribution efficiencies for various types of systems	2-185
Table 2-54	Average 5-day ET_c data for the log-normal frequency analysis data	2-202
Table 2-55	Peak period average daily consumptive use as related to estimated actual monthly use	2-205
Table 2-56	Comparison of the effect of an earliest date and latest date irrigation strategy on system capacity and other performance criteria	2-208
Table 2-57	Example of canal sizing problem for the system shown in figure 2-65	2-224
Table 2A-1	Monthly percentage of daytime hours of the year for northern latitudes	2-228
Table 2A-2	Seasonal consumptive-use crop coefficients for irrigated crops	2-230

	Table 2A-3	A guide for determining planting dates, maturity dates, and lengths of growing seasons as related to mean air temperature	2-231
	Table 2A-4	Values of the climate coefficients for various mean air temperatures	2-232
Figures	Figure 2-1	Diagram of the soil-water balance of a crop root zone	2-2
	Figure 2-2	Flow chart to compute irrigation water requirements	2-3
	Figure 2-3	Energy available for evapotranspiration from crop systems	2-5
	Figure 2-4	Schematic diagram of three types of lysimeters used to measure crop evapotranspiration	2-9
	Figure 2-5	Relationship of vapor pressure and relative humidity to temperature	2-14
	Figure 2-6	Representation of wind speeds within and above a crop canopy	2-18
	Figure 2-7	Variation of albedo during the year for selected latitudes	2-23
	Figure 2-8	Effect of date and elevation on clear sky radiation at 40°N latitude	2-24
	Figure 2-9	Extraterrestrial radiation as a function of time for various latitudes	2-32
	Figure 2-10	Flow chart for computing net radiation	2-35
	Figure 2-11	Changes in ET_0 with distance from the ocean for three locations in California	2-38
	Figure 2-12	Effect of advection on the evaporation rate from an evaporation pan	2-39
	Figure 2-13	Correction factor for evapotranspiration because of advection using data outside or before irrigation development for different sizes of irrigated areas under arid and moderate wind conditions	2-40

Figure 2-14	Variation of the average daily ET_c as affected by the length of the averaging period	2-42
Figure 2-15	Definition sketch for variables used to define the aerodynamic resistance	2-44
Figure 2-16	Flow diagram for computing ET_o using the Penman-Monteith method	2-49
Figure 2-17	Schematic diagram of a Class A evaporation pan	2-62
Figure 2-18	Plot of pan evaporation against Penman-Monteith ET_o to determine a pan coefficient	2-64
Figure 2-19	Generalized basal crop coefficient showing the effects of surface wetness, water stress, and leaf area index during the growing season	2-67
Figure 2-20	Basal crop coefficient for corn grown for grain in a windy and arid environment	2-70
Figure 2-21	Process to compute basal crop coefficients	2-72
Figure 2-22	Functions used to reduce evapotranspiration based on soil-water content	2-83
Figure 2-23	Comparison of basal and average crop coefficients for the average crop coefficient example	2-90
Figure 2-24	Example of the relationship of growth stages of corn to cumulative growing degree days since emergence for western Nebraska	2-93
Figure 2-25	Example of the relationship of crop development to growing degree days for Pioneer 3901 corn grown for 5 years in western Nebraska and 2 years in eastern Nebraska	2-94
Figure 2-26	Variation of growing degree days required from emergence to maturity for six corn varieties of different maturity ratings	2-95
Figure 2-27	Crop growth stages for corn related to the fraction of the growing season based on growing degree days	2-95
Figure 2-28	Example soil-water retention curves for a clay loam soil at various degrees of soil salinity	2-99

Figure 2-29	Relationship among average root zone salinity (saturation extract basis), electrical conductivity of irrigation water, and leaching fraction to use for conditions of conventional irrigation management	2-102
Figure 2-30	Relationship among water uptake-weighted salinity (saturation extract basis), electrical conductivity of irrigation water, and leaching fraction to use for conditions of high-frequency irrigation	2-102
Figure 2-31	Threshold values of Sodium Adsorption Ratio of topsoil and electrical conductivity of infiltrating water associated with the likelihood of substantial losses in permeability	2-103
Figure 2-32	Divisions for classifying crop tolerance to salinity	2-105
Figure 2-33	Prediction of leaching requirement based on crop tolerance and water salinity	2-117
Figure 2-34	Evaporation from land areas for various temperatures and rates of rainfall	2-120
Figure 2-35	Pattern of salt buildup as a function of bed shape and those effects on the germination of seeds placed at different locations on the beds	2-127
Figure 2-36	Depth of water per unit depth of soil required to leach a saline soil by continuous or intermittent ponding, or to leach a soil inherently high in boron	2-130
Figure 2-37	Precipitation pathways	2-143
Figure 2-38	Average monthly effective precipitation as related to mean monthly rainfall and average crop evapotranspiration	2-149
Figure 2-39	Frequency distribution of growing season precipitation	2-151
Figure 2-40	Hydraulic properties for sand and silt loam	2-156
Figure 2-41	Water content and capillary pressure head for two soils that have a steady, upward flow rate of 0.1 inch per day	2-157
Figure 2-42	Water table contribution to irrigation requirements as a function of water table depth	2-159

Figure 2-43	Graphical solution for the water table contribution using the Anat Solution	2-160
Figure 2-44	Diagram of the moisture release curve for a sandy clay loam soil using the method of Brooks and Corey	2-162
Figure 2-45	Procedure to determine the characteristic parameters for the Brooks and Corey functions	2-162
Figure 2-46	Distribution of field application depth indicating adequacy of irrigation	2-170
Figure 2-47	Distribution for two irrigation systems having equal adequacy but different uniformity and application efficiency	2-171
Figure 2-48	Distribution for two irrigation systems having equal uniformity but different adequacy and application efficiency	2-172
Figure 2-49	Application efficiency as related to the coefficient of uniformity and the percent of the area that is deficitly irrigated	2-174
Figure 2-50	Method to estimate seepage losses from irrigation delivery systems	2-186
Figure 2-51	Frequency distribution of mean daily ET_c of ryegrass for each month in a coastal California Valley	2-197
Figure 2-52	Log-normal probability distribution to smooth extreme values for daily ET_c data	2-201
Figure 2-53	Weibull transform for smoothing annual maximum ET_c data to predict the design net capacity required	2-201
Figure 2-54	Ratio of mean peak and mean monthly ET_c for different climates during months of peak water use	2-203
Figure 2-55	Shortage and surplus periods for a system where the capacity is less than the average ET_c during a peak water use period	2-204
Figure 2-56	10-day ET_c , rain and soil water deficit, and the soil water depletion pattern over a growing season as affected by gross system capacity	2-206

Figure 2-57	Design net capacity required for corn grown in eastern Colorado to maintain soil water depletion above a specified depletion for three design probabilities	2-207
Figure 2-58	Checkbook scheduling method	2-210
Figure 2-59	Average daily water use during the season for three crops in North Dakota	2-211
Figure 2-60	Irrigation cycle time, or irrigation interval, and its effect on the soil water depletion at the starting and stopping positions of an irrigation system	2-212
Figure 2-61	Earliest and latest dates to irrigate for a system that applies 1 inch of net irrigation per application and has an allowable depletion of 3 inches, assuming the irrigation interval is 3 days	2-213
Figure 2-62	Example of regional ET_c data for irrigation scheduling	2-215
Figure 2-63	Processes involved in sizing irrigation projects	2-221
Figure 2-64	System capacity curve for a conveyance system	2-222
Figure 2-65	Delivery system layout for a farm served by a large lateral canal	2-223
Figure 2-66	An evaluation form for water conservation inventories of irrigation systems	2-226
Figure 2A-1	Crop growth stage coefficient curve for alfalfa	2-235
Figure 2A-2	Crop growth stage coefficient curve for avocados	2-236
Figure 2A-3	Crop growth stage coefficient curve for dry beans	2-237
Figure 2A-4	Crop growth stage coefficient curve for snap beans	2-238
Figure 2A-5	Crop growth stage coefficient curve for sugar beets	2-239
Figure 2A-6	Crop growth stage coefficient curve for citrus	2-240
Figure 2A-7	Crop growth stage coefficient curve for corn (grain)	2-241
Figure 2A-8	Crop growth stage coefficient curve for corn (silage)	2-242
Figure 2A-9	Crop growth stage coefficient curve for sweet corn	2-243
Figure 2A-10	Crop growth stage coefficient curve for cotton	2-244

Figure 2A-11	Crop growth stage coefficient curve for spring grain	2-245
Figure 2A-12	Crop growth stage coefficient curve for grapes	2-246
Figure 2A-13	Crop growth stage coefficient curve for melons and cantaloupes	2-247
Figure 2A-14	Crop growth stage coefficient curve for deciduous orchards	2-248
Figure 2A-15	Crop growth stage coefficient curve for pasture grasses	2-249
Figure 2A-16	Crop growth stage coefficient curve for peas	2-250
Figure 2A-17	Crop growth stage coefficient curve for Irish potatoes	2-251
Figure 2A-18	Crop growth stage coefficient curve for grain sorghum	2-252
Figure 2A-19	Crop growth stage coefficient curve for soybeans	2-253
Figure 2A-20	Crop growth stage coefficient curve for tomatoes	2-254
Figure 2A-21	Crop growth stage coefficient curve for small vegetables	2-255
Figure 2A-22	Crop growth stage coefficient curve for walnuts	2-256
Figure 2A-23	Crop growth stage coefficient curve for winter wheat	2-257

Examples	Example 2-1	Dew point	2-15
	Example 2-2	Vapor pressure deficit	2-16
	Example 2-3	Wind speed computations	2-20
	Example 2-4	Clear sky radiation	2-25
	Example 2-5	Outgoing longwave radiation	2-28
	Example 2-6	Outgoing longwave radiation for a clear sky	2-29
	Example 2-7	Net outgoing longwave radiation	2-29
	Example 2-8	R_s estimate	2-34

Example 2-9	Daily soil heat flux	2-36
Example 2-10	Monthly soil heat flux	2-37
Example 2-11	Penman-Monteith method	2-48
Example 2-12	ET _o —Radiation method	2-53
Example 2-13	FAO Blaney-Criddle	2-57
Example 2-14	Local calibration of a pan coefficient	2-65
Example 2-15	Basal crop coefficient	2-71
Example 2-16	Water stress factor	2-84
Example 2-17	Wet soil surface evaporation	2-87
Example 2-18	Average crop coefficient	2-89
Example 2-19	Nongrowing season crop coefficient	2-91
Example 2-20	Growth adjustment	2-96
Example 2-21	Leaching requirement	2-118
Example 2-22	Leaching requirement calculations	2-120
Example 2-23	Using table 2-46 to estimate the growing season effective precipitation	2-153
Example 2-24	Anat's Solution	2-161
Example 2-25	Determining the gross application for graded furrow irrigation	2-177
Example 2-26	Use of the application efficiency table for graded border irrigation	2-178
Example 2-27	Seepage loss	2-184
Example 2-28	Seasonal irrigation requirement when leaching is unnecessary	2-187
Example 2-29	Seasonal irrigation requirement when leaching is needed	2-190
Example 2-30	Seasonal irrigation requirement for an arid area	2-193
Example 2-31	Seasonal irrigation requirement for a surface system	2-194

Example 2-32	Farm capacity	2-196
Example 2-33	Peak evapotranspiration frequency analysis	2-199
Example 2-34	Weibull distribution	2-200
Example 2-35	Peak evapotranspiration	2-202
Example 2-36	System capacity for corn in eastern Colorado	2-207
Example 2-37	Irrigation scheduling	2-214
Example 2-38	Continuous delivery system	2-218
Example 2-39	Rotational delivery system	2-219

**Sample
Calculations**

Sample calculation 2A-1	Estimate of average daily, monthly, and seasonal consumptive-use by corn (harvested for grain) at Raleigh, North Carolina, latitude 35°47' N	2-233
Sample calculation 2A-2	Estimate of average daily, monthly, and seasonal consumptive use by alfalfa at Denver, Colorado	2-234

623.0200 Water requirements

(a) Introduction

Irrigated agriculture is facing new challenges that require refined management and innovative design. Formerly, emphasis centered on project design; however, current issues involve limited water supplies with several competing users, the threat of water quality degradation through excess irrigation, and narrow economic margins. Meeting these challenges requires improved prediction of irrigation water requirements.

Irrigation water requirements can be defined as the quantity, or depth, of irrigation water in addition to precipitation required to produce the desired crop yield and quality and to maintain an acceptable salt balance in the root zone. This quantity of water must be determined for such uses as irrigation scheduling for a specific field and seasonal water needs for planning, management, and development of irrigation projects.

The amount and timing of precipitation strongly influence irrigation water requirements. In arid areas, annual precipitation is generally less than 10 inches and irrigation is necessary to successfully grow farm crops. In semiarid areas (those typically receiving between 15 to 20 inches of annual precipitation), crops can be grown without irrigation, but are subject to droughts that reduce crop yields and can result in crop failure in extreme drought conditions.

Subhumid areas, which receive from 20 to 30 inches of annual precipitation, are typically characterized by short, dry periods. Depending on the available water storage capacity of soils and the crop rooting depth, irrigation may be needed for short periods during the growing season in these areas.

In humid areas, those receiving more than 30 inches of annual precipitation, the amount of precipitation normally exceeds evapotranspiration throughout most of the year. However, drought periods sometimes occur, which reduce yield and impair quality, especially for crops grown on shallow, sandy soils or that

have a shallow root system. Irrigation is not needed to produce a crop in most years, but may be needed to protect against an occasional crop failure and to maintain product quality.

A unified procedure is needed to predict irrigation water requirements for the diverse soils, climates, and crops that are of interest to the Soil Conservation Service and its clients. Irrigation water requirement information is needed in all aspects of irrigation design and management. Procedures to estimate the irrigation water requirement for this broad range of needs are presented in this chapter.

(b) Irrigation requirements

The primary objective of irrigation is to provide plants with sufficient water to obtain optimum yields and a high quality harvested product. The required timing and amount of applied water is determined by the prevailing climatic conditions, the crop and its stage of growth, soil properties (such as water holding capacity), and the extent of root development. Water within the crop root zone is the source of water for crop evapotranspiration. Thus, it is important to consider the field water balance to determine the irrigation water requirements.

Plant roots require moisture and oxygen to live. Where either is out of balance, root functions are slowed and crop growth reduced.

All crops have critical growth periods when even small moisture stress can significantly impact crop yields and quality. Critical water needs periods vary crop by crop. Soil moisture during the critical water periods should be maintained at sufficient levels to ensure the plant does not stress from lack of water.

(1) Soil-water balance

Producing optimal yield requires that the soil-water content be maintained between an upper limit at which leaching becomes excessive and a lower point at which crops are stressed. For irrigation management, the acceptable soil-water range is generally defined using the available soil-water concept which is the difference between the field capacity and the permanent wilting point. *Field capacity* is defined as the water content at which drainage becomes negligible on a free draining soil. The minimum soil-water

content is defined when plants permanently wilt and is called the *permanent wilting point*. The soil water stored between field capacity and the permanent wilting point is called the total available water or *available water capacity* (AWC).

An allowable depletion is generally defined for irrigation management. The allowable depletion is a management decision based on the grower's production objectives and is referred to as the Management Allowed Depletion (MAD). This is the driest soil-water content that is allowed before irrigation so that undesirable crop water stress does not occur. To prevent reduced yield or quality, the crop should be irrigated before a given percentage of the available water in the root zone has been used by the crop. Historically, an allowable depletion of between 30 and 60 percent of the AWC has been used for management purposes. The soil can be irrigated before allowable depletion is reached if the amount of water applied does not cause the soil water in the crop root zone to exceed field capacity.

Maintaining the soil water within the acceptable range requires information about the addition and extraction of water to the crop root zone. The major processes affecting the soil-water balance are illustrated in figure 2-1. For design and management purposes, the field water balance can be written mathematically as:

$$F_g = ET_c + D_p + RO - P - GW + SD_L - \Delta SW \quad [2-1]$$

where:

- F_g = gross irrigation required during the period
- ET_c = amount of crop evapotranspiration during the period
- D_p = deep percolation from the crop root zone during the period
- RO = surface runoff that leaves the field during the period
- P = total precipitation during the period
- GW = ground water contribution to the crop root zone during the period
- SD_L = spray and drift losses from irrigation water in air and evaporation off of plant canopies
- ΔSW = change in soil water in the crop root zone during the period

The unit on each of the terms of the water balance is volume per unit area or units of length or depth of water.

The time over which the water balance is computed is extremely important. A monthly time step may be satisfactory for preliminary planning purposes, but most irrigation scheduling procedures require a daily time step to predict irrigation dates. In any case, the sum of the irrigation depths over the growing season forms the basis for determining the annual irrigation water requirements.

Equation 2-1 is the basis for the determination of the Water Balance/Budget development process. It can also be used for a long-term (yearly, multiyear) evaluation of "what water goes where" for determining contributions to downstream surface water and ground water. It can be applied to a field, farm, or group of farms.

A flow chart showing the calculation of irrigation water requirements in equation 2-1 is given in figure 2-2. Detailed discussion of each of the components is provided in other parts of this chapter. Locations of the procedures within chapter 2 are given in table 2-1.

Figure 2-1 Diagram of the soil-water balance of a crop root zone

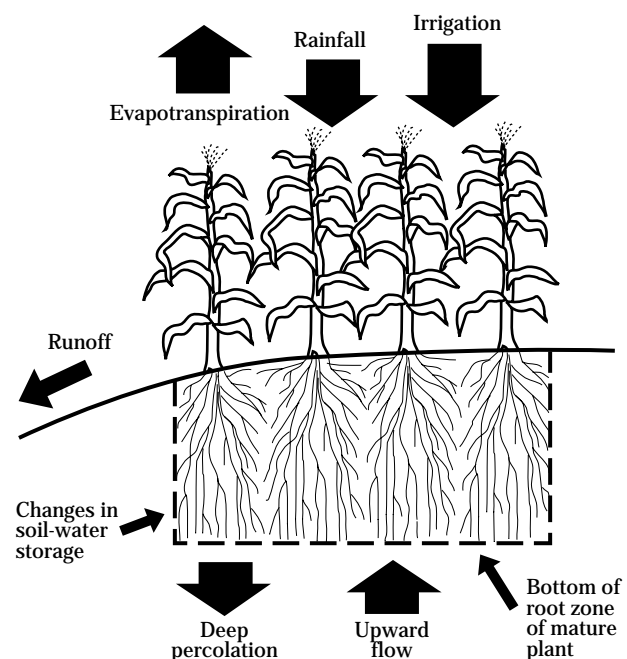

Some items in the process shown in figure 2-2 should be determined or supported by making local field evaluations and onsite monitoring. The values displayed in this chapter are best estimates and generally show a range. They must be supported with good field judgment and local ground truthing. Most surface irrigation systems are operated and managed in a manner that allows runoff or deep percolation, or both, to occur, and all losses are nearly economically or physically impossible to eliminate. With most sprinkler systems, losses because of evaporation and wind drift are present and difficult to control. Local physical site conditions will vary; however, the estimated values included in this chapter are based on well managed irrigation systems and average site conditions.

Table 2-1 Locations of procedures to estimate irrigation water requirements

Process	Location of procedure
Crop water use	623.0201
Climatic processes	623.0202
Reference crop evapotranspiration	623.0203
Crop coefficients	623.0204
Leaching requirements	623.0205
Auxiliary water needs	623.0206
Effective precipitation	623.0207
Water table contributions	623.0208
Irrigation efficiency	623.0209
Onfarm irrigation requirements	623.0210
Project requirements	623.0211

Figure 2-2 Flow chart to compute irrigation water requirements

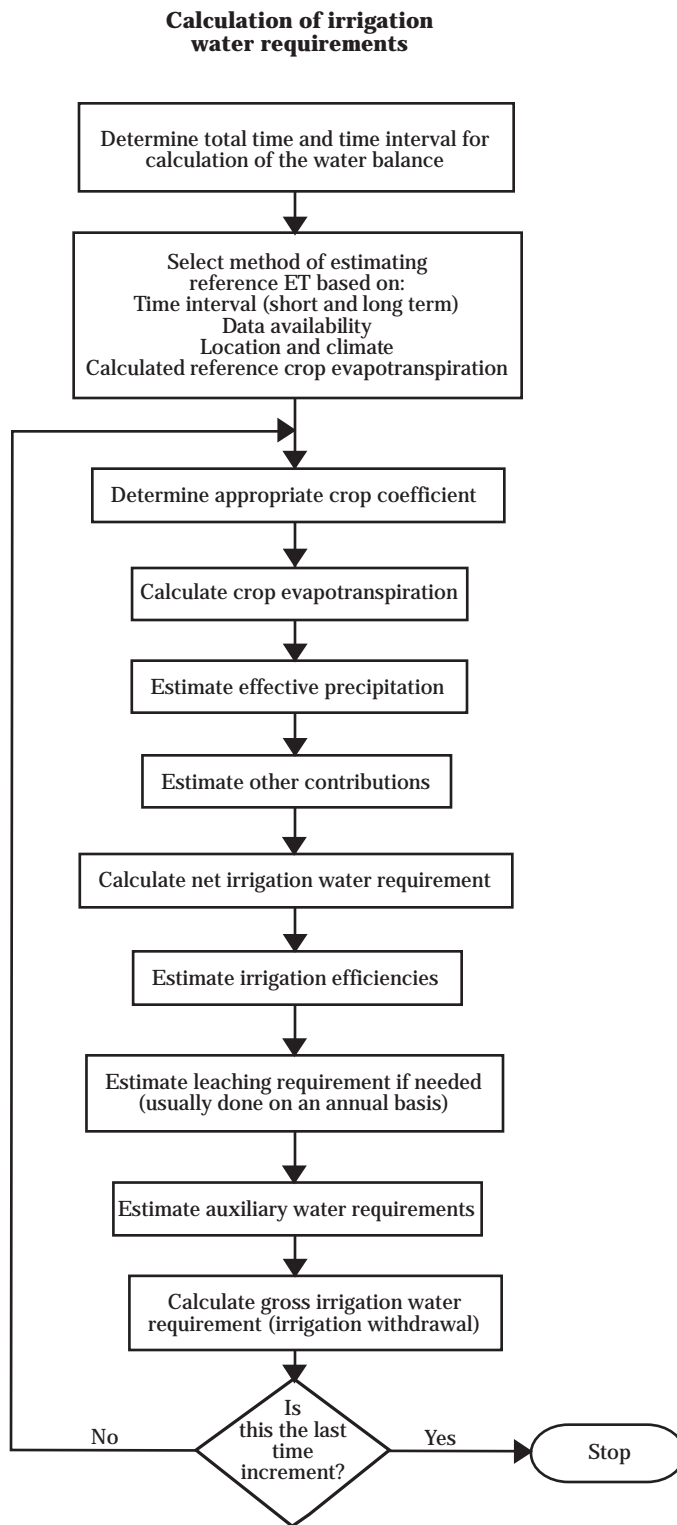

623.0201 Crop water use

(a) Introduction

The determination of irrigation water requirements and irrigation schedules requires an accurate estimate of the crop water use rate. Daily and weekly crop water use estimates are needed to schedule irrigations, while longer term estimates are needed to specify the irrigation, storage, and conveyance system capacities. Annual water use is often required to size irrigation reservoirs and establish water rights. Therefore, a procedure to predict both the short- and long-term rates of water use by a multitude of crops in varying climates is needed.

This section provides an overview of the processes affecting the rate of crop water use and methods to measure crop water use. It explains the general procedures used to estimate crop water use from climatic data. Procedures to actually compute crop water use rates are then presented in sections 623.0202, 623.0203, and 623.0204.

(b) Evapotranspiration processes

Plants need water for growth and cooling especially on sunny days that have hot, dry winds. Plants extract water from the soil and transport the water to the plant leaves. Small apertures (stomata) located on the upper and lower surfaces of the leaves allow for the intake of carbon dioxide required for photosynthesis and plant growth. Water vapor is lost from the plant leaves by evaporation in the stomatal cavity and the flow of the water vapor through the stomata and into the atmosphere. This process is called transpiration. A considerable amount of energy is required to evaporate the water in the stomatal cavity. If the water did not evaporate, the energy would be used to heat the plant. Without transpiration, plants could reach lethal temperatures.

Plant leaves can be coated with liquid phase of water following rain or sprinkler irrigation or because of dew formation. Water on the plant leaves will rapidly evaporate following the deposition period. However, evaporation from the plant canopy serves the same cooling effect as transpiration.

Water in the soil also evaporates as solar energy or hot, dry winds reach the soil surface. Initially, evaporation from a wet soil surface progresses at a maximum energy limiting rate. As the soil surface dries because of evaporation, water below the soil surface moves upward by capillary action. As soil dries the rate of water flow in the soil decreases. Thus, as evaporation continues, there is more resistance to water flow and eventually the rate of soil-water flow limits evaporation. Where the rate of soil-water flow limits evaporation, excess energy is at the soil surface. The energy not used to evaporate water then heats the soil and air just above the soil surface. If this process continues, the soil and air become quite hot, as in desert climates.

As the soil dries, freewater in the pore space is used first. The remaining soil water is held to the soil particles by various chemical and physical bonds and is more difficult to extract. As soil water decreases, the water with the strongest bond is more difficult for roots to absorb. Water in the soil held at more than the permanent wilting point tension (15 atmos) is held tightly to the soil particles and is not readily available to the plant.

Evaporation of water from the soil and plant surfaces and transpiration from the stomatal cavities of plants account for more than 98 percent of the crop water use of most plant species. Evaporation and transpiration are difficult to measure because the rate of water vapor movement from several surfaces into a dynamic environment varies with time. The process of making measurements can alter the local climate around the plant and change the actual rate of evaporation or transpiration. Therefore, for most irrigation applications, evaporation and transpiration fluxes are combined and are called evapotranspiration.

Because evapotranspiration is the loss of water vapor from both plant and soil surfaces, many methods of estimating crop water use depend upon determining the rate that liquid water is converted to water vapor. This process, called evaporation or vaporization, requires energy. For example, the solar energy absorbed by a plant on a bright, sunny summer day would be adequate to evaporate enough water to cover the soil surface to a depth of about 0.4 inch. For an area of 1 acre, the amount of water lost on such a day would be about 11,000 gallons. Thus, the evapotranspiration process requires a large amount of water, which requires a great deal of energy.

The energy available for evapotranspiration from a crop system can come from several sources (fig. 2-3). The largest energy source is from solar radiation. The extraterrestrial radiation from the sun varies during the season, but is very constant from year to year, primarily depending on latitude. However, a large amount of the extraterrestrial radiation is absorbed or reflected in the atmosphere. The energy that ultimately reaches the crop canopy, generally called solar radiation, is available in the shortwave length band (i.e., from 0.1 to 5 microns) of the solar radiation spectrum.

Crop and soil surfaces reflect some of the incoming solar radiation. The portion of the solar radiation absorbed varies depending primarily on the color and other properties of the absorbing surface. The solar radiation that is reflected back to the atmosphere is generally described using a term called the albedo. The albedo (α) is the ratio of the reflected radiation (R_r) to incoming radiation (R_s):

$$\alpha = R_r/R_s$$

Figure 2-3 Energy available for evapotranspiration from crop systems

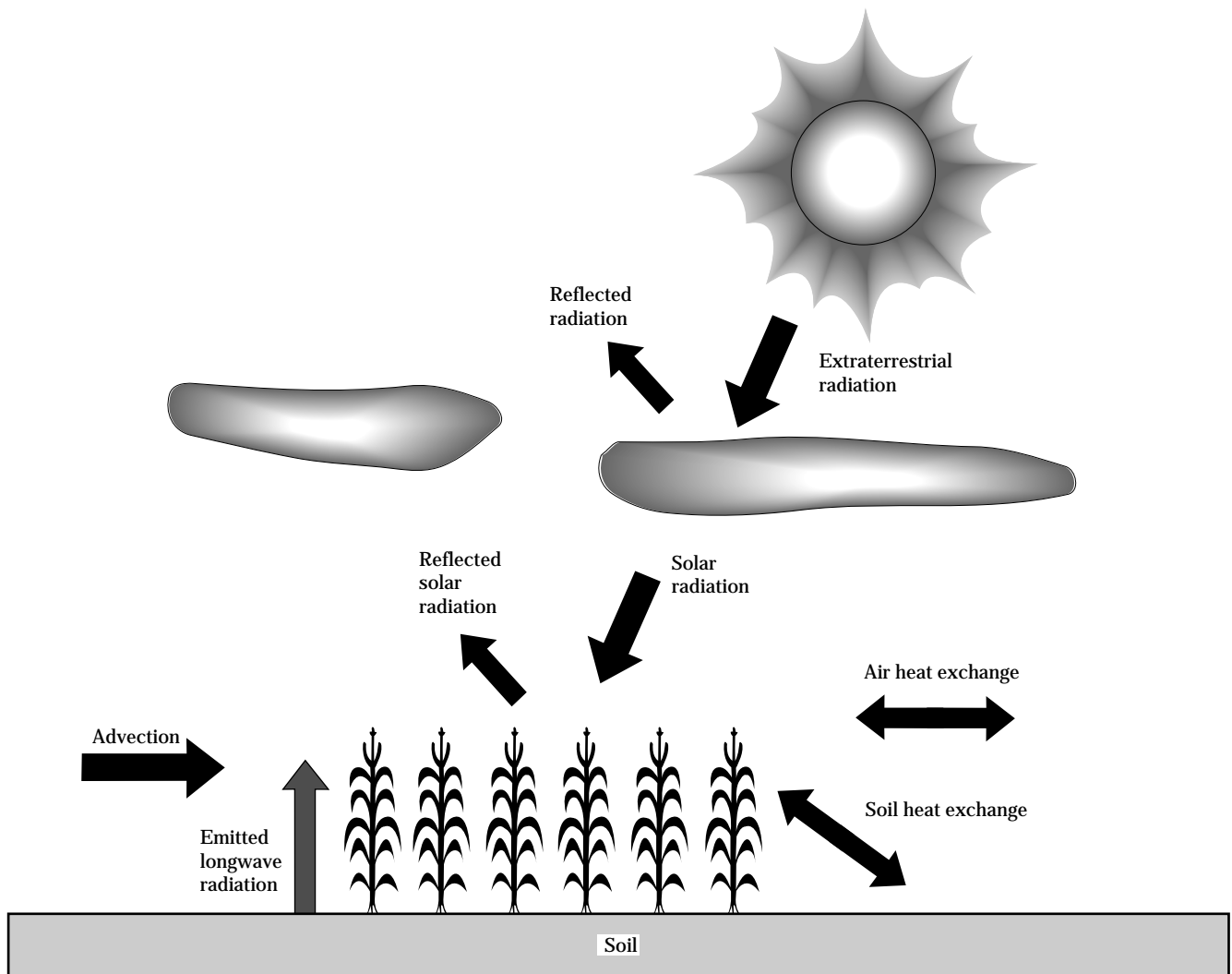

Representative albedo values for various crops and soils are summarized in table 2-2. The albedo values from this table indicate that about 20 to 25 percent of the incoming solar energy is reflected by plant and soil surfaces. A commonly used albedo value for practical irrigation management is 23 percent. In this case the remaining 77 percent of the solar radiation is absorbed and is primarily used for evapotranspiration.

The second component of the radiation balance is called longwave radiation, which occurs in the wavelength band from 3 to 70 microns. This is energy transfer because of the temperature difference between two objects. For field crops, the two bodies exchanging energy are difficult to define. In general, the two surfaces are the crop-soil surface and the outer atmosphere. The rate of longwave energy emission is proportional to the absolute temperature of the surface raised to the fourth power. Because the outer atmosphere is cold relative to the Earth's surface, the longwave energy is lost from the plant-soil system.

The amount of radiant energy available for evapotranspiration, called net radiation (R_n), is the sum of the absorbed solar radiation minus the emitted longwave radiation. In many locations, net radiation is the dominant energy term and may be sufficient to estimate evapotranspiration, especially for long time periods. Procedures to compute the amount of net radiation will be presented in a later section.

Advection is the transfer of heat by horizontal movement of air. The amount of heat energy transferred

depends on the wind speed and the humidity of the air, which is an index of the amount of water vapor in the air. The humidity, however, depends on the temperature and barometric pressure. The concept of vapor pressure is used to describe the evaporative capacity of the air.

Dalton's law of partial pressure states that the pressure exerted by a mixture of ideal gases in a given volume is equal to the sum of the pressures exerted by each individual gas if it alone occupied the given volume. Because moist air behaves as a nearly ideal gas and obeys Dalton's law, the part of the barometric pressure caused by water vapor in the air can be considered independent from the other gases in the air. The partial pressure exerted by water vapor, called the vapor pressure of the air (e), is usually expressed in units of millibars (mb). For reference purposes, a pressure of 1 pound per square inch is equivalent to about 69 millibars.

At an air-water interface, water molecules continually flow from the water into the air and from the air back into the liquid surface. If the air is dry, more molecules leave the liquid than enter, resulting in evaporation. If air in a sealed container is left in contact with water long enough, the rate of molecules leaving and entering the liquid surface will reach equilibrium. Where equilibrium exists with pure water, the air is saturated with water vapor. The partial pressure exerted by the vapor at this equilibrium condition is defined as the saturated vapor pressure of the air (e^0). The saturated vapor pressure is strongly dependent on temperature. The ratio of the actual vapor pressure to the saturated vapor pressure (e / e^0) is the relative humidity of the air.

Air in the soil matrix and within the stomatal cavities is often saturated and thus has a high vapor pressure. If air surrounding the plant and soil is at the same temperature as the crop and soil, but much drier, it will have a lower vapor pressure. Water vapor moves from locations of high vapor pressure toward those with low vapor pressure. If the air around the crop is contained within a chamber, it eventually becomes saturated with water vapor. At that time, evapotranspiration is negligible because the air cannot hold any additional water. If the saturated air is replaced with new dry air, evapotranspiration resumes. The more rapidly the air is exchanged and the drier the air, the higher the evapotranspiration rate. In windy, arid

Table 2-2 Albedo (percentage of incoming radiation reflected back to the atmosphere) for natural surfaces (Rosenberg 1974)

Fresh snow	0.80 – 0.95
Old snow	0.42 – 0.70
Dry Sandy soils	0.25 – 0.45
Dry clay soils	0.20 – 0.35
Peat soils	0.05 – 0.15
Most field crops	0.20 – 0.30
Forests, deciduous	0.15 – 0.20
Forests, coniferous	0.10 – 0.15
Forests, deciduous with snow on ground	0.20

locations, advection may provide as much energy for evapotranspiration as net radiation. However, in humid locations or in areas with little wind, the contribution of advection to evapotranspiration may be quite low and can be ignored for practical crop water use estimates.

Two other energy sources for evapotranspiration are the exchange of heat between the crop and the soil or between the crop and the air surrounding the crop. For example, if the soil is warmer than the crop, energy is transferred from the soil to the crop. This energy may increase transpiration. Conversely, if the canopy is warmer than the soil, energy flows toward the soil and transpiration may thus be reduced. The same energy transfer can occur between the crop and air. Crops that are not stressed for water are generally cooler than the surrounding air during the middle of the day. However, if stressed for water, the crop will often be warmer than the surrounding air.

The heat exchange between the crop and the soil, or air, is primarily important for short-term evapotranspiration estimates and is generally cyclical. On one day, the soil may receive heat, but the next, the crop may be cooler and the soil emits energy. In the long run, the net contribution of these heat exchanges to evapotranspiration is generally small.

The combined energy input into the crop-soil system can be summarized by:

$$E_I = R_n + A_d \pm S_f \pm A_h \quad [2-2]$$

where:

- E_I = net energy input
- R_n = net radiation (from solar and longwave radiation)
- A_d = advection, (from air)
- S_f = soil heat flux
- A_h = air heat flux

The basic energy balance for a soil-crop system can be written as:

$$E_I = E_{et} + P_s + A_H + S_H + C_H \quad [2-3]$$

where:

- E_{et} = energy available for evapotranspiration
- P_s = energy used for photosynthesis
- A_H = energy used to heat air
- S_H = energy used to heat soil
- C_H = energy used to heat crop

Solving for E_{et} by combining equations 2-2 and 2-3 results in:

$$E_{et} = R_n + A_d \pm S_f \pm A_h - P_s - A_H - S_H - C_H \quad [2-4]$$

When energy is introduced into the crop system, several processes occur. In response to energy inputs, the soil, air, and crop temperatures increase. A small part of the energy (about 2%) is used for photosynthesis and other reactions that occur in crop growth. The two primary energy sinks are evaporation and transpiration, or jointly evapotranspiration.

The energy balance equation describes the driving force for evapotranspiration. However, two additional factors are involved in the evapotranspiration process. First, there must be a source of water in the soil and plant to supply that used in the evapotranspiration process. Second, water must move from the soil to the point where evaporation occurs, or into and through the plant to the stomatal cavity where transpiration occurs. If the soil is dry, more resistance to water transport in the soil occurs. Also, as plants are stressed, the stomata close and the resistance to water flow in the plant increases. Therefore, evapotranspiration can be limited by either the amount of available energy or water availability in the soil.

When crop evapotranspiration (ET_c) is limited by water availability, the crop, soil, or air temperature must increase to maintain the energy balance. Changes in ET_c rates and crop temperatures are very dynamic. The values fluctuate during the day in response to small changes in the climate and in response to the water supply. Complex methods and models exist (Norman and Campbell 1982 and Campbell 1977) to calculate ET_c frequently throughout the day. These complex methods require a large number of parameters that are difficult to predict. Thus, they are primarily research tools. However, the energy balance equation and the resistance of water flow have been used for practical methods of computing or measuring ET_c . Various procedures for estimating ET_c are in sections 623.0202, 623.0203, and 623.0204.

(c) Direct measurement
of evapotranspiration

$$E_{et} = \frac{R_n}{(1 + \beta)} \quad [2-7]$$

(1) Aerodynamic methods

Aerodynamic methods involve measuring the rate of water vapor movement above the crop canopy. The vapor pressure of the air and the air flow velocities can be measured at several levels above a uniform plant canopy. By combining these measurements, the instantaneous evapotranspiration rate can be determined, and through integration of these frequent measurements, the rate of evapotranspiration for a day can be computed. Because this technique requires specialized and accurate equipment, it is generally only used for a week or less during the growing season. It is certainly not a method for unattended measurements.

A primary problem with this technique is the erratic movement of air above a crop canopy. This variability can be reduced by confining measurements to changes of air properties within a chamber placed over the location where ET_c will be measured. Probably the biggest drawback with chamber methods is that plants respond rapidly to the presence of the chamber, which alters the local climate. If the chamber remains over the plant too long, the ET_c rate and other plant responses change. Thus, chamber methods can only be used to make measurements for relatively short periods.

Another aerodynamic method involves the use of the energy balance equation (equation 2-4). This equation can be simplified by assuming that net radiation is the principal energy input. If it is also assumed that the energy used for photosynthesis, soil heating, and canopy heating is negligible, the energy balance can be written as:

$$E_{et} = R_n - A_H \quad [2-5]$$

A term called the Bowen ratio (β) is defined as:

$$\beta = \frac{A_H}{E_{et}} \quad [2-6]$$

The Bowen ratio is the ratio of the amount of energy used to heat the air relative to the amount used to evaporate water. Combining equations 2-5 and 2-6 gives:

Equipment has been developed to measure the Bowen ratio of the air that can be used with equation 2-7, along with the amount of energy required to evaporate water to estimate evapotranspiration. The primary problem with the Bowen ratio method is that advection is ignored. In many areas, this is an intolerable assumption.

(2) Soil-water methods

As soil water is the ultimate source of water used during the evapotranspiration process, several methods have been used to relate changes in soil water to crop water use. Conservation of the mass of water in the crop root zone or the soil-water balance can be used to estimate crop water use. The primary components of the soil-water balance are illustrated in figure 2-1. For onfarm irrigation, these concepts can be expressed in a revised form of the soil-water balance equation as:

$$SW_e = SW_b + P + F_g + GW - RO - D_p - ET_c \quad [2-8]$$

where:

SW_e = amount of soil water in the root zone at the end of a period

SW_b = amount of soil water in the root zone at the beginning of a period

P = total rain during the period

F_g = gross net irrigation during the period

GW = ground water contribution to water use during the period

RO = surface runoff that leaves the area during the period

D_p = deep percolation from the root zone during the period

ET_c = amount of crop evapotranspiration during the period

The ET_c or some time periods can be estimated if all other terms in equation 2-8 are measured or if sites are selected to minimize their contributions. If the ground water table is not present or is more than several feet below the soil surface, the contribution from ground water can generally be ignored. If a level location can be found, then surface runoff can be minimized. Dikes around the area can be constructed if runoff from adjacent areas is significant. Rain and

irrigation from sprinklers generally are measured with rain gauges. Measuring devices are needed for surface irrigation applications. The soil-water content is usually measured using neutron scattering techniques. Deep percolation is the most difficult component of equation 2-8 to measure.

The primary problem with the field water balance method of measuring ET_c is that several measurements must be made repetitively during the season. Because of the accuracy of the measurements, 1 week is generally the shortest reasonable period for a soil-water balance. Also, if deep percolation or runoff is significant, the application of the field water balance method is limited. Thus, for such problems or where frequent ET_c rates are needed, the representative field area generally is isolated. Lysimeters are the most common methods used to isolate the field area. They are small, fully contained tanks where changes in soil-water content caused by irrigations, rainfall, and crop evapotranspiration can be precisely measured.

(3) Lysimetry

Various types of lysimeters have been designed, constructed, and used throughout the world (fig. 2-4). One type is a nonweighing lysimeter that has an access tube installed to measure soil-water changes with neutron scattering techniques (fig. 2-4a). This lysimeter is identical to the field water balance method except that deep percolation is prevented by the bottom of the lysimeter. The controlled drainage system can be used to quantify drainage periodically.

A commonly used lysimeter in humid regions is called a water table lysimeter (figure 2-4b). With this design, deep percolation is prevented and a water table is maintained in the lysimeter. Changes in soil water and the elevation of the water table are measured along with other soil-water balance terms.

The most elaborate type of lysimeters is a weighing lysimeter (figure 2-4c). It is similar to the others except that weighing devices used to measure water

Figure 2-4 Schematic diagram of three types of lysimeters used to measure crop evapotranspiration

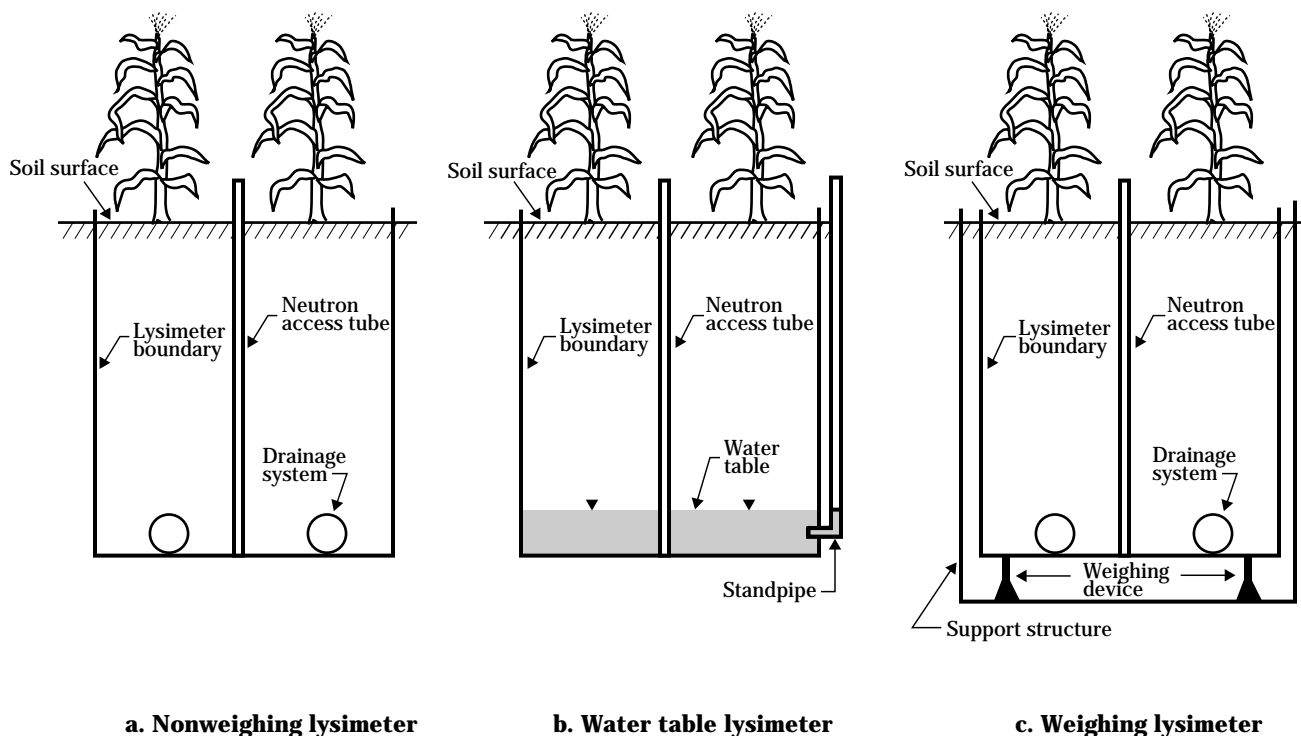

loss are installed below the lysimeter. The types of weighing devices vary considerably. The most sophisticated have high precision and can be used to measure small changes of weight. A good description of precision lysimeters is given by Marek et al. (1988).

Generally, the accurate lysimeters are precision weighing lysimeters. They have a counter balanced weighing system, resulting in a measurement accuracy approaching 0.001 inch of evapotranspiration. The high accuracy is required for daily measurements because the weight change as a result of ET_c is generally small compared to the total weight of the lysimeter and its contents. Less precise, noncounter balanced weighing lysimeters have been used to make longer term measurements. Of course, the cost of weighing lysimeters is generally much higher than that for other designs, especially for precision weighing lysimeters.

Lysimeters pose several problems in addition to their cost. The use of lysimeters to measure ET_c has been summarized by Allen et al. (1991). The best lysimeters, termed monolithic lysimeters, are those filled with an undisturbed soil column. If they are large, their filling can be difficult and expensive. Regular and careful maintenance of the lysimeter and the surrounding area is required to maintain the desired accuracy. Lysimeters can be used to measure ET_c for longer periods if precipitation and irrigation are measured. Some precision lysimeters can directly measure water additions by weight changes. Less precise lysimeters require that these additions be measured in other ways.

Measurement error and spatial variability can be significant when using lysimeters. Thus, to have confidence in the ET_c measurements, several lysimeters are needed. The more precise the lysimeter, the smaller the number of lysimeters needed. In general, lysimeters are good to excellent research tools, but presently are too complex and labor intensive to use for onfarm water management.

(4) Plant monitoring methods

The transpiration rate for crops can be measured using several techniques. One method uses a porometer. With this instrument, a small chamber is clamped onto a growing plant leaf and measurements of changes in the humidity and temperature of the air within the chamber can be used to compute the amount of transpiration during that period. The transpiration rate and other plant responses occur very rapidly because of

external factors. Therefore, the porometer can only remain on the leaf for a few minutes.

Another limitation of the porometer is that only a small part of one leaf is used for measurement. Characterizing the transpiration for an entire crop canopy requires numerous measurements. Further, these measurements only provide instantaneous transpiration rates. Generally, irrigation management requires crop water use for daily and longer periods. Thus, porometers are primarily used in experiments to investigate plant response to stress and not for crop water use estimates.

A second method uses infrared thermometers to predict transpiration based upon the difference between the crop temperature and the air temperature. These thermometers are primarily used to detect when the plant is under stress and to predict irrigation timing. However, if the incoming solar radiation and other energy terms are known, the ET_c rate can be estimated using the techniques of Hatfield (1983) and Jackson (1982). These techniques are complex and require extensive calculation as well as continuous monitoring of plant temperature. The infrared plant monitoring method can help in scheduling and managing irrigation, but it needs further development to estimate ET_c .

(5) Soil evaporation measurements

Several methods have been developed to measure soil evaporation. One method uses mini- or micro-lysimeters, which are small cylinders (generally 2 to 8 inches in diameter and 2 to 8 inches long) that are filled in a monolithic style. The devices are capped on the bottom and placed back in the field soil. Daily weighing determines the evaporation rate, and in some cases daily irrigation maintains the soil-water content in the lysimeter similar to the surrounding field conditions. In other cases the same lysimeter has been used for a longer period of drying. Lysimeters require extensive labor to measure daily evaporation and extreme care so that soil-water conditions are representative. The distribution of lysimeters must also be carefully considered where the plant canopy does not fully shade the soil.

The second method of measuring evaporation uses a soil surface psychrometer as described by Seymour and Hsiao (1984). This instrument is a smaller version, similar to the chambers used to measure ET_c . The unit

is placed on the soil surface, and the change of water vapor in the chamber is measured over time thereby providing an instantaneous rate of soil evaporation.

(6) Regional evapotranspiration methods

In some cases estimates are needed of regional evapotranspiration that occurs over a wide area. These estimates can be made indirectly using the water balance approach by measuring the inflow and outflow of ground water and surface water along with the changes of water storage in the basin. The difference in these terms represents the evapotranspiration over the entire area. Generally, the mixture of land uses and reservoir storage is not considered specifically. These methods require extensive monitoring and several years of data to provide acceptable accuracy. Generally, basin water balance techniques are only accurate for relatively long-term evapotranspiration estimates.

A second method to determine regional evapotranspiration using infrared images from satellites and other high altitude systems is currently being developed. The techniques used to predict evapotranspiration for these large regions are based on the same concepts as the plant monitoring system using a hand held infrared thermometer. The complex map of temperature of the Earth's surface must be processed to integrate water use across the area. Once perfected, these methods may provide useful information on the rate of evapotranspiration at the time the image is taken. However, much additional work is needed to estimate the total evapotranspiration for a shorter period. This will be especially difficult if satellite images are not available on a frequent basis. Their projected use at the current time is the determination of the crop water status for a multitude of crops and for updating yield estimates.

Regional evapotranspiration methods are generally used for hydrological or crop forecasting purposes. Currently, the methods are not refined enough to predict crop water use for fields on a continual basis. That might be possible in the future, but considerable research is still needed before that type of information is available.

(7) Summary

Direct measurement of evapotranspiration requires special equipment and training. The measurements generally are time consuming, have severe limitations, and are too expensive for wide scale use in determining actual crop water use. Generally, the methods

require several years of experimentation to determine crop water use. Direct measurement of ET_c is generally not used for irrigation scheduling, design, or management. However, these techniques have been successfully used to develop more practical ways of estimating ET_c . They have been used in research to develop and calibrate several types of equations to compute ET_c for a wide range of conditions. The equations recommended for predicting crop water use are described in sections 623.0202, 623.0203, and 623.0204.

(d) Estimating crop evapotranspiration

Many methods have been developed to estimate the rate of ET_c based on climatic factors. The simplest methods generally use the average air temperature. The most complex methods require hourly data for solar radiation, air temperature, wind speed, and the vapor pressure. Many approaches are between these extremes. All methods of predicting ET_c require some information about the rate of crop canopy development.

After considering various approaches, the reference crop method is recommended for a unified procedure that has proven accurate for many locations. The reference crop evapotranspiration method uses two factors to predict actual crop water use:

$$ET_c = (K_c)(ET_o) \quad [2-9]$$

where:

ET_c = actual crop evapotranspiration rate

K_c = crop coefficient

ET_o = evapotranspiration rate for a grass reference crop

The reference crop is generally represented by either grass or alfalfa. Well watered and healthy grass clipped to a height of 3 to 6 inches has been widely used. Well watered and healthy alfalfa at least 12 inches tall has been used in the Western United States.

The primary purpose of this publication is to provide a means to compute reasonable estimates of crop water use for irrigation. To reduce confusion and provide consistency, grass will be used for the reference crop

in this chapter. Four methods to predict ET_0 are presented in section 623.0203. All methods rely on climatic measurements. Climatic relationships needed to process climatic measurements are presented in 623.0202.

The crop coefficient (K_c) in equation 2-9 relates the actual crop water use to that of the grass reference crop. The value of the crop coefficient generally is small when the plant canopy is small and only partly shades the soil surface. Most of the crop water use at this time is from evaporation from the soil surface. As the canopy develops, more radiation is absorbed by the crop; thus, the transpiration rate of the crop increases. When the crop completely shades the soil surface, the crop coefficient may exceed 1.0. That is, the water use of the actual crop may be larger than that used by the grass reference crop because of the increased leaf area and a taller crop. As the season progresses and the crop begins to senesce, the value of the crop coefficient will begin to decrease.

Crop coefficients depend on specific crops and soil factors. In addition, the water use for daily versus monthly estimates require that the crop coefficient be calculated differently depending on the length of the estimate period. Also, the effect of soil moisture stress and a wet soil surface on the actual crop water use rate may be important for such applications as irrigation scheduling. Finally, methods are needed to verify that the crop coefficient is adjusted for the effects of weather patterns that may cause rapid or delayed crop growth. Because of the importance and unique nature of crop coefficients, they are described in more detail in section 623.0204.

Because the traditional Modified Blaney-Criddle method in SCS Technical Release 21 is used throughout the Western United States, it is described in the appendix to this chapter. In some areas the allotment of water rights is based on this method; therefore, it is important to retain this method. However, because of improved accuracy and consistency, the reference crop techniques are recommended.

623.0202 Climatic relationships and data

(a) Introduction

The crop evapotranspiration rate is determined by the amount of energy available to evaporate water. The amount of energy is represented by the reference crop evapotranspiration rate. Methods that use climatic information to predict the amount of reference crop evapotranspiration have been developed. Generally, the climatic information that is measured at weather stations is not used directly in the methods for computing reference crop evapotranspiration. The climatic properties and relationships used to process data measured at weather stations for computing reference crop evapotranspiration are presented in this section.

An example site is used to illustrate the calculations involved in using the climatic relationships. The site is representative of an area near Dodge City, Kansas. Monthly and annual weather parameters are given for this site in table 2-3.

(b) Barometric pressure

The atmospheric pressure, or barometric pressure, results from the force exerted by the weight of vapors, or gases, in the air. The Earth's gravitational pull is stronger at low elevations than at higher elevations above sea level. Under standard conditions, the average atmospheric pressure at sea level is about 14.7 pounds per square inch (psi), while at an elevation of 2,600 feet above sea level, the mean atmospheric pressure is about 13.4 psi. In evapotranspiration studies, pressures are commonly expressed in units of millibars (mb). One psi is equal to about 69 mb; thus, the atmospheric pressure under standard conditions would be 1,013 mb at sea level and 920 mb at 2,600 feet above sea level. The mean barometric pressure can be calculated by:

$$BP = 1.013 \left[1 - \frac{E_{lev}}{145,350} \right]^{5.26} \quad [2-10]$$

where:

BP = barometric pressure (mb)

E_{lev} = elevation above sea level (ft)

Table 2-3 Average daily value of climatic parameters for an example site near Dodge City, Kansas^{1/}—latitude: 37°46' N; longitude: 99°58' W; elevation: 2,600 feet

Month	----- Air temperature, °F -----				Solar radiation (lang/d)	Sunshine fraction (n/N)	Wind run ^{2/} (mi/d)	Mean relative humidity (%)	Mean precipitation (in)
	Maximum	Minimum	Mean	Mean dew point					
January	45	20	32.5	18	255	0.67	260	65	0.46
February	49	23	36.0	23	316	0.66	260	62	0.57
March	55	30	42.5	25	418	0.68	296	60	0.83
April	68	41	54.5	36	528	0.68	296	60	1.67
May	77	51	64.0	49	568	0.68	278	64	3.07
June	88	61	74.5	57	650	0.74	260	61	2.59
July	93	67	80.0	61	642	0.78	244	58	2.25
August	92	66	79.0	59	592	0.78	244	59	2.44
September	83	56	69.5	51	493	0.76	260	56	1.31
October	74	45	59.5	41	380	0.75	244	60	1.20
November	57	30	43.5	29	285	0.70	260	60	0.66
December	45	23	34.0	22	234	0.67	244	64	0.47
Annual	69	43	56.0	39	447	0.71	262	61	17.50

1/ Source: United States Department of Commerce (1977).

2/ Wind speeds were originally measured at a 10 m height, but have been adjusted to a standard height of 2 m for this example.

(c) Air properties

Air is composed of several gases, one of which is water vapor. The amount of water vapor present in air is often characterized using the relative humidity (RH). RH is an index of the amount of water vapor present in the air compared to the maximum amount of water the air could hold at its current temperature. Thus, the relative humidity of the air changes as the temperature of the air changes. If the amount of water vapor in the air remains constant, but the temperature increases, RH decreases because warm air can hold more water vapor than cool air. Because RH is so dependent on temperature, it is not very useful for evapotranspiration calculations. A more useful parameter to describe the amount of water vapor in the air is the vapor pressure (e), which is the partial pressure of the water vapor in the atmosphere.

As the relative humidity increases, the vapor pressure also increases. Where the air is saturated with water vapor, the relative humidity will be 100 percent and the vapor pressure will have reached the maximum value for that temperature. The maximum vapor pressure, called the saturated vapor pressure, is denoted by e° . Similar to relative humidity, the saturated vapor pressure depends on temperature. The saturated vapor pressure can be computed using an equation simplified from that presented by Jensen, et al. (1990):

$$e^{\circ} = \left(\frac{164.8 + T}{157} \right)^8 \quad [2-11]$$

where:

e° = saturated vapor pressure (mb)

T = air temperature ($^{\circ}\text{F}$)

The value of the saturated vapor pressure as a function of air temperature is shown in figure 2-5. This figure also shows the vapor pressure at various relative humidities as a function of temperature.

Air generally is not saturated with water vapor (i.e., at 100% relative humidity). An example of air at a temperature of 70 $^{\circ}\text{F}$ and 40 percent relative humidity is shown in figure 2-5. The actual vapor pressure for this condition is about 10 mb. The saturated vapor pressure at 70 $^{\circ}\text{F}$ is 25 mb. Using these data, the relationship between relative humidity and vapor pressure can be illustrated:

$$RH = \left(\frac{e}{e^{\circ}} \right) 100 \quad [2-12]$$

where:

RH = relative humidity (%)

e = actual vapor pressure (mb)

e° = saturated vapor pressure (mb)

Another important property of air called the dew point temperature is shown in figure 2-5. The dew point is the temperature at which water vapor in the air condenses and forms dew. If air at 70 $^{\circ}\text{F}$ and 40 percent relative humidity was cooled to the dew point (45 $^{\circ}\text{F}$), water would begin to condense.

Figure 2-5 Relationship of vapor pressure and relative humidity to temperature

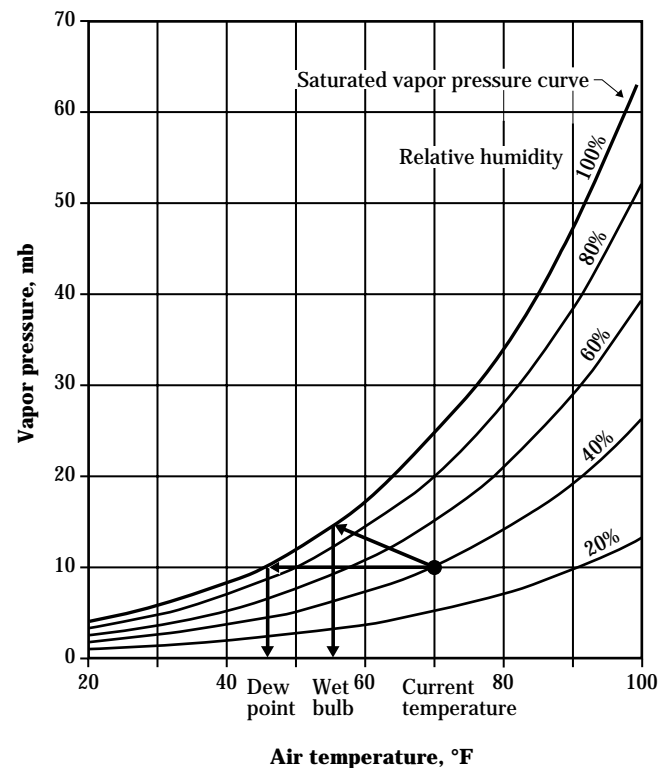

The vapor pressure for the current air conditions is the same as the saturated vapor pressure at the dew point temperature. The saturated vapor pressure at the dew point is generally represented by e_d . The dew point vapor pressure can be calculated using the saturated vapor pressure equation and the dew point temperature. In processing data from weather stations, it is necessary to compute the dew point temperature from the measured vapor pressure. Equation 2-11 can be rearranged for this purpose to give:

$$T_d = 157(e)^{0.125} - 164.8 \quad [2-13]$$

where:

- T_d = dew point temperature ($^{\circ}\text{F}$)
 e = vapor pressure of the air (mb)

Example 2-1 illustrates the use of these equations.

The energy available in dry air to evaporate water is characterized by the difference between the saturated vapor pressure of the air and the actual vapor pressure of the air. This difference is called the vapor pressure deficit and is expressed as:

$$e_z^{\circ} - e_z$$

The variable e_z° is the average saturated vapor pressure for the day when measured at a height z above the soil. Several methods have been used to compute e_z° . The method used in this chapter is to compute the

Example 2-1 Dew point

Given: Suppose a measurement of the air gave the temperature (T) to be 80°F and the relative humidity (RH) to be 60 percent.

Compute: a) the saturated vapor pressure (e°),
 b) the actual vapor pressure (e), and
 c) the dew point temperature (T_d).

Solution: a) Calculation of saturated vapor pressure e° , use equation 2-11

$$e^{\circ} = \left(\frac{164.8 + 80}{157} \right)^8$$

$$e^{\circ} = 34.9 \text{ mb}$$

b) Calculation of the actual vapor pressure e , use equation 2-12

$$\text{RH} = \left(\frac{e}{e^{\circ}} \right) 100$$

$$e = e^{\circ} \frac{\text{RH}}{100}$$

$$e = (34.9 \text{ mb}) \times \left(\frac{60}{100} \right)$$

$$e = 20.9 \text{ mb}$$

c) Calculation of the dew point temperature T_d , use equation 2-13

$$T_d = 157(20.9)^{0.125} - 164.8$$

$$T_d = 64.8^{\circ}\text{F}$$

mean saturated vapor pressure for the daily maximum and minimum air temperature:

$$e_z^o = \frac{1}{2} \left(e_{T_{\max z}}^o + e_{T_{\min z}}^o \right) \quad [2-14]$$

where:

$e_{T_{\max z}}^o$ = saturated vapor pressure for the maximum daily air temperature that is measured at height z

$e_{T_{\min z}}^o$ = saturated vapor pressure for the minimum daily air temperature that is measured at height z

It is very important that this procedure is used to compute the vapor pressure deficit. A shortcut that is sometimes followed is to use the average air temperature to compute e_z^o . This should **not** be done because the reference crop evapotranspiration will consistently under predict crop water use. Using the average temperature in the vapor pressure deficit (example 2-2) would give $e_z^o = 29.1$ mb. The resulting vapor pressure deficit would then be $29.1 - 15.9$ mb = 13.2 mb. This error is very serious especially when the air is dry and the wind speed is high. The procedure used in example 2-2 should be followed in the handbook.

Example 2-2 helps illustrate the calculation. The actual vapor pressure is equal to the saturated vapor pressure at the daily dew point temperature:

$$e_z = e_d \quad [2-15]$$

Example 2-2 Vapor pressure deficit

Compute: The average vapor pressure deficit for the example site in June.

Solution: Saturated vapor pressure equation, equation 2-11:

$$\left(\frac{164.8 + T}{157} \right)^8$$

maximum air temperature = $88^\circ\text{F} \rightarrow e_{T_{\max z}}^o = 45.2$ mb

minimum air temperature = $61^\circ\text{F} \rightarrow e_{T_{\min z}}^o = 18.3$ mb

$$e_z^o = \frac{1}{2} (45.2 + 18.3) \text{ mb}$$

$$e_z^o = 31.8 \text{ mb}$$

dew point temperature = $57^\circ\text{F} \rightarrow e_z = 15.9$ mb

vapor pressure deficit = $(e_z^o - e_z) = 31.8 - 15.9$ mb

$$= (e_z^o - e_z) = 15.9 \text{ mb}$$

Some of the methods used to compute reference crop evapotranspiration depend on the slope of the saturated vapor pressure curve with respect to air temperature. The slope of the vapor pressure curve is represented by Δ and can be calculated as:

$$\Delta = 0.051 \left(\frac{164.8 + T}{157} \right)^7 \quad [2-16]$$

where:

- Δ = slope of vapor pressure curve (mb/°F)
- T = air temperature (°F)

Another necessary parameter for reference crop evapotranspiration methods is the psychrometric constant (γ). This parameter is derived from the use of psychrometers to measure air properties. A psychrometer has two thermometers. One is a traditional thermometer that measures the air temperature. The second thermometer is covered with a wick that is wetted with water when in use. When air is forced past the psychrometer, the wetted thermometer is cooled by the evaporation of water. This temperature, referred to as the *wet bulb* temperature, is denoted by T_w . Water will evaporate until the vapor pressure of the air reaches the saturated vapor pressure at the wet bulb temperature. This process is graphically illustrated in figure 2-5.

When using the psychrometer, the energy to evaporate the water comes from the cooling of the air from the normal, i.e., dry bulb, temperature to the wet bulb temperature. The change of energy can also be represented by the change of vapor pressure by using the psychrometer constant. The result of that expression gives the definition of the psychrometer constant:

$$\gamma_c = \left(\frac{e_w^o - e}{T - T_w} \right) \quad [2-17]$$

where:

- γ_c = psychrometer constant (mb/°F)
- e_w^o = saturated vapor pressure at the wet bulb temperature (mb)
- e = vapor pressure of the air (mb)
- T_w = wet bulb temperature (°F)
- T = air temperature (°F)

The psychrometer constant equals a theoretical value called the psychrometric constant (γ) if the psychrometer is perfectly designed and used. The psychrometric constant can be computed as:

$$\gamma = c_p \frac{BP}{0.622\lambda} \quad [2-18]$$

where

- γ = psychrometric constant (mb/°F)
- c_p = specific heat of dry air (lang/in/°F)
- BP = mean barometric pressure (mb)
- λ = heat of vaporization (lang/in of water)

The specific heat is the amount of energy needed to raise a unit of air one degree and equals 0.339 lang/in/°F.

The heat of vaporization of water (λ) is the amount of energy needed to evaporate a unit of water. It depends on the air temperature and is given by:

$$\lambda = 1,543 - 0.796 T \quad [2-19]$$

where:

- λ = heat of vaporization of water (langs/in)
- T = air temperature (°F)

For the air temperature of 70 °F as shown in figure 2-5, the heat of vaporization equals 1,487 langleys per inch. If these conditions were at sea level, where BP=1,013 mb, the psychrometric constant would be 0.37 mb/°F. As shown in figure 2-5, this gives a wet bulb temperature of about 56 °F and a saturated vapor pressure at the wet bulb temperature of 15.3 mb.

(d) Wind relationships

The wind speed profile within and above a crop canopy is illustrated in figure 2-6. The wind speed decreases rapidly with depth into the canopy. Above the crop canopy, the wind speed can be described using a logarithmic profile. To describe the logarithmic profile, the roughness parameter (Z_o) and the zero plane displacement (d) are used. Using these definitions, the wind speed (U) above the crop canopy can be described as:

$$U = \left(\frac{U^*}{k} \right) \text{LN} \left(\frac{Z-d}{Z_o} \right) \quad [2-20]$$

where:

- U = wind velocity at height Z (mi/hr)
- U^* = representative friction velocity (mi/hr)
- k = von Karman's constant = 0.41
- LN = natural logarithm
- Z = height above the soil surface (ft)
- Z_o = roughness parameter (ft)
- d = zero plane displacement (ft)

Allen (1986) showed that the roughness parameter and the zero plane displacement were proportional to the crop height:

$$Z_o = 0.01025 h_c \quad [2-20a]$$

$$d = \frac{h_c}{18} \quad [2-20b]$$

where:

- h_c = crop height (in)

The representative friction velocity (U^*) is a theoretical parameter representing the characteristics of a crop. The value is difficult to measure and is seldom directly used in practical applications.

Equation 2-20 is not used directly, but instead is used to relate the wind speed at one height to the wind speed at another height. This adjustment is often necessary because some equations for estimating reference crop evapotranspiration are developed for wind speeds measured at a specified height. However, wind speeds at the local weather station may be measured at a different height.

The following factor can be developed to adjust for differences in measurement elevations:

$$U_2 = U_f U_1 \quad [2-21]$$

where:

- U_2 = estimated wind speed at height Z_2
- U_f = adjustment factor for wind speed
- U_1 = measured wind speed at height Z_1

The adjustment factor (U_f) depends on the heights of the wind speed measurement, the desired height, and the height of the crop growing at the weather station where wind speed U_1 was measured:

$$U_f = \frac{\text{LN} \left(97.56 \left[\frac{Z_2}{h_c} \right] - 5.42 \right)}{\text{LN} \left(97.56 \left[\frac{Z_1}{h_c} \right] - 5.42 \right)} \quad [2-22]$$

where:

- U_f = adjustment factor
- Z_2 = desired height (ft)
- Z_1 = height at the weather station (ft)
- h_c = crop height (in)

Values of the adjustment factor (U_f) are summarized in table 2-4 for various values of measuring heights and weather station crop heights.

Figure 2-6 Representation of wind speeds within and above a crop canopy

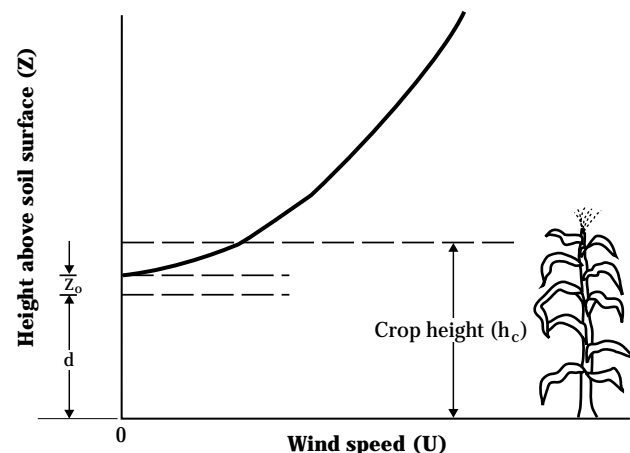

Table 2-4 Ratio of wind speeds based on measurement heights ^{1/}

Old wind height Z_1 (ft)	4	5	6	New wind height Z_2 (ft) 6.6	7	8	9	9.8
----- Height of crop at weather station = 5 inches -----								
4	1.00	1.06	1.11	1.13	1.15	1.18	1.21	1.23
5	0.94	1.00	1.04	1.07	1.08	1.11	1.14	1.16
6	0.90	0.96	1.00	1.02	1.04	1.07	1.09	1.11
6.6	0.88	0.94	0.98	1.00	1.02	1.05	1.07	1.09
7	0.87	0.92	0.97	0.99	1.00	1.03	1.06	1.08
8	0.85	0.90	0.94	0.96	0.97	1.00	1.03	1.04
9	0.83	0.87	0.91	0.93	0.95	0.98	1.00	1.02
9.8	0.81	0.86	0.90	0.92	0.93	0.96	0.98	1.00
----- Height of crop at weather station = 12 inches -----								
4	1.00	1.08	1.14	1.17	1.19	1.24	1.28	1.31
5	0.93	1.00	1.06	1.09	1.11	1.15	1.18	1.21
6	0.88	0.94	1.00	1.03	1.05	1.08	1.12	1.14
6.6	0.85	0.92	0.97	1.00	1.02	1.06	1.09	1.11
7	0.84	0.90	0.96	0.98	1.00	1.04	1.07	1.09
8	0.81	0.87	0.92	0.95	0.96	1.00	1.03	1.05
9	0.78	0.84	0.89	0.92	0.93	0.97	1.00	1.02
9.8	0.77	0.83	0.87	0.90	0.91	0.95	0.98	1.00
----- Height of crop at weather station = 18 inches -----								
4	1.00	1.10	1.18	1.22	1.25	1.30	1.35	1.39
5	0.91	1.00	1.07	1.11	1.13	1.18	1.23	1.26
6	0.84	0.93	1.00	1.03	1.06	1.10	1.14	1.17
6.6	0.82	0.90	0.97	1.00	1.02	1.07	1.10	1.14
7	0.80	0.88	0.95	0.98	1.00	1.04	1.08	1.11
8	0.77	0.85	0.91	0.94	0.96	1.00	1.04	1.06
9	0.74	0.82	0.88	0.90	0.92	0.96	1.00	1.03
9.8	0.72	0.79	0.85	0.88	0.90	0.94	0.97	1.00
----- Height of crop at weather station = 24 inches -----								
4	1.00	1.13	1.24	1.28	1.32	1.39	1.44	1.49
5	0.88	1.00	1.09	1.13	1.16	1.22	1.27	1.31
6	0.81	0.92	1.00	1.04	1.07	1.12	1.17	1.20
6.6	0.78	0.88	0.96	1.00	1.03	1.08	1.13	1.16
7	0.76	0.86	0.94	0.97	1.00	1.05	1.10	1.13
8	0.72	0.82	0.89	0.93	0.95	1.00	1.04	1.07
9	0.69	0.79	0.86	0.89	0.91	0.96	1.00	1.03
9.8	0.67	0.76	0.83	0.86	0.89	0.93	0.97	1.00

1/ Wind speeds are commonly measured at either 2 or 3 meters above the soil surface. These heights correspond to 6.6 and 9.8 feet, respectively.

Another value needed to compute evapotranspiration is the daytime wind speed (U_d). This speed can be estimated from the total miles of wind run per day and the ratio of the average wind speed during the day to the average wind speed at night:

$$U_d = \frac{UU_r}{12(1 + U_r)} \quad [2-23]$$

where:

U_d = daytime wind speed (mi/hr)

U = daily wind run (mi/d)

U_r = ratio of daytime to nighttime wind speeds

Doorenbos and Pruitt (1977) suggest a default value of 2 for U_r if local information is unavailable. Values of U_d for various daily wind runs and ratios of daytime to nighttime wind speed are summarized in table 2-5. An example of adjustments needed to use wind measurements is given in the example 2-3.

Example 2-3 Wind speed computations

Given: Suppose a total wind run of 300 miles per day was measured with an anemometer located 3 meters (9.8 feet) above the soil surface. In this area, the average daytime to nighttime wind speeds ratio is about 2. The grass at the weather station is maintained at 6 inches tall.

Compute:

- The daily wind run for a height of 2 meters (6.6 feet).
- The average daytime wind speed.

Solution:

- The wind adjustment factor (U_f) for these conditions is determined from table 2-4 as 0.92. Then the wind run at 2 m would be computed from:

$$U_{2m} = U_f U_{3m}$$

$$U_{2m} = (0.92) \times (300 \text{ miles / day})$$

$$U_{2m} = 276 \text{ miles / day}$$

- Using the bottom of table 2-5 gives:

$$U_d = 0.0556 \times 276$$

$$U_d = 15.3 \text{ miles / hour}$$

This compares well with the value in table 2-5 for 280 miles per day.

Table 2-5 Daytime wind speed (U_d) in miles per hour

Daily wind run (U), (mi/d)	Ratio of daytime to nighttime wind speed (U_p)							
	0.5	1.0	1.5	2.0	2.5	3.0	3.5	4.0
0	0.0	0.0	0.0	0.0	0.0	0.0	0.0	0.0
20	0.6	0.8	1.0	1.1	1.2	1.3	1.3	1.3
40	1.1	1.7	2.0	2.2	2.4	2.5	2.6	2.7
60	1.7	2.5	3.0	3.3	3.6	3.8	3.9	4.0
80	2.2	3.3	4.0	4.4	4.8	5.0	5.2	5.3
100	2.8	4.2	5.0	5.6	6.0	6.3	6.5	6.7
120	3.3	5.0	6.0	6.7	7.1	7.5	7.8	8.0
140	3.9	5.8	7.0	7.8	8.3	8.8	9.1	9.3
160	4.4	6.7	8.0	8.9	9.5	10.0	10.4	10.7
180	5.0	7.5	9.0	10.0	10.7	11.3	11.7	12.0
200	5.6	8.3	10.0	11.1	11.9	12.5	13.0	13.3
220	6.1	9.2	11.0	12.2	13.1	13.8	14.3	14.7
240	6.7	10.0	12.0	13.3	14.3	15.0	15.6	16.0
260	7.2	10.8	13.0	14.4	15.5	16.3	16.9	17.3
280	7.8	11.7	14.0	15.6	16.7	17.5	18.1	18.7
300	8.3	12.5	15.0	16.7	17.9	18.8	19.4	20.0
320	8.9	13.3	16.0	17.8	19.0	20.0	20.7	21.3
340	9.4	14.2	17.0	18.9	20.2	21.3	22.0	22.7
360	10.0	15.0	18.0	20.0	21.4	22.5	23.3	24.0
380	10.6	15.8	19.0	21.1	22.6	23.8	24.6	25.3
400	11.1	16.7	20.0	22.2	23.8	25.0	25.9	26.7
420	11.7	17.5	21.0	23.3	25.0	26.3	27.2	28.0
440	12.2	18.3	22.0	24.4	26.2	27.5	28.5	29.3
460	12.8	19.2	23.0	25.6	27.4	28.8	29.8	30.7
480	13.3	20.0	24.0	26.7	28.6	30.0	31.1	32.0
500	13.9	20.8	25.0	27.8	29.8	31.3	32.4	33.3
520	14.4	21.7	26.0	28.9	31.0	32.5	33.7	34.7
540	15.0	22.5	27.0	30.0	32.1	33.8	35.0	36.0
560	15.6	23.3	28.0	31.1	33.3	35.0	36.3	37.3
580	16.1	24.2	29.0	32.2	34.5	36.3	37.6	38.7
600	16.7	25.0	30.0	33.3	35.7	37.5	38.9	40.0
620	17.2	25.8	31.0	34.4	36.9	38.8	40.2	41.3
640	17.8	26.7	32.0	35.6	38.1	40.0	41.5	42.7
660	18.3	27.5	33.0	36.7	39.3	41.3	42.8	44.0
680	18.9	28.3	34.0	37.8	40.5	42.5	44.1	45.3
700	19.4	29.2	35.0	38.9	41.7	43.8	45.4	46.7
720	20.0	30.0	36.0	40.0	42.9	45.0	46.7	48.0

For daily wind runs not listed in the first column, multiply U by the factor below to get U_d :

0.0278 0.0417 0.0500 0.0556 0.0595 0.0625 0.0648 0.0667

(e) Estimating net radiation

In many locations, solar radiation provides the majority of the energy used to evaporate water. Solar radiation is so important that it currently is being measured at many locations throughout the world. In other locations, it may be necessary to estimate solar radiation from observed data. This section reviews several methods of determining solar radiation.

Ultimately, net radiation (R_n) must be predicted from observations of solar radiation (R_s). The basic method of Wright (1982) is used here to predict net radiation:

$$R_n = (1 - \alpha)R_s - R_b \quad [2-24]$$

where:

- R_n = net radiation (lang/d)
- α = albedo of crop and soil surface
- R_s = incoming solar radiation (lang/d)
- R_b = net outgoing longwave radiation (lang/d)

All radiation quantities used in the chapter are expressed in units of langleys per day, which will be abbreviated by lang/d.

At this point, it is assumed that the solar radiation (R_s) has been measured. Methods to estimate R_s are presented later in the section. To estimate net radiation, the albedo for a grass reference crop and the net outgoing longwave radiation must be determined.

The albedo (α) is the fraction of the incoming short-wave solar radiation that is reflected from the soil and crop surface back into the atmosphere. The albedo depends on the angle between the Sun's rays and a horizontal plane at the Earth's surface. This angle is called the solar altitude and varies for the day of the year, time of day, and latitude of the location. Dong, Grattan, Carroll, and Prashar (1992) developed a method to estimate hourly net radiation during the daytime for well watered grass. Their results were used to estimate the mean daytime albedo for a grass reference crop. The expression for the mean daytime albedo is based on the solar altitude when the Sun reaches the maximum height during the day, or at solar noon. The resulting expression for the mean daytime albedo is:

$$\alpha = 0.108 + 0.000939 \theta_m + 0.257 \text{ EXP} \left(-\frac{\theta_m}{57.3} \right) \quad [2-25]$$

where:

- α = the mean daytime albedo for a grass reference crop
- θ_m = solar altitude at solar noon for the current day
- EXP = the exponential function

The solar altitude is computed based on the relationships given by Dvoracek and Hannabas (1990):

$$\theta_m = \text{SIN}^{-1}(\text{SIN } \theta_d \text{ SIN Lat} + \text{COS } \theta_d \text{ COS Lat}) \quad [2-26]$$

and

$$\theta_d = \text{SIN}^{-1} \left[0.39795 \text{ COS} (0.98563(\text{DOY} - 173)) \right] \quad [2-27]$$

where:

- θ_m = solar altitude at solar noon (degrees)
- θ_d = solar declination angle (degrees)
- Lat = latitude (degrees)
- DOY = the day of the year

The solar declination is the angular distance of the sun north (+) or south (-) of the equator. The declination angle is zero at the time of the vernal equinox (about March 21) and autumnal equinox (about September 23). The declination angle reaches a maximum value of 23.5° at the time of the summer solstice (about June 22).

The procedure described in equation 2-25 is not applicable when overcast conditions cause very diffuse insolation. For overcast conditions, when the ratio of $R_s/R_{so} \leq 0.7$, the albedo for a grass reference crop is about 0.26.

The value of the albedo as a function of the time of year for northern latitudes is shown in figure 2-7. The albedo reaches a minimum during the summer primarily because of the angle of the Sun.

The net outgoing longwave radiation (R_b) is generally estimated based on the amount of cloud cover and the emissivity of the atmosphere. Wright (1982) predicts the net outgoing longwave radiation as:

$$R_b = \left(a \frac{R_s}{R_{so}} + b \right) R_{bo} \quad [2-28]$$

where:

R_{so} = the amount of incident solar radiation on a clear day

R_{bo} = the net outgoing longwave radiation on a clear day

The parameters a and b in equation 2-28 depend on the amount of cloud cover: If

$$\frac{R_s}{R_{so}} > 0.7$$

a = 1.126 and b = -0.07, and

$$\text{when } \frac{R_s}{R_{so}} \leq 0.7$$

a = 1.017 and b = -0.06

Figure 2-7 Variation of albedo during the year for selected latitudes

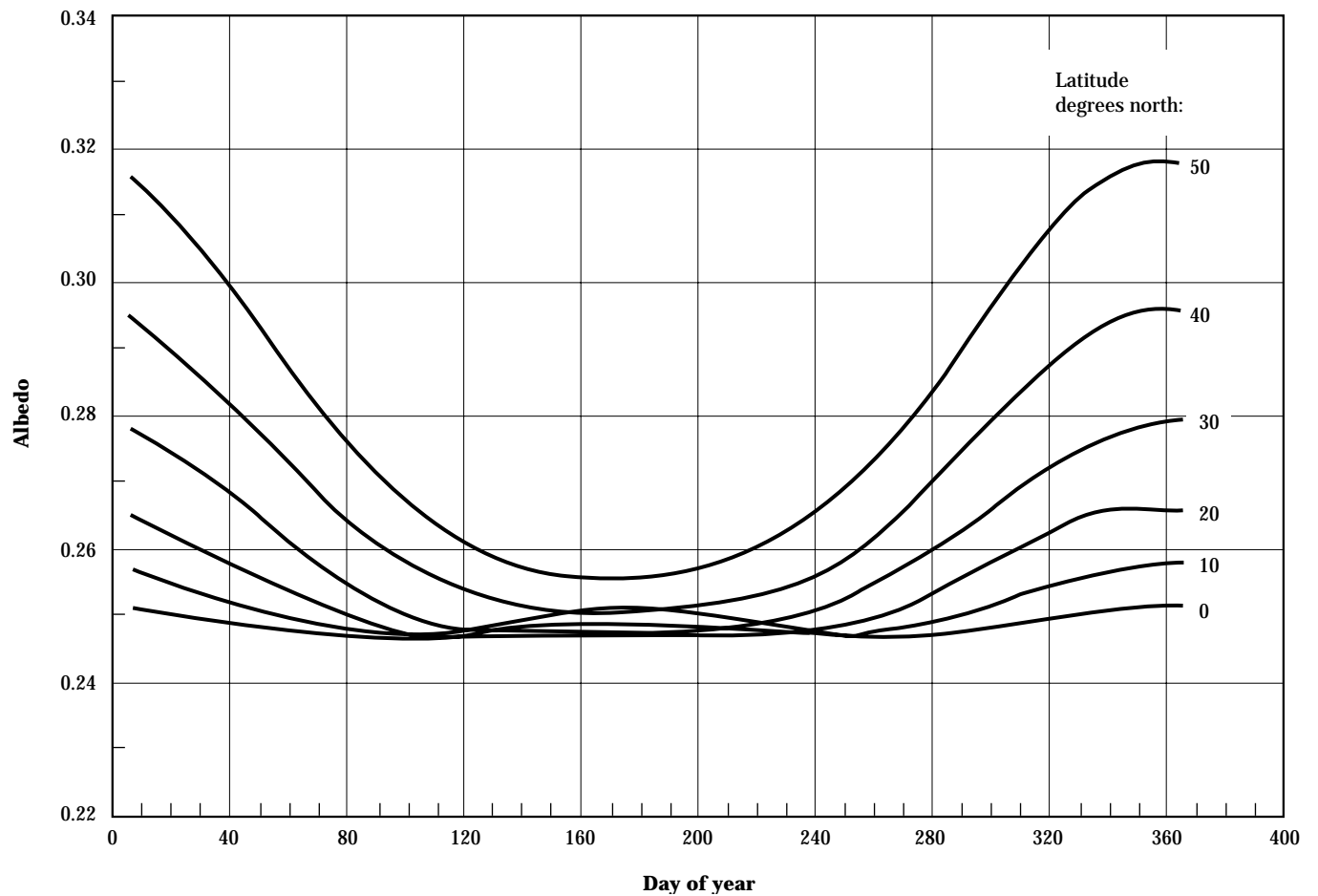

The amount of clear sky solar radiation (R_{so}) and the net outgoing longwave radiation (R_{bo}) on a clear day are generally predicted using empirical equations. Heermann, et al. (1985) developed an equation to predict the clear sky radiation based upon the latitude, elevation above sea level, and the time of year. An example for this function is given in figure 2-8. The equation to describe the clear sky shortwave radiation can be expressed by:

$$R_{so} = A + B \cos[0.9863(\text{DOY} - 170)] \quad [2-29]$$

where:

$$A = 753.6 - 6.53 \text{ Lat} + 0.0057 E_{lev}$$

$$B = -7.1 + 6.40 \text{ Lat} + 0.0030 E_{lev}$$

DOY = day of the year (1-365)

Lat = latitude ($^{\circ}\text{N}$)

E_{lev} = elevation above sea level (ft)

The COS function is evaluated in the degrees mode.

Figure 2-8 Effect of date and elevation on clear sky radiation at 40°N latitude

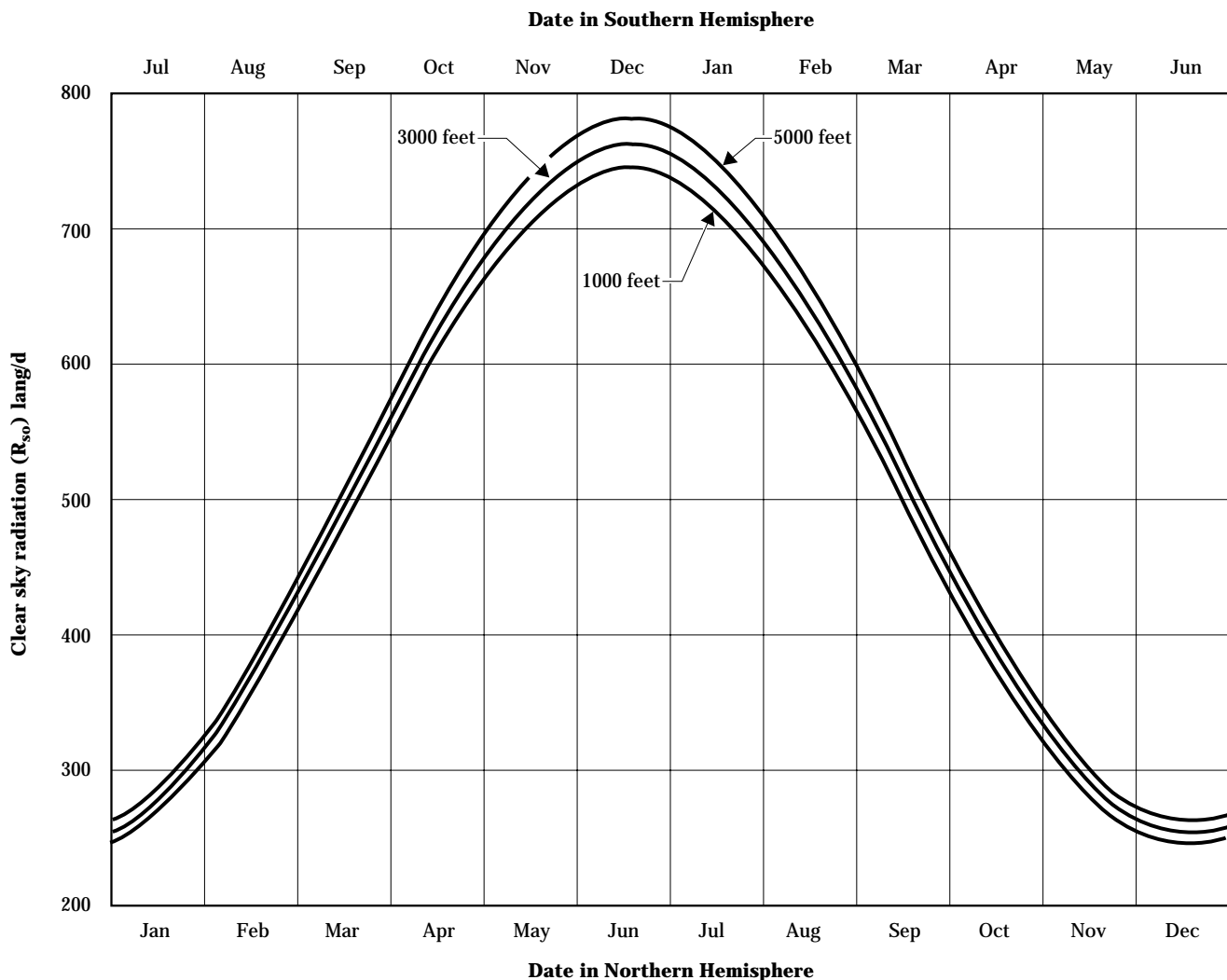

Equation 2-29 is difficult to express in one table so the equation has been changed to:

$$R_{so} = R_{so}^o + R_{so}^e \quad [2-30]$$

where:

R_{so}^o = clear sky radiation at sea level

R_{so}^e = clear sky radiation correction term for elevation

Values for R_{so}^o and R_{so}^e are summarized in tables 2-6 and 2-7. Example 2-4 illustrates how to compute clear sky radiation.

The net outgoing longwave radiation on a clear day (R_{bo}) depends on emissivity of the atmosphere (ϵ') and the temperature of the crop and soil. These temperatures generally are estimated and are called the temperature at the earth's surface. The general equation to describe R_{bo} is given by:

$$R_{bo} = \epsilon' \sigma T_s^4 \quad [2-31]$$

where:

ϵ' = net atmospheric emittance,

σ = Stephan-Boltzman constant, 11.71×10^{-8} lang/(day °K⁴)

T_s = effective absolute temperature of the earth's surface (°K)

The effective temperature of the Earth's surface is calculated as:

$$T_s^4 = \frac{1}{2} \left[\left(\frac{5}{9} T_{\max} + 255.4 \right)^4 + \left(\frac{5}{9} T_{\min} + 255.4 \right)^4 \right] \quad [2-32]$$

where:

T_{\max} = daily maximum temperature (°F)

T_{\min} = daily minimum temperature (°F)

Example 2-4 Clear sky radiation (R_{so})

Compute: The clear sky radiation at the example site near Dodge City, KS, for June, July, and August.

Solution:

Elevation at Dodge City = 2,600 feet

Latitude at Dodge City = 38° N

Use interpolation to determine R_{so}^o for 38° N from table 2-6.

Interpolate in table 2-7 to determine R_{so}^e for 2,600 feet.

	R_{so}^o (lang/d)	R_{so}^e (lang/d)	R_{so} (lang/d)
June 10	738	22.5	761
July 10	726	22.1	748
August 10	653	19.7	673

Table 2-6 Clear sky radiation at sea level for various latitudes and dates

Month	Day	Degrees N latitude						
		0	10	20	30	40	50	60
		----- R_{sc}^o (lang/d) -----						
January	1	761	633	505	378	250	123	
	10	760	636	511	386	262	137	13
	20	760	640	521	401	281	162	42
February	1	759	647	536	424	313	202	90
	10	758	654	550	446	342	238	134
	20	757	662	567	473	378	283	189
March	1	756	670	585	499	413	328	242
	10	755	679	603	527	451	375	299
	20	754	689	624	558	493	428	363
April	1	752	700	648	596	544	493	441
	10	751	709	666	624	581	539	497
	20	750	717	685	652	620	587	555
May	1	749	726	703	681	658	635	612
	10	748	732	716	700	685	669	653
	20	747	738	728	718	709	699	690
June	1	747	742	738	734	729	725	721
	10	747	745	742	740	738	736	734
	20	747	745	744	743	741	740	739
July	1	747	744	741	739	736	733	731
	10	747	742	736	731	725	720	714
	20	747	737	727	717	707	696	686
August	1	748	730	712	694	676	658	640
	10	749	724	699	673	648	623	598
	20	750	716	681	647	612	578	544
September	1	752	705	658	612	565	519	472
	10	753	696	640	584	528	471	415
	20	754	687	619	552	485	418	350
October	1	755	676	597	517	438	359	280
	10	756	667	579	490	401	313	224
	20	757	659	560	462	363	264	166
November	1	758	649	540	431	322	213	104
	10	759	643	528	412	296	180	65
	20	760	638	516	395	273	151	29
December	1	760	634	508	381	255	128	
	10	761	632	503	375	246	118	
	20	761	631	502	373	244	114	

Interpolate as needed for date and latitude.

Table 2-7 Clear sky radiation correction term for elevation

Month	Day	Elevation, feet						
		1000	2000	3000	4000	5000	6000	7000
		R_{sc}^e (lang/d)						
January	1	2.8	5.6	8.3	11.1	13.9	16.7	19.5
	10	2.9	5.8	8.8	11.7	14.6	17.5	20.5
	20	3.2	6.3	9.5	12.6	15.8	18.9	22.1
February	1	3.5	7.1	10.6	14.2	17.7	21.2	24.8
	10	3.9	7.8	11.7	15.5	19.4	23.3	27.2
	20	4.3	8.6	13.0	17.3	21.6	25.9	30.2
March	1	4.7	9.5	14.2	19.0	23.7	28.5	33.2
	10	5.2	10.4	15.6	20.8	26.0	31.2	36.4
	20	5.7	11.4	17.1	22.9	28.6	34.3	40.0
April	1	6.3	12.7	19.0	25.3	31.6	38.0	44.3
	10	6.8	13.5	20.3	27.1	33.9	40.6	47.4
	20	7.2	14.5	21.7	28.9	36.2	43.4	50.7
May	1	7.7	15.4	23.1	30.8	38.5	46.2	53.9
	10	8.0	16.0	24.0	32.1	40.1	48.1	56.1
	20	8.3	16.6	24.9	33.2	41.5	49.9	58.2
June	1	8.6	17.1	25.7	34.2	42.8	51.3	59.9
	10	8.7	17.3	26.0	34.7	43.3	52.0	60.6
	20	8.7	17.4	26.1	34.8	43.5	52.2	60.9
July	1	8.6	17.3	25.9	34.5	43.2	51.8	60.5
	10	8.5	17.0	25.5	34.0	42.5	51.0	59.5
	20	8.3	16.6	24.8	33.1	41.4	49.7	58.0
August	1	7.9	15.8	23.7	31.7	39.6	47.5	55.4
	10	7.6	15.2	22.7	30.3	37.9	45.5	53.0
	20	7.1	14.3	21.4	28.6	35.7	42.9	50.0
September	1	6.6	13.2	19.7	26.3	32.9	39.5	46.0
	10	6.1	12.2	18.4	24.5	30.6	36.7	42.9
	20	5.6	11.2	16.8	22.4	28.0	33.7	39.3
October	1	5.0	10.1	15.1	20.2	25.2	30.3	35.3
	10	4.6	9.2	13.8	18.4	23.0	27.6	32.2
	20	4.1	8.3	12.4	16.6	20.7	24.8	29.0
November	1	3.6	7.3	10.9	14.6	18.2	21.9	25.5
	10	3.3	6.7	10.0	13.3	16.7	20.0	23.3
	20	3.1	6.1	9.2	12.2	15.3	18.3	21.4
December	1	2.8	5.7	8.5	11.3	14.2	17.0	19.8
	10	2.7	5.5	8.2	10.9	13.7	16.4	19.1
	20	2.7	5.4	8.1	10.8	13.5	16.2	18.9

Interpolate for unlisted elevations.

The atmospheric emittance depends on the amount of water vapor in the air. As the amount of water vapor increases, the emittance decreases. Wright (1982) described the emittance as:

$$\epsilon' = a_1 - 0.044\sqrt{e_d} \quad [2-33]$$

where:

- ϵ' = the net atmospheric emittance
- e_d = saturation vapor pressure at the mean dew point temperature (mb)
- a_1 = factor to account for the change of emissivity because of day length: [2-34]

$$a_1 = 0.26 + 0.1 \text{EXP} \left\{ - \left[0.0154(-170 + 0.986 \text{DOY}) \right]^2 \right\}$$

EXP = exponential function

Values for a_1 are summarized for various dates in table 2-8. Values of the emittance can be computed using equation 2-33 and are summarized for various conditions in table 2-8.

The product of σT_s^4 in equation 2-31 represents the amount of longwave radiation emitted by an ideal surface called a black body. Computed results are summarized in table 2-9. The process to compute the outgoing longwave radiation for a clear sky is illustrated in example 2-5.

Once these values are known, the net outgoing longwave radiation (R_b) can be computed using equation 2-28. This process is illustrated in example 2-6.

The net radiation can now be calculated based upon the data for the example site as illustrated in example 2-7.

Example 2-5 Outgoing longwave radiation R_{bo}

Given: The average maximum and minimum air temperatures for June 10 at the example site are 88 °F and 61 °F, respectively, with a dew point temperature of 57 °F.

Compute: The outgoing longwave radiation for a clear sky (R_{bo}) for June.

Solution: Use equation 2-11 to compute the saturated vapor pressure at the dew point temperature, $e_d = 15.9$ mb. From table 2-8 or equation 2-33 and 2-34, the atmospheric emittance (ϵ') is 0.18.

From table 2-9, the black body radiation (σT_s^4) is 910 lang/d.

Then:

$$R_{bo} = \epsilon' \sigma T_s^4 = 0.18 \times 910 \text{ lang / d} = 164 \text{ lang / d}$$

Example 2-6 Outgoing longwave radiation (R_b) for a clear sky

Compute: The net outgoing longwave radiation for the example site for June 10 where $R_s = 650$ lang/d.

Solution:

$$R_b = \left(a \frac{R_s}{R_{so}} + b \right) R_{bo}$$

From example 2-4, $R_{so} = 761$ lang/d

From example 2-5, $R_{bo} = 164$ lang/d

The ratio of $R_s/R_{so} = 0.85$

Thus $a = 1.126$ and $b = -0.07$.

Therefore, $R_b = (1.126 \times 0.85 - 0.07) 164$ lang/d

$$R_b = 145 \text{ lang/d}$$

Example 2-7 Net outgoing longwave radiation (R_n)

Compute: The net radiation for the example site on June 10.

Solution: From equation 2-24:

$$R_n = (1 - \alpha)R_s - R_b$$

Since the ratio of $R_s/R_{so} > 0.70$, use equations 2-25 through 2-27 to find the albedo.

June 10 is the 161st day of the year, so $DOY = 161$.

From equation 2-27, the solar declination $\theta_d = 22.9^\circ$.

The latitude at the site is $37^\circ 46'$ or 37.8° .

Using the solar declination and latitude, the solar altitude is given by:

$$\theta_m = \text{SIN}^{-1} \left[\text{SIN}(22.9) \times \text{SIN}(37.8) + \text{COS}(22.9) \text{COS}(37.8) \right] = 75^\circ$$

The albedo is then computed as:

$$\alpha = 0.108 + 0.000939 \times (75) + 0.257 \times \text{EXP} \left(\frac{-75}{57.3} \right)$$

$$\alpha = 0.25$$

From example 2-6, $R_b = 145$ lang/d, and $R_s = 650$ lang/d for the example site.

Thus, the net radiation (R_n) is:

$$R_n = (1 - 0.25) \times 650 - 145$$

$$R_n = 343 \text{ lang / d}$$

Table 2-8 Values of the a_1 parameter and the atmospheric emittance (ϵ')

Month	Day	a_1	----- Saturated vapor pressure at dew point temperature, mb -----							
			5	10	15	20	25	30	35	40
January	1	0.260	0.16	0.12	0.09	0.06	0.04	0.02	0.00	
	10	0.260	0.16	0.12	0.09	0.06	0.04	0.02	0.00	
	20	0.260	0.16	0.12	0.09	0.06	0.04	0.02	0.00	
February	1	0.261	0.16	0.12	0.09	0.06	0.04	0.02	0.00	
	10	0.261	0.16	0.12	0.09	0.06	0.04	0.02	0.00	
	20	0.262	0.16	0.12	0.09	0.07	0.04	0.02	0.00	
March	1	0.264	0.17	0.12	0.09	0.07	0.04	0.02	0.00	
	10	0.267	0.17	0.13	0.10	0.07	0.05	0.03	0.01	
	20	0.271	0.17	0.13	0.10	0.07	0.05	0.03	0.01	
April	1	0.277	0.18	0.14	0.11	0.08	0.06	0.04	0.02	0.00
	10	0.285	0.19	0.15	0.11	0.09	0.06	0.04	0.02	0.01
	20	0.294	0.20	0.16	0.12	0.10	0.07	0.05	0.03	0.02
May	1	0.308	0.21	0.17	0.14	0.11	0.09	0.07	0.05	0.03
	10	0.319	0.22	0.18	0.15	0.12	0.10	0.08	0.06	0.04
	20	0.332	0.23	0.19	0.16	0.14	0.11	0.09	0.07	0.05
June	1	0.345	0.25	0.21	0.17	0.15	0.13	0.10	0.08	0.07
	10	0.353	0.25	0.21	0.18	0.16	0.13	0.11	0.09	0.08
	20	0.359	0.26	0.22	0.19	0.16	0.14	0.12	0.10	0.08
July	1	0.360	0.26	0.22	0.19	0.16	0.14	0.12	0.10	0.08
	10	0.356	0.26	0.22	0.19	0.16	0.14	0.12	0.10	0.08
	20	0.348	0.25	0.21	0.18	0.15	0.13	0.11	0.09	0.07
August	1	0.336	0.24	0.20	0.17	0.14	0.12	0.10	0.08	0.06
	10	0.324	0.23	0.19	0.15	0.13	0.10	0.08	0.06	0.05
	20	0.311	0.21	0.17	0.14	0.11	0.09	0.07	0.05	0.03
September	1	0.298	0.20	0.16	0.13	0.10	0.08	0.06	0.04	0.02
	10	0.288	0.19	0.15	0.12	0.09	0.07	0.05	0.03	0.01
	20	0.280	0.18	0.14	0.11	0.08	0.06	0.04	0.02	0.00
October	1	0.272	0.17	0.13	0.10	0.08	0.05	0.03	0.01	
	10	0.268	0.17	0.13	0.10	0.07	0.05	0.03	0.01	
	20	0.265	0.17	0.13	0.09	0.07	0.04	0.02	0.00	
November	1	0.263	0.16	0.12	0.09	0.07	0.04	0.02	0.00	
	10	0.262	0.16	0.12	0.09	0.06	0.04	0.02	0.00	
	20	0.261	0.16	0.12	0.09	0.06	0.04	0.02	0.00	
December	1	0.260	0.16	0.12	0.09	0.06	0.04	0.02	0.00	
	10	0.260	0.16	0.12	0.09	0.06	0.04	0.02	0.00	
	20	0.260	0.16	0.12	0.09	0.06	0.04	0.02	0.00	

Table 2-9 Emittance of longwave radiation by a perfect black body (σT_s^4), lang/d

Max. temp. (°F)	Minimum daily temperature, °F																			
	0	5	10	15	20	25	30	35	40	45	50	55	60	65	70	75	80	85	90	95
10	520	532	543																	
15	532	543	555	566																
20	544	555	567	578	591															
25	557	568	579	591	603	616														
30	570	581	592	604	616	629	641													
35	583	594	605	617	629	642	655	668												
40	597	608	619	631	643	656	668	682	695											
45	611	622	633	645	657	670	683	696	710	724										
50	625	636	648	660	672	684	697	710	724	738	753									
55	640	651	663	675	687	699	712	725	739	753	768	783								
60	656	667	678	690	702	715	728	741	755	769	783	798	814							
65	672	683	694	706	718	731	743	757	770	785	799	814	830	845						
70	688	699	710	722	734	747	760	773	787	801	815	830	846	862	878					
75	705	716	727	739	751	764	777	790	804	818	832	847	863	879	895	912				
80	722	733	745	756	768	781	794	807	821	835	850	865	880	896	912	929	946			
85	740	751	762	774	786	799	812	825	839	853	867	882	898	914	930	947	964	982		
90	758	769	781	792	805	817	830	843	857	871	886	901	916	932	948	965	982	1000	1018	
95	777	788	799	811	823	836	849	862	876	890	904	919	935	951	967	984	1001	1019	1037	1056
100	796	807	819	830	843	855	868	881	895	909	924	939	954	970	986	1003	1020	1038	1057	1075
105	816	827	839	850	862	875	888	901	915	929	944	959	974	990	1006	1023	1040	1058	1076	1095
110	837	848	859	871	883	895	908	921	935	949	964	979	994	1010	1027	1043	1061	1078	1097	1115
115	857	868	880	892	904	916	929	942	956	970	985	1000	1015	1031	1047	1064	1082	1099	1118	1136
120	879	890	901	913	925	938	951	964	978	992	1006	1021	1037	1053	1069	1086	1103	1121	1139	1158

(f) Estimating solar radiation

In some locations, solar radiation is not measured, but can be estimated based upon extraterrestrial radiation (R_a). Extraterrestrial radiation represents the radiation intensity above the Earth's atmosphere and is unaffected by cloud cover. Thus, extraterrestrial radiation depends only on the time of year and the latitude (fig. 2-9). Values for the extraterrestrial radiation are tabulated for various dates and latitudes in table 2-10.

Doorenbos and Pruitt (1977) recommended using the following expression to relate solar to extraterrestrial radiation:

$$R_s = \left[0.25 + 0.50 \frac{n}{N} \right] R_a \quad [2-35]$$

where:

$\frac{n}{N}$ = the ratio between actual bright sunshine hours (n) and maximum possible sunshine hours (N) per day.

Figure 2-9 Extraterrestrial radiation as a function of time for various latitudes

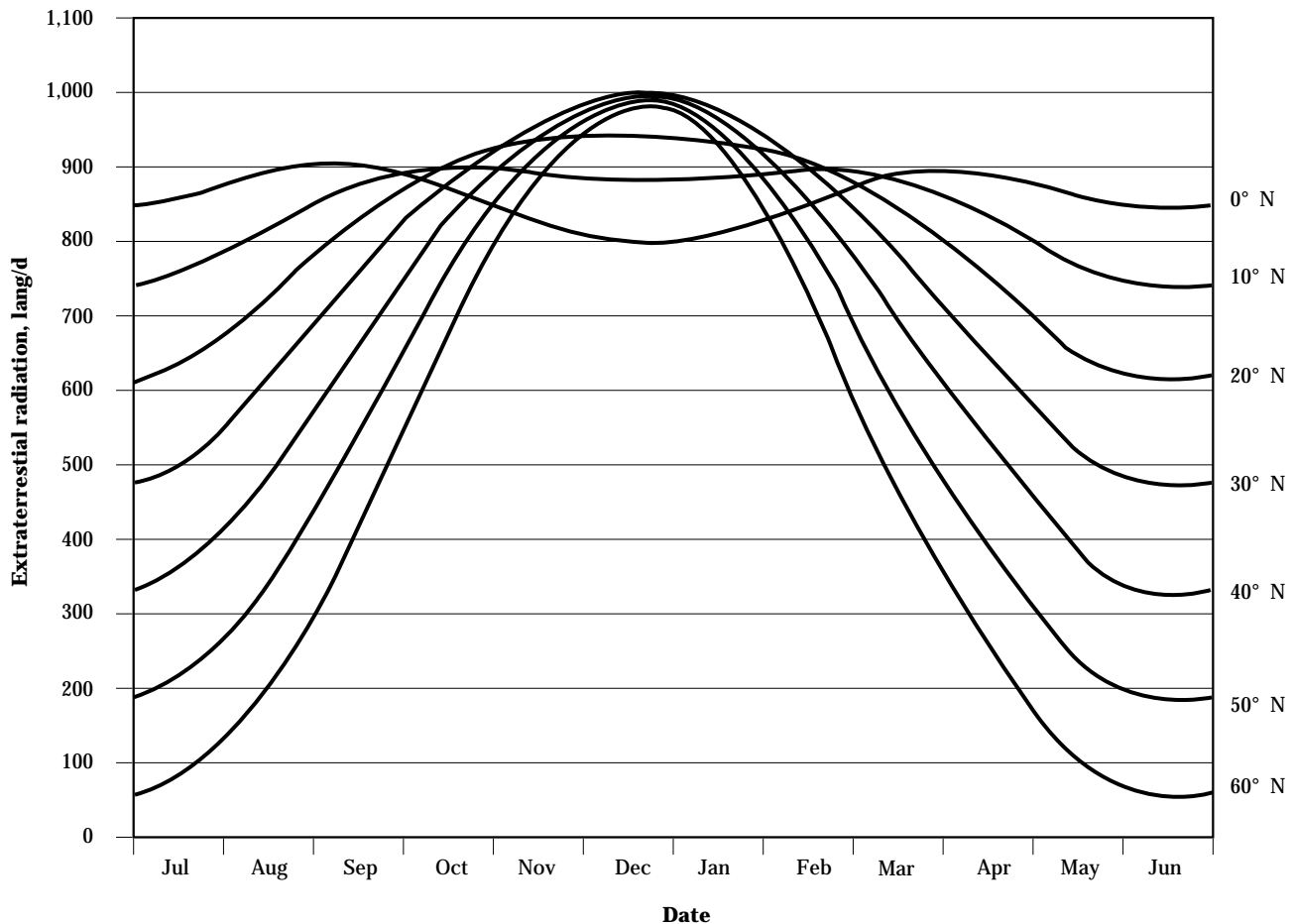

Table 2-10 Extraterrestrial radiation (R_a), lang/d

Date	Degrees North Latitude						
	0	10	20	30	40	50	60
January 1	854	744	617	477	330	184	55
January 10	859	754	629	491	345	199	67
January 20	868	769	650	516	372	226	89
February 1	880	793	683	557	418	272	130
February 10	890	812	713	594	459	316	171
February 20	898	835	748	639	512	373	227
March 1	904	856	783	687	570	438	294
March 10	906	873	814	730	625	501	362
March 20	904	888	846	778	686	573	443
April 1	895	900	878	830	757	661	545
April 10	884	905	898	865	806	724	622
April 20	870	906	916	899	856	790	705
May 1	852	903	929	929	904	855	789
May 10	837	899	936	948	936	901	850
May 20	822	893	941	965	964	942	907
June 1	808	887	944	977	987	978	957
June 10	800	884	945	982	997	993	980
June 20	797	882	944	984	1001	998	988
July 1	799	882	942	980	995	990	976
July 10	805	884	940	973	983	973	952
July 20	815	887	936	961	962	942	909
August 1	831	892	929	940	927	892	841
August 10	845	895	920	919	894	845	779
August 20	860	897	907	891	850	786	702
September 1	877	894	885	850	790	706	603
September 10	886	889	865	814	740	643	526
September 20	893	879	837	771	681	570	442
October 1	896	862	803	720	615	491	354
October 10	894	846	773	677	561	430	288
October 20	889	826	738	630	505	367	222
November 1	880	800	698	578	443	300	157
November 10	872	782	671	544	404	259	119
November 20	863	764	645	512	369	223	87
December 1	855	749	625	487	341	196	65
December 10	851	742	614	474	328	182	54
December 20	851	739	611	470	323	178	50
December 31	854	744	617	477	330	184	55

The ratio n/N can be estimated and is available for many locations for average conditions (USDC 1977). Average ratios can be very useful in designing irrigation systems, but are more difficult to determine for daily calculations for irrigation scheduling. The solar radiation should be measured directly for scheduling or other short-term estimates. Example 2-8 illustrates the estimation of R_s .

A flow chart (fig. 2-10) has been prepared to assist with computing radiation terms. This chart assumes that either R_s or the ratio n/N is known.

(g) Soil heat flux

The soil is capable of absorbing, emitting, and storing energy. Some energy available for evapotranspiration could be used to heat the soil. Conversely, if the soil is warmer than the crop, the soil could provide some energy for evapotranspiration. The amount of energy entering or leaving the soil, called the soil heat flux, is denoted by the symbol G . If the algebraic value of G is positive, the soil is absorbing energy. If G is less than zero, the soil is providing energy for evapotranspiration.

The average daily amount of soil heat flux over a 10 to 30 day period is usually small. The value of G generally becomes more important for daily calculations and for long-term estimates. Wright (1982) presented the following method of computing the daily soil heat flux:

$$G = c_s(T_a - T_p) \quad [2-36]$$

where:

- G = soil heat flux (lang/d)
- c_s = an empirical specific heat coefficient for the soil (lang/°F/d)
- T_a = average air temperature for the current day, (°F)
- T_p = mean air temperature for the preceding three days (°F)

Wright (1982) used a value of 5 langleys per degree Fahrenheit per day for c_s for an alfalfa crop at Kimberly, Idaho. The value of c_s varies for grass grown on other soils and in other locations. Unfortunately, other values of c_s are not readily available, and the value from Wright should be used as an initial approximation. Computation of the soil heat flux with this method is illustrated in example 2-9.

For monthly or longer ET estimates, Jensen, et al. (1990) presented a method that assumes that the soil temperature at a depth of 6.6 feet is approximately the average temperature for the previous time period. Their method is given by:

$$G_i = 55.7 \frac{(T_{i+1} - T_{i-1})}{\Delta t} \quad [2-37]$$

where:

- G_i = soil heat flux in lang/d for period i
- T = average air temperature in °F in time period $i+1$ and $i-1$
- Δt = time interval for period i in days

Example 2-8 R_s estimate

Estimate: The average amount of solar radiation in June for the example site.

Solution: The ratio of (n/N) for June is 0.74 (from table 2-3)

For the example site, the extraterrestrial radiation is 994 lang/d for June 10 (from table 2-10).

The solar radiation would be about:

$$R_s = [0.25 + (0.50 \times 0.74)]994 = 616 \text{ lang / d}$$

From this point, the net radiation could be estimated.

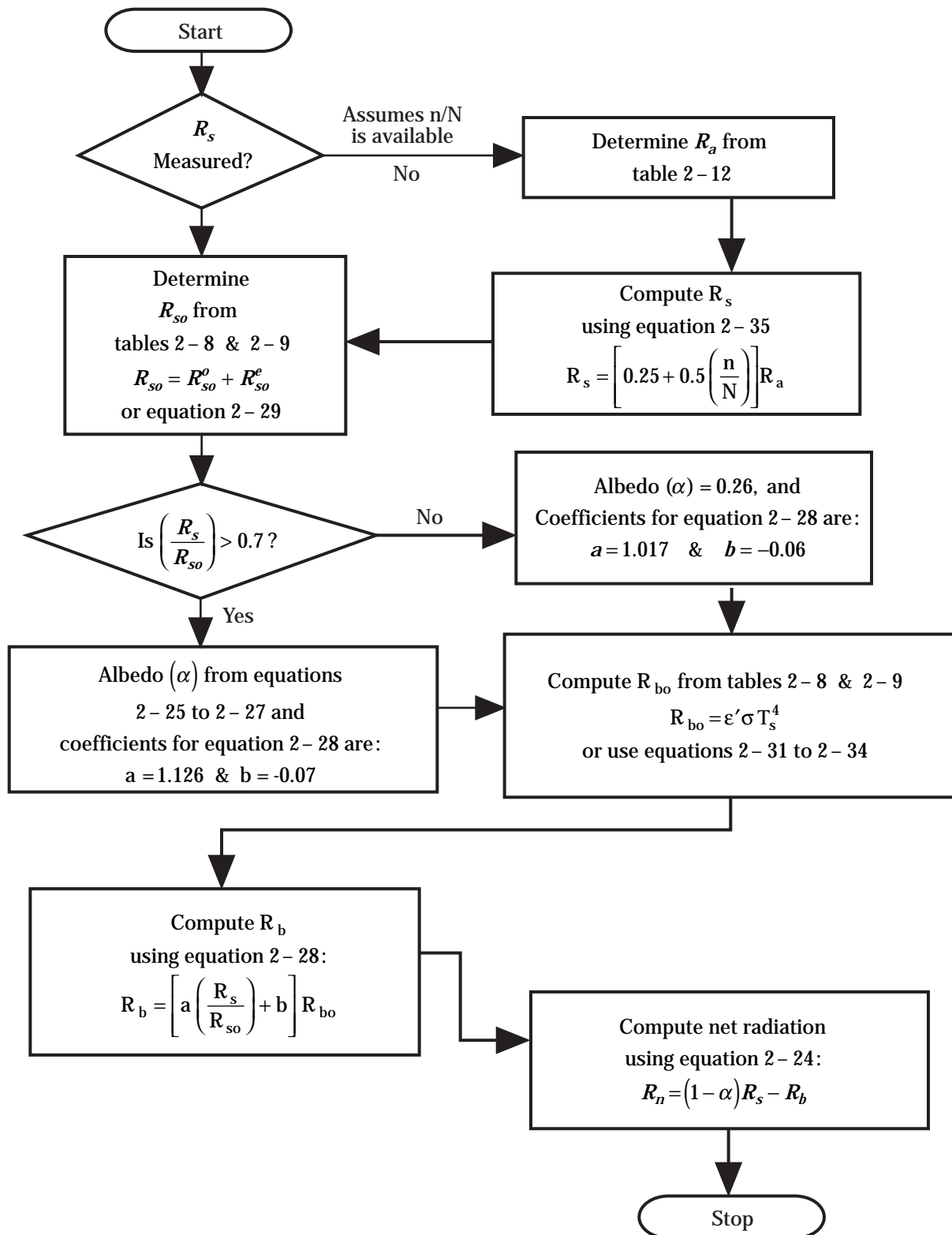
Figure 2-10 Flow chart for computing net radiation

It should be emphasized that equation 2-37 is not applicable for daily calculations. Example 2-10 illustrates calculation for the monthly soil heat flux.

In summary, to calculate the soil heat flux, equation 2-36 should be used for daily calculations. For time periods from 10 to 30 days, the soil heat flux can generally be ignored. For monthly or longer periods, equation 2-37 should be used.

Example 2-9 Daily soil heat flux

Compute: The soil heat flux for June 10 for the following air temperature data:

Date	Daily air temperatures, °F	
	Maximum	Minimum
June 7	80	60
June 8	85	62
June 9	72	52
June 10	74	58

Solution: Compute the average temperature as the mean of the daily maximum and minimum temperature:

Date	Average temperature, °F
June 7	70
June 8	73.5
June 9	62
June 10	66

From these data,

$$T_a = 66^\circ\text{F and}$$

$$T_p = \frac{(70 + 73.5 + 62)}{3}$$

$$T_p = 68.5^\circ\text{F}$$

Then the soil heat flux is:

$$G = c_s(T_a - T_p)$$

$$G = 5 \text{ lang / } ^\circ\text{F / d}(66 - 68.5)^\circ\text{F}$$

$$G = -13 \text{ lang / d}$$

Since the average temperature has been warmer than today, the soil is warm and provides energy to evaporate water.

(h) Weather stations

Evapotranspiration predictions are only as accurate and representative as the climatic data. The siting, maintenance, and management of the weather station are critical. Procedures should be developed to ensure that the highest quality of data is maintained. A calibration and maintenance schedule should be maintained to ensure quality and to provide records to increase user confidence in the climatic data.

Climatic data must sometimes be used from stations located some distance away from the area under study. This is permissible when weather is similar over large areas. Where the climate changes rapidly over short distances, the user must be very careful to ensure that the available climatic data is representative. In some cases, adjustment of climatic data is necessary if the weather station does not represent the irrigated area. An example is data from an airport. The airport is generally surrounded by an urban area that has a different climate than an irrigated area.

Other instances of rapid climatic changes are arid areas inland from large lakes, interior mountain valleys, and areas where an air mass is forced upward by mountain ranges. When the weather changes quickly with distance from a land or water surface, evapotranspiration may change markedly (fig. 2-11).

Studies have shown that air over irrigated areas may be 4 to 10 °F lower than over adjacent nonirrigated areas (Allen, et al. 1983 and Burman, et al. 1975). Higher relative humidities and smaller vapor pressure deficits were also measured. The differences in air temperature between irrigated and nonirrigated areas are related to the extensiveness and aridity of the surrounding area and the size of the irrigated area.

Climatic data used to design irrigation projects are often collected before irrigation development. The weather stations used to supply these data are often located in rainfed or uncultivated areas, or even at airports. Irrigated fields have different micro-climates than these stations, and ET may not be equal to predicted values when using these data. This problem is most severe in arid, windy climates.

Example 2-10 Monthly soil heat flux

Calculate: The expected soil heat flux at the example site for June.

Solution: The monthly temperature data are:

Month	Average air temperature, °F
(i-1) May	64.0
(i) June	74.5
(i+1) July	80.0

The time from the middle of May until the middle of July is about 60 days. Thus,

$$G = 55.7 \frac{(80 - 64)}{60} = 15 \text{ lang / d}$$

Since $G > 0$, the soil is heated during June, which requires energy that could have been used for ET.

In arid and semi-arid climates, irrigated fields surrounded by dry fallow areas are subject to advection. Air masses moving into the irrigated area give up heat as they move over the area. This results in a *clothesline effect* at the upwind edge and an *oasis effect* inside the irrigated field. With warm, dry winds, appreciably higher evapotranspiration rates can be expected at the upwind edge of the field. With distance, the air becomes cooler and more humid. Thus, the *clothesline effect* becomes negligible with distance from the border. These effects may extend between 300 and 1,200 feet in hot, dry climates where the wind speed is more than 10 miles per hour. Because of the *clothesline effect*, results of irrigation trials from small fields located in dry surroundings may indicate up to double the evapotranspiration rate of large areas.

Because of the *oasis effect*, evapotranspiration will be higher in fields surrounded by dry fallow land than in fields surrounded by extensive vegetated area. However, air temperature is generally lower and humidity higher inside the large irrigated area than that outside the area. Where evapotranspiration is predicted using climatic data collected outside or before irrigation development in semi-arid and arid areas, evapotranspiration could be overpredicted by 5 to 15 percent for fields of 10 to 50 acres and 10 to 25 percent for large projects when nearly all the area is later planted to irrigated crops. The main cause of overprediction is the distribution of fallow and cropped fields. The air above a fallow field is heated before moving to the next field. This is shown in figure 2-12 for pan evaporation across irrigated cotton and fallow fields.

Figure 2-11 Changes in ET_0 with distance from the ocean for three locations in California (adapted from Doorenbos and Pruitt 1977)

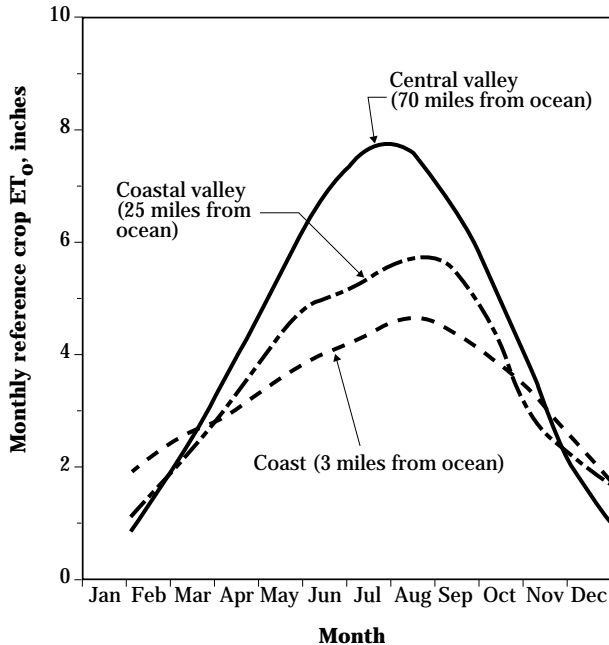

Where climatic data collected from another region or before irrigation development are used, a correction factor is needed to obtain evapotranspiration data for irrigated fields of different sizes that are surrounded by dry fallow and in arid, hot areas that have moderate wind. Doorenbos and Pruitt (1977) presented the adjustment factor shown in figure 2-13. They caution that the correction factor should not be used for very small fields (<0.1 acres) because the adjustment could be very large and crop damage could result if it was incorrect.

Figure 2-12 Effect of advection on the evaporation rate from an evaporation pan (adapted from Doorenbos and Pruitt 1977)

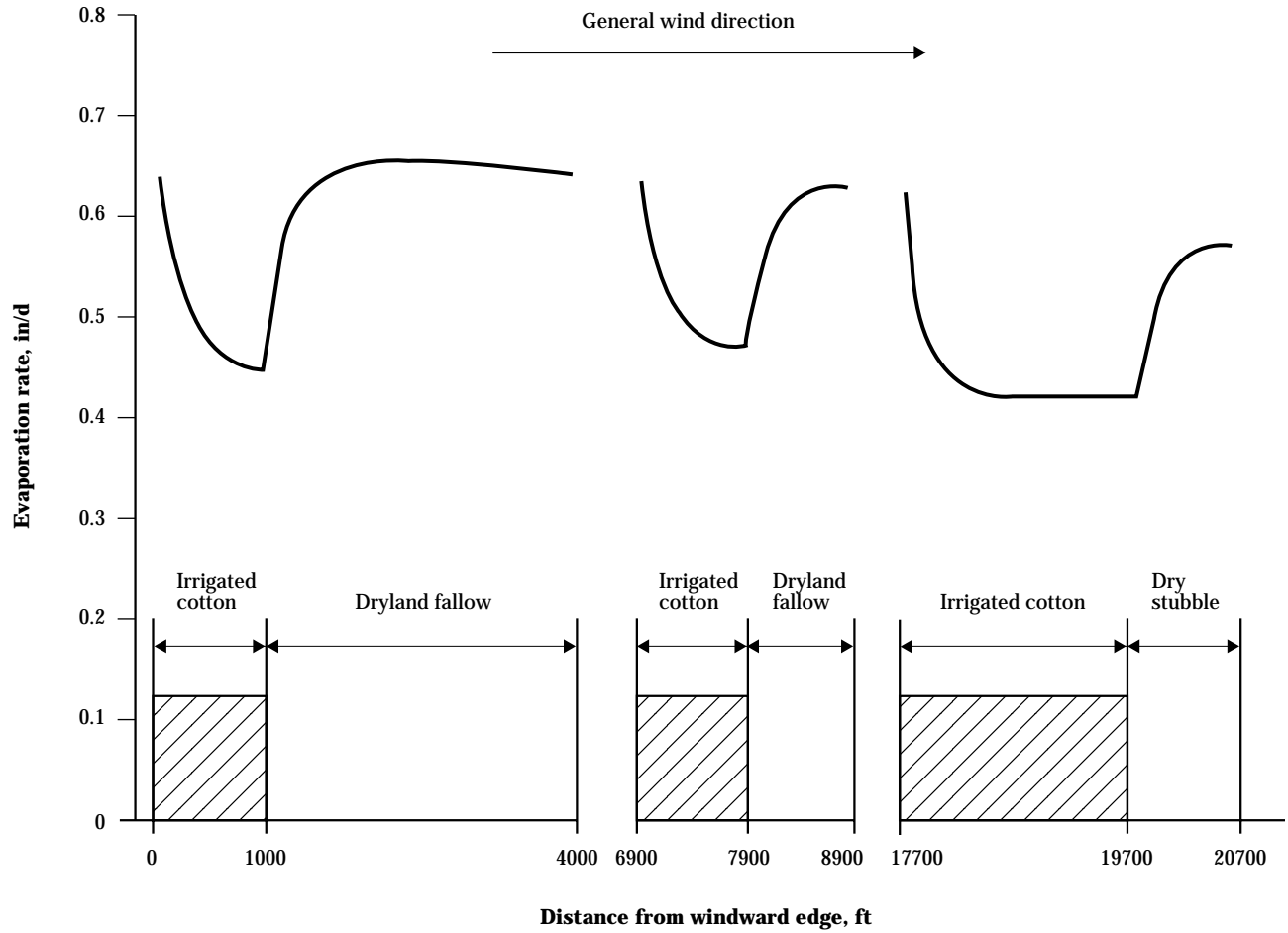
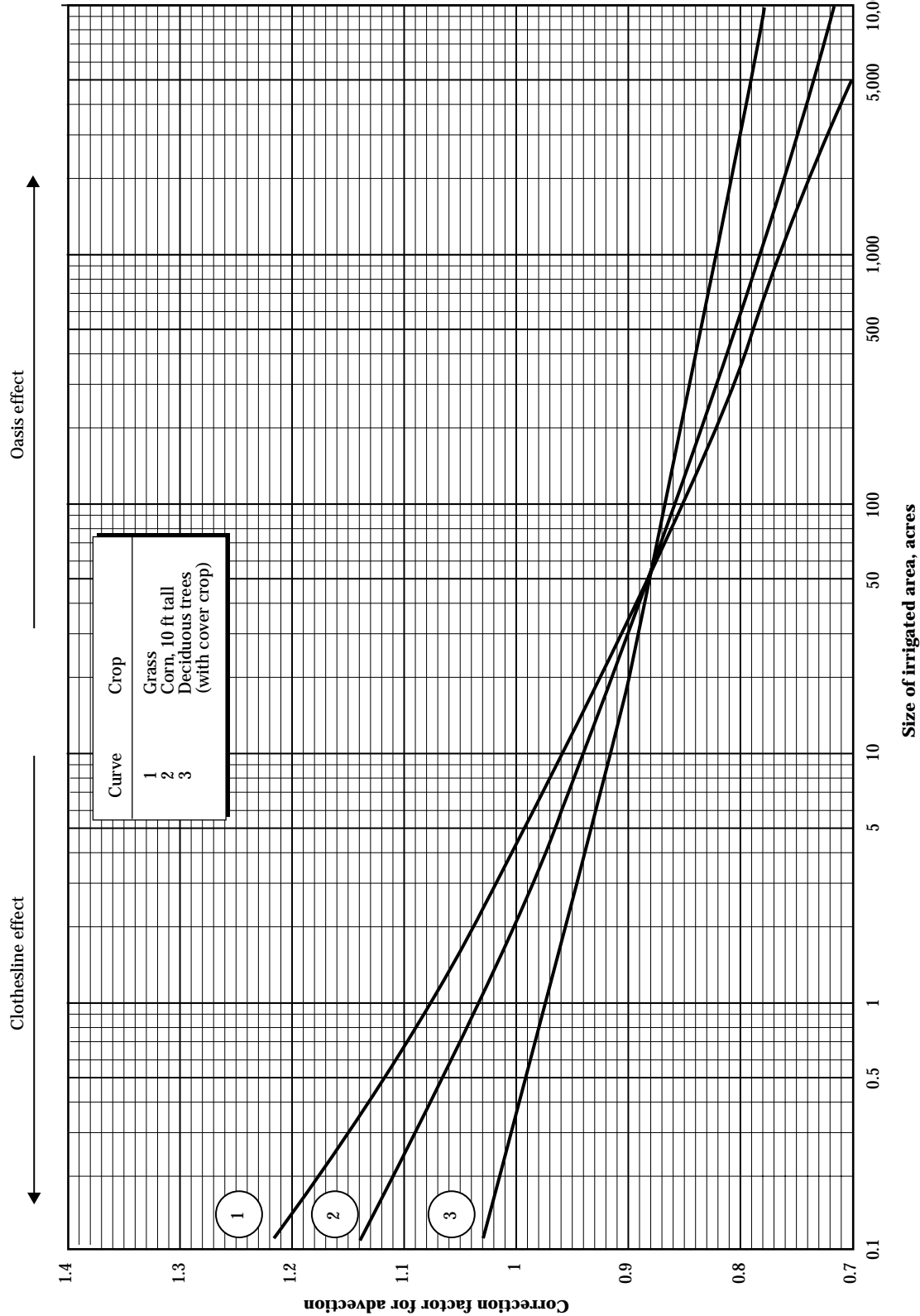

Figure 2-13 Correction factor for evapotranspiration because of advection using data outside or before irrigation development for different sizes of irrigated areas under arid and moderate wind conditions (Doorenbos and Pruitt 1977)



623.0203 Reference crop evapotranspiration

In this handbook, the reference crop is considered to be a clipped, well watered and healthy grass that is 3 to 6 inches tall. Calculation procedures assume that salinity does not affect the rate of evapotranspiration. The reference crop evapotranspiration is denoted ET_o and is generally expressed as a depth of water use per day (in/d). The ET_o represents a hypothetical crop for some locations as it may not be possible to grow such a grass throughout a season in all areas. However, ET_o can be computed as a reference for estimating actual crop evapotranspiration (ET_c) in such areas.

Various methods have been developed to compute reference crop evapotranspiration. Four methods are presented in this handbook. The most accurate, and complex, method is the Penman-Monteith method as presented by Allen (1986). Radiation and advection are both considered in the method. The Penman-Monteith method requires climatic data for air temperature and humidity, wind speed, and solar radiation. If accurate climatic data are available the method can be used for daily computation of ET_o values.

The second method is the radiation method as presented by Doorenbos and Pruitt (1977). This method requires solar radiation and air temperature data to compute evapotranspiration for the grass reference crop. Where accurate data are available, the radiation method can be confidently applied to compute average ET_o values for 5-day periods. The radiation method is not as dependable as the Penman-Monteith method when computing ET_o for a specific day.

The third method is the temperature method based on the FAO-Blaney-Criddle method developed by Doorenbos and Pruitt (1977). This method is based on actual air temperature data and long-term average conditions for relative humidity, solar radiation, and wind velocity. It has been shown to provide accurate estimates of average ET_o for 5-day periods. Like the radiation method, the temperature method is less precise than the Penman-Monteith method for estimating ET_o for only 1 day.

The final method relates ET_o to the rate of evaporation from a Class A evaporation pan. The evaporation pan method is based on procedures by Doorenbos and Pruitt (1977) to adjust the method to local humidity, wind, and fetch conditions. Because of the energy storage by evaporation pans, this method is recommended for measuring the average ET_o over 10-day periods or longer. Details on each method are presented later in this section. Details of the SCS Blaney-Criddle method as in Technical Release Number 21 are given in the appendix.

(a) Selection and application of reference crop ET method

Selection of the proper method of computing reference crop evapotranspiration depends on:

- Type, accuracy, and duration of available climatic data.
- Natural pattern of evapotranspiration during the year.
- Intended use of the evapotranspiration estimates.

The type, quality, and length of record of climatic data greatly affect the selection of an ET_o method. Some irrigation management applications require real-time data while design and water right considerations require an assessment of historical water use patterns. Thus, the length of time that various types of data are available may dictate the type of method to use in estimating ET_o . In many locations air temperature has been recorded for long periods. Wind speed, relative humidity, and solar radiation data are less available and are more difficult to measure, causing these data to be less reliable. Thus, some locations may require use of the temperature based ET_o method while at other locations, other methods would be more appropriate. The available climatic data should be compiled and evaluated before beginning any computation. The usable methods can be identified once data quality has been determined.

The natural pattern of crop water use can affect the selection of an ET_o method. Crop evapotranspiration varies from day to day because of fluctuating climatic conditions and plant growth. The variation can be large in some climates. The daily crop evapotranspiration can be averaged over a period, such as 5 days.

This provides the average daily crop evapotranspiration for that period. The average daily crop evapotranspiration for each 5-day period of the summer could be computed for a series of years, producing a set of 5-day average daily crop evapotranspiration values. Of course, the 5-day average daily crop evapotranspiration data will vary among the sets.

An example of the variation of average daily evapotranspiration for ryegrass for different lengths of the averaging period is given in figure 2-14. The probability shown in this figure represents the chances of the average daily evapotranspiration being less than a given amount of evapotranspiration. For example, the average daily evapotranspiration for a 5-day period will be less than 0.225 inches per day for 99 percent of the values in the set of 5-day averages. If we assume that the future will resemble the past, we can expect the 5-day average evapotranspiration for ryegrass at this location to be less than 0.225 inches per day 99 percent of the time in the future.

Figure 2-14 Variation of the average daily ET_c as affected by the length of the averaging period (adapted from Doorenbos and Pruitt 1977)

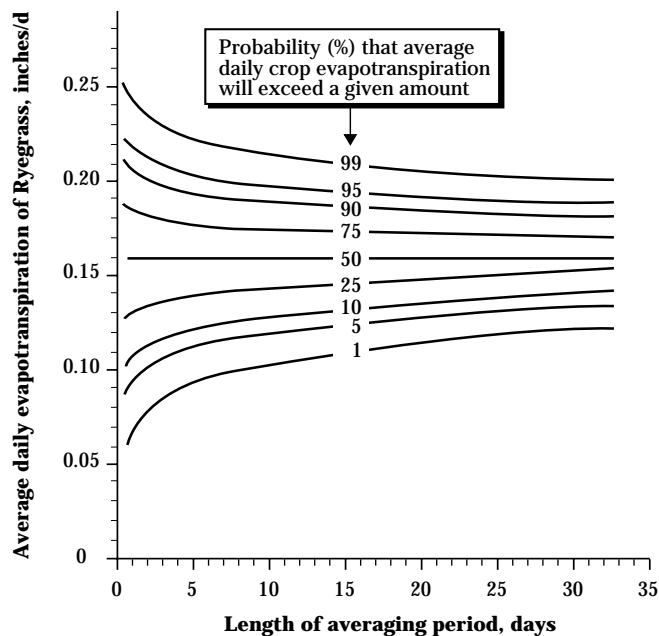

Averaging dampens out the fluctuation of daily evapotranspiration data and decreases the range of average daily evapotranspiration. Therefore, the range of values for the 5-day average daily evapotranspiration is smaller than that of the daily values. This is illustrated in figure 2-14. Consider the 5-day average daily evapotranspiration for the 1 percent and 99 percent probabilities. The 5-day average daily evapotranspiration is smaller than 0.225 inches per day 99 percent of the time and smaller than 0.090 inches per day 1 percent of the time. Therefore, the 5-day average is between 0.09 and 0.225 inches per day 98 percent of the time. Compare this to when the data are averaged over 10 days. The 10-day average is between 0.10 and 0.215 inches per day 98 percent of the time.

Errors in daily estimates of reference crop evapotranspiration also tend to balance out when averaging over a period. On some days, the errors associated with either the climatic data or with the prediction method cause ET_o estimates to be excessive. On other days the method might underpredict ET_o . These errors compensate during the period, thus the accuracy of the ET_o estimate generally improves with longer computational periods (Jensen and Wright 1978).

The combined processes of less natural variation in average evapotranspiration for long periods and the error compensation within a period for ET_o predictions cause the magnitude of potential errors in ET_o estimates to decrease with the length of the computation period. Thus, less precise ET_o methods may provide adequate accuracy for long-term estimates. However, complex equations are required for short-term (daily) estimates.

Studies have shown that the Penman-Monteith method is more reliable for any length period than methods that use less climatic data (Jensen, et al. 1990). The method works well for daily calculations and for estimating monthly or seasonal water needs. If adequate data are available or can be estimated, the Penman-Monteith equation should be considered.

The radiation method and the temperature (FAO Blaney-Cridde) method are less precise than the Penman-Monteith method. These methods are acceptable for predicting the average daily water use for a period of days. However, they can produce significant errors for an individual day. Thus, these methods are recommended for calculating average ET_o for periods of 5 days or more.

The evaporation pan method is less reliable for short-term estimates than other ET_o methods and is recommended for periods of 10 days or longer. Evaporation pans can be accurate if well maintained and properly located. If the pan has a history of proper use, 10-day periods can be used. Poorly maintained pans and inappropriate siting can lead to severely biased data. If little previous history is available for a pan, caution should be exercised even for computing ET_o for longer periods.

The purpose for computing ET_o may determine the calculation method. Three examples will illustrate the variation in ET_o needs. Irrigation scheduling requires local real-time data. Irrigation system design considers a historical record to evaluate the expected maximum capacity for water supply and delivery systems. Reservoir design or water right determination may only require monthly water use estimates.

Daily ET_o estimates are not necessary for some irrigation scheduling applications. If a field is irrigated every 10 days, scheduling using the radiation or temperature based method, or an evaporation pan, may produce essentially the same schedule as that using the Penman-Monteith method. If high-value, shallow-rooted crops are grown on coarse textured soils, daily ET_o estimates may be necessary for accurate scheduling. In such cases the Penman-Monteith method would be best suited.

The selection of an ET_o method for designing an irrigation system depends on the required irrigation frequency. If crops are irrigated frequently because of a shallow root zone, coarse textured soils, or maintenance of large soil-water depletions, the required water supply rate will be larger than that for infrequent irrigation. Results in figure 2-14 illustrate this concept. To design a system you might want to meet the average daily evapotranspiration at least 90 percent of the time. If you irrigated daily, the ET_o for

design would be 0.21 inches per day in figure 2-14. The design ET_o drops to 0.195 inches per day for a 5-day irrigation frequency and to 0.190 inches per day for a 10-day period (fig. 2-14). The Penman-Monteith method is needed to adequately design for the daily irrigation frequency. Either the radiation method, the temperature method, or the Penman-Monteith method will suffice for the 5- or 10-day irrigation frequency. For design, climatic data must be available for a number of years to develop the probabilities as shown in figure 2-14. A less precise ET_o method with a longer history may be preferable to a precise method where a limited length of climatic data are available.

To design and operate a reservoir, or to establish water rights, the short-term estimate of ET_o is less valuable than the monthly or annual water use pattern. Often these uses require consideration of several crops and numerous fields where exact information is not available for each parcel. Thus, average ET_o values for biweekly, monthly, or annual periods may be adequate. For these applications, all the ET_o methods are acceptable, and the quality of the available climatic or evaporation pan data may be the deciding factor.

(b) Penman-Monteith method

Jensen, et al. (1990) compared 20 methods of computing ET_o for arid and humid locations. They found that the Penman-Monteith method as modified by Allen (1986) was the most accurate for either environment. Because of its accuracy, the Penman-Monteith method is recommended when air temperature, relative humidity, wind speed, and solar radiation data are available or can be reliably estimated. The method can also be adjusted to the physical features of the local weather station.

The Penman-Monteith method is given in equation 2-38.

$$ET_o = \left(\frac{1}{\lambda} \right) \left[\left(\frac{\Delta}{\Delta + \gamma^*} \right) (R_n - G) + \left(\frac{\gamma}{\Delta + \gamma^*} \right) \left(0.622 \frac{K_1 \lambda \rho}{BP} \right) \frac{(e_z^o - e_z)}{r_a} \right] \quad [2-38]$$

where:

- ET_o = the evapotranspiration rate for a grass reference crop (in/d)
- λ = heat of vaporization of water (lang/in) (equation 2-19)
- R_n = net radiation (lang/d)
- G = soil heat flux (lang/d)
- Δ = slope of the vapor pressure curve (mb/°F) (calculated by equation 2-16)
- γ = psychrometric constant (mb/°F) (calculated by equation 2-18),
- ρ = density of air (lb/ft³)
- BP = mean barometric pressure (mb)
- e_z^o = average saturated vapor pressure (mb) (calculated by equation 2-14)
- e_z = actual vapor pressure (mb) (calculated by equation 2-15)

$$\gamma^* = \gamma \left(1 + \frac{r_c}{r_a} \right) \quad (2-39)$$

where:

- r_c = surface resistance to vapor transport (d/mi)
- r_a = aerodynamic resistance to sensible heat and vapor transfer (d/mi)

The variables used to describe the aerodynamic resistance (r_a) are illustrated in figure 2-15. The aerodynamic resistance in units of days per mile is given by:

$$r_a = \frac{\text{LN} \left[\frac{(Z_w - d)}{Z_{om}} \right] \times \text{LN} \left[\frac{(Z_p - d)}{Z_{ov}} \right]}{0.168 U_z} \quad [2-40]$$

where:

- LN = natural logarithm function
- Z_w = the height of wind speed measurement (ft)
- Z_p = the height of the humidity (psychrometer) and temperature measurements (ft)
- U_z = the daily wind run at height Z_w (mi/d)
- d = the displacement height for the crop (ft)
- Z_{om} = the roughness length of momentum transfer (ft)
- Z_{ov} = the roughness length of vapor transfer (ft)

The value of $(0.622 K_1 \lambda \rho / BP)$ has units of langleys per mile per millibar and depends on the air temperature:

$$0.622 K_1 \frac{\lambda \rho}{BP} = (82 - 0.186 T) \quad [2-41]$$

where:

- K_1 = the dimension coefficient to ensure both terms have the same units
- T = the air temperature (°F)

Values for $(0.622 K_1 \lambda \rho / BP)$, Δ , λ , and γ as a function of temperature are listed in table 2-11.

Figure 2-15 Definition sketch for variables used to define the aerodynamic resistance

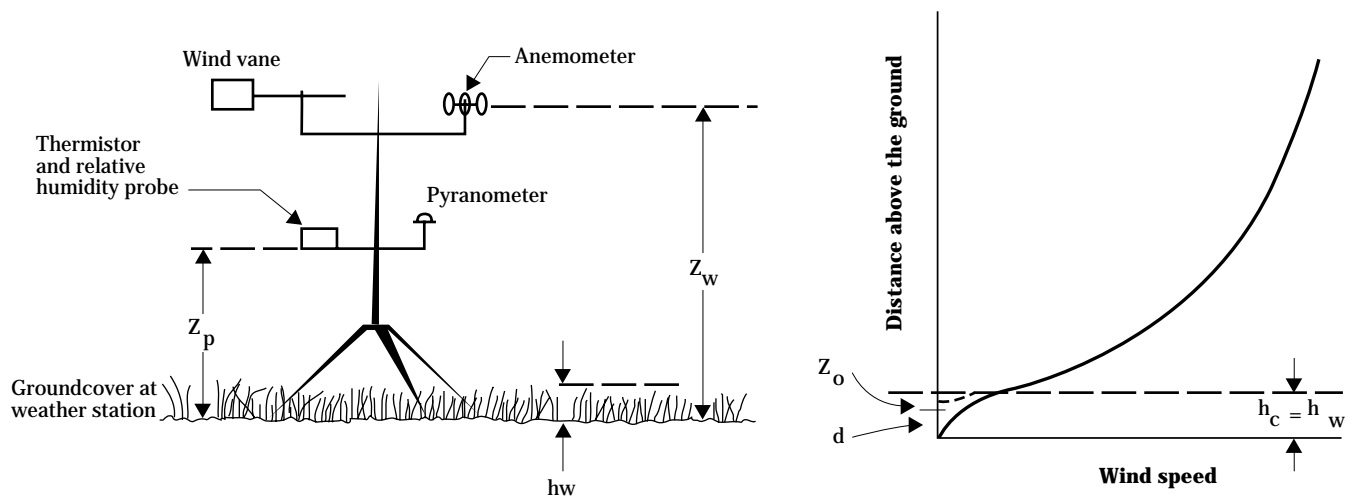

Table 2-11 Selected air properties for varying temperatures and elevations

Air temp (°F)	C_1 ^{1/}	Δ (mb/°F)	λ (lang/in)	----- Values of γ (mb/°F) for elevations (ft) of -----							
				0	1000	2000	3000	4000	5000	6000	7000
32	76.0	0.247	1518	0.363	0.350	0.338	0.326	0.314	0.302	0.291	0.280
34	75.7	0.265	1516	0.364	0.351	0.338	0.326	0.314	0.303	0.292	0.281
36	75.3	0.284	1514	0.364	0.351	0.339	0.326	0.314	0.303	0.292	0.281
38	74.9	0.305	1513	0.364	0.351	0.339	0.327	0.315	0.303	0.292	0.281
40	74.6	0.327	1511	0.365	0.352	0.339	0.327	0.315	0.304	0.292	0.282
42	74.2	0.350	1510	0.365	0.352	0.340	0.327	0.315	0.304	0.293	0.282
44	73.8	0.374	1508	0.366	0.353	0.340	0.328	0.316	0.304	0.293	0.282
46	73.4	0.400	1506	0.366	0.353	0.340	0.328	0.316	0.305	0.293	0.283
48	73.1	0.427	1505	0.366	0.353	0.341	0.328	0.316	0.305	0.294	0.283
50	72.7	0.456	1503	0.367	0.354	0.341	0.329	0.317	0.305	0.294	0.283
52	72.3	0.487	1502	0.367	0.354	0.341	0.329	0.317	0.306	0.294	0.283
54	72.0	0.519	1500	0.368	0.354	0.342	0.329	0.317	0.306	0.295	0.284
56	71.6	0.553	1498	0.368	0.355	0.342	0.330	0.318	0.306	0.295	0.284
58	71.2	0.590	1497	0.368	0.355	0.342	0.330	0.318	0.307	0.295	0.284
60	70.8	0.628	1495	0.369	0.356	0.343	0.330	0.318	0.307	0.296	0.285
62	70.5	0.668	1494	0.369	0.356	0.343	0.331	0.319	0.307	0.296	0.285
64	70.1	0.710	1492	0.369	0.356	0.344	0.331	0.319	0.308	0.296	0.285
66	69.7	0.755	1490	0.370	0.357	0.344	0.332	0.320	0.308	0.297	0.286
68	69.4	0.802	1489	0.370	0.357	0.344	0.332	0.320	0.308	0.297	0.286
70	69.0	0.851	1487	0.371	0.357	0.345	0.332	0.320	0.308	0.297	0.286
72	68.6	0.903	1486	0.371	0.358	0.345	0.333	0.321	0.309	0.297	0.286
74	68.2	0.958	1484	0.371	0.358	0.345	0.333	0.321	0.309	0.298	0.287
76	67.9	1.016	1483	0.372	0.359	0.346	0.333	0.321	0.309	0.298	0.287
78	67.5	1.077	1481	0.372	0.359	0.346	0.334	0.322	0.310	0.298	0.287
80	67.1	1.140	1479	0.373	0.359	0.347	0.334	0.322	0.310	0.299	0.288
82	66.7	1.207	1478	0.373	0.360	0.347	0.334	0.322	0.310	0.299	0.288
84	66.4	1.277	1476	0.373	0.360	0.347	0.335	0.323	0.311	0.299	0.288
86	66.0	1.351	1475	0.374	0.361	0.348	0.335	0.323	0.311	0.300	0.289
88	65.6	1.428	1473	0.374	0.361	0.348	0.335	0.323	0.311	0.300	0.289
90	65.3	1.509	1471	0.375	0.361	0.348	0.336	0.324	0.312	0.300	0.289
92	64.9	1.594	1470	0.375	0.362	0.349	0.336	0.324	0.312	0.301	0.290
94	64.5	1.683	1468	0.375	0.362	0.349	0.337	0.324	0.313	0.301	0.290
96	64.1	1.776	1467	0.376	0.363	0.350	0.337	0.325	0.313	0.301	0.290
98	63.8	1.874	1465	0.376	0.363	0.350	0.337	0.325	0.313	0.302	0.290
100	63.4	1.976	1463	0.377	0.363	0.350	0.338	0.325	0.314	0.302	0.291
102	63.0	2.083	1462	0.377	0.364	0.351	0.338	0.326	0.314	0.302	0.291
104	62.7	2.195	1460	0.378	0.364	0.351	0.338	0.326	0.314	0.303	0.291
106	62.3	2.312	1459	0.378	0.364	0.351	0.339	0.326	0.315	0.303	0.292
108	61.9	2.434	1457	0.378	0.365	0.352	0.339	0.327	0.315	0.303	0.292
110	61.5	2.562	1455	0.379	0.365	0.352	0.340	0.327	0.315	0.304	0.292
112	61.2	2.695	1454	0.379	0.366	0.353	0.340	0.328	0.316	0.304	0.293
114	60.8	2.834	1452	0.380	0.366	0.353	0.340	0.328	0.316	0.304	0.293
116	60.4	2.980	1451	0.380	0.366	0.353	0.341	0.328	0.316	0.305	0.293
118	60.1	3.132	1449	0.380	0.367	0.354	0.341	0.329	0.317	0.305	0.294
120	59.7	3.290	1447	0.381	0.367	0.354	0.341	0.329	0.317	0.305	0.294

1/ Note that $C_1 = 0.622 K_1 \lambda p / BP$ and has units of lang/mb/mi.

Allen (1986) showed that the roughness parameters can be predicted using the height of the reference crop (h_c):

$$Z_{om} = 0.01025 h_c \quad [2-42]$$

$$Z_{ov} = 0.1 Z_{om} \quad [2-43]$$

For a clipped grass reference crop that is 5 inches tall, the roughness parameters are:

$$Z_{om} = 0.051 \text{ feet}$$

$$Z_{ov} = 0.0051 \text{ feet}$$

The displacement height (d) is estimated using the height of the reference crop (h_c):

$$d = \left(\frac{h_c}{18} \right) \quad [2-44]$$

Using these definitions, the aerodynamic resistance in units of days per mile is given by:

$$r_a = \frac{\text{LN} \left[\frac{97.56 Z_w}{h_c} - 5.42 \right] \text{LN} \left[\frac{975.6 Z_p}{h_c} - 54.2 \right]}{0.168 U_z} \quad [2-45]$$

where the heights Z_w and Z_p are in feet, h_c is in inches, and U_z is in miles per day. Values of the aerodynamic resistance are summarized for various configurations of weather stations and heights in table 2-12.

Jensen, et al. (1990) presented a way to estimate the canopy resistance (r_c) based upon the height and type of reference crop. The canopy resistance depends on the leaf area index of the reference crop:

$$r_c = \frac{1.863}{(0.5 \text{ LAI})} \quad [2-46]$$

where r_c is in units of days per mile and LAI is the leaf area index (i.e., the ratio of leaf area divided by the ground area). For a clipped grass less than 6 inches tall, Jensen, et al. (1990) recommended that:

$$\text{LAI} = 0.61 h_c \quad [2-47]$$

Using a constant reference crop height of 5 inches for clipped grass gives a constant canopy resistance of 1.22 days per mile.

Using these parameters, the values of γ^* , $\Delta/(\Delta + \gamma^*)$ and $\gamma/(\Delta + \gamma^*)$ can be computed. With these parameters, all terms are known for the Penman-Monteith method for a clipped grass reference crop at a height of 5 inches. The use of the Penman-Monteith method is illustrated in example 2-11.

A flow diagram was prepared for the calculations used in the Penman-Monteith method. The use of the flow diagram is illustrated in figure 2-16 for a day when the maximum and minimum temperature was 94 and 66 degrees Fahrenheit, respectively, the maximum and minimum relative humidities were 88 and 34 percent, dew point temperature was 62 degrees Fahrenheit, solar radiation was 695 langleys per day, and the wind run was 350 miles per day.

Example 2-11 assumes that wind, temperature, vapor pressure, and net radiation measurements were taken over the same type of vegetative surface as the reference crop. However, in practice, weather measurements are often taken above other surfaces. These surfaces often have vegetative heights, roughness, resistances, and corresponding temperature, vapor, and wind profiles that are different from those of the reference crop. Generally, the following procedure can be used to adjust the measured wind speed to reflect the type of conditions present at the weather station:

$$U_c = U_w \left[\frac{\text{LN} \left(\frac{97.56 Z}{h_c} - 5.42 \right)}{\text{LN} \left(\frac{97.56 Z}{h_w} - 5.42 \right)} \right] \quad [2-48]$$

where:

U_c = wind speed at height Z over the reference crop (mi/d)

U_w = wind speed at height Z over the crop at the weather station (mi/d)

h_w = height of crop in the weather station (in)

h_c = height of reference crop (in)

The wind speed measured at height Z over the reference crop (U_c) can then be adjusted to the desired height using equations 2-21 and 2-22, if needed.

Table 2-12 Aerodynamic resistance (r_a in d/mi) for various wind speeds and common configurations of weather stations (based on a grass reference height of 5 inches)

Wind run (mi/d)	Wind speed measured at 6.6 ft			Wind speed measured at 9.8 ft		
	Height of air temperature and relative humidity sensors (ft)			Height of air temperature and relative humidity sensors (ft)		
	3.3	4.9	6.6	3.3	4.9	6.6
5	36.57	39.01	40.80	39.68	42.32	44.27
10	18.28	19.50	20.40	19.84	21.16	22.14
15	12.19	13.00	13.60	13.23	14.11	14.76
20	9.14	9.75	10.20	9.92	10.58	11.07
25	7.31	7.80	8.16	7.94	8.46	8.85
50	3.66	3.90	4.08	3.97	4.23	4.43
75	2.44	2.60	2.72	2.65	2.82	2.95
100	1.83	1.95	2.04	1.98	2.12	2.21
125	1.46	1.56	1.63	1.59	1.69	1.77
150	1.22	1.30	1.36	1.32	1.41	1.48
175	1.04	1.11	1.17	1.13	1.21	1.26
200	0.91	0.98	1.02	0.99	1.06	1.11
225	0.81	0.87	0.91	0.88	0.94	0.98
250	0.73	0.78	0.82	0.79	0.85	0.89
275	0.66	0.71	0.74	0.72	0.77	0.80
300	0.61	0.65	0.68	0.66	0.71	0.74
325	0.56	0.60	0.63	0.61	0.65	0.68
350	0.52	0.56	0.58	0.57	0.60	0.63
375	0.49	0.52	0.54	0.53	0.56	0.59
400	0.46	0.49	0.51	0.50	0.53	0.55
425	0.43	0.46	0.48	0.47	0.50	0.52
450	0.41	0.43	0.45	0.44	0.47	0.49
475	0.38	0.41	0.43	0.42	0.45	0.47
500	0.37	0.39	0.41	0.40	0.42	0.44
525	0.35	0.37	0.39	0.38	0.40	0.42
550	0.33	0.35	0.37	0.36	0.38	0.40
575	0.32	0.34	0.35	0.35	0.37	0.38
600	0.30	0.33	0.34	0.33	0.35	0.37
625	0.29	0.31	0.33	0.32	0.34	0.35
650	0.28	0.30	0.31	0.31	0.33	0.34
675	0.27	0.29	0.30	0.29	0.31	0.33
700	0.26	0.28	0.29	0.28	0.30	0.32
725	0.25	0.27	0.28	0.27	0.29	0.31
750	0.24	0.26	0.27	0.26	0.28	0.30

Note: Heights of 3.3, 4.9, 6.6, and 9.8 feet correspond to 1, 1.5, 2, and 3 meters.

Figure 2-16 Flow diagram for computing ET_0 using the Penman-Monteith method

Date 7 / 20 Day of year 201
 Latitude 40 Elevation above sea level, ft 3000

Temperature and humidity relationships:

Quantity	Temp, °F	RH, %	e_z° , mb	e_z , mb
Maximum temp	94	34	54.5	18.5
Minimum Temp	66	88	21.8	19.2
Averages	80	XXXXXX	38.2	XXXXXX
Dew point temp	62	XXXXXX	$e_d = 19.0$	

Basic parameters

Δ for average temp $\Delta = 0.051 \left(\frac{164.8 + T_a}{157} \right)^7 = 0.051 \left(\frac{164.8 + 80}{157} \right)^7$	$\Delta, mb/^\circ F = 1.14$
Heat of vaporization (λ) $\lambda = 1543 - 0.796 T_a = 1543 - 0.796 \times 80$	$\lambda, lang/in = 1479$
Barometric pressure (BP) 3000 ft $BP = 1013 \left[1 - \frac{E_{lev}}{145,350} \right]^{5.26}$	$BP, mb = 908$
$\gamma = \frac{c_p BP}{0.622 \lambda} = \frac{0.339 \times 908}{0.622 \times 1,479}$ $c_p = 0.339 \text{ langleys/inch/}^\circ F$	$\gamma, mb/^\circ F = 0.33$

Soil heat flux

Average daily air temperatures, °F: Today (T_a) <u>80</u> Yesterday <u>86</u> Two days ago <u>83</u> Tree days ago <u>77</u> Average temp (T_p) <u>82</u>	$G = c_s (T_a - T_p) = 5 (80 - 82)$ $c_s = 5 \text{ langleys/}^\circ F/\text{day}$	$G, lang/d =$ -10
--	--	----------------------

Figure 2-16 Flow diagram for computing ET_o using the Penman-Monteith method—Continued**Radiation calculations**

$a_1 = 0.26 + 0.1 \text{ EXP} \left(- \left[\frac{0.0154 (\text{DOY} - 176)}{201} \right]^2 \right) = 0.346$ $\epsilon' = a_1 - 0.044 \sqrt{e_d} = 0.346 - 0.044 \sqrt{19.0}$	$\epsilon' =$ 0.154
$T_s^4 = \frac{1}{2} \left[\left(\frac{5}{9} T_{\text{max}} + 255.4 \right)^4 + \left(\frac{5}{9} T_{\text{min}} + 255.4 \right)^4 \right] = 8.11 \times 10^9$ $R_{bo} = \epsilon' \sigma T_s^4 = 0.154 \times 11.71 \times 10^{-8} \times 8.11 \times 10^9$	$R_{bo}, \text{ lang/ d} =$ 146
$A = 753.6 - 6.53 \text{ Lat} + 0.0057 E_{\text{lev}} = 753.6 - 6.53 \times 40 + 0.0057 \times 3000 = 510$ $B = -7.1 + 6.40 \text{ Lat} + 0.0030 E_{\text{lev}} = -7.1 + 6.4 \times 40 + 0.003 \times 3000 = 258$ $R_{so} = A + B \text{ COS} [0.9863 (\text{DOY} - 170)] = 510 + 258 \text{ COS} [0.9863 (201 - 170)]$	$R_{so}, \text{ lang/ d} =$ 732
<p>If R_s is measured record at right, otherwise \rightarrow</p> $R_s = \left[0.25 + 0.50 \frac{n}{N} \right] R_{so}$	$R_s, \text{ lang/ d} =$ 695
$R_b = \left[a \left(\frac{R_s}{R_{so}} \right) + b \right] R_{bo} = \left[1.126 \left(\frac{695}{732} \right) - 0.07 \right] 146$ <p>If $R_s / R_{so} > 0.7$ then $a = 1.126$ and $b = -0.07$ ✓ $R_s / R_{so} \leq 0.7$ then $a = 1.017$ and $b = -0.06$</p>	$R_b, \text{ lang/ d} =$ 146
$\theta_d = \text{SIN}^{-1} \left[0.39795 \text{ COS} \left\{ \frac{0.98563 (\text{DOY} - 173)}{201} \right\} \right] = 20.7^\circ$ $\theta_m = \text{SIN}^{-1} \left[\text{SIN}(\theta_d) \text{ SIN}(\text{Lat}) + \text{COS}(\theta_d) \text{ COS}(\text{Lat}) \right] = 70.7^\circ$ $\alpha = 0.108 + 0.000939 \theta_m + 0.257 \text{ EXP} \left(\frac{-\theta_m}{57.3} \right) = 0.249$ $R_n = (1 - \alpha) R_s - R_b = (1 - 0.249) 695 - 146$	$R_n, \text{ lang/ d} =$ 376

Figure 2-16 Flow diagram for computing ET_o using the Penman-Monteith method—Continued**Resistance Terms (r_a and r_c):**

<p> Z_w = height of wind speed measurement = 6.6 feet Z_p = height of air temperature measurement = 4.9 feet U_z = wind run = 350 miles/day r_c = 1.22 days/mile </p> <p>For a 5 inch tall grass reference crop</p> $r_a = \frac{\text{LN}\left(97.56 \frac{Z_w}{5} - 5.42\right) \text{LN}\left(975.6 \frac{Z_p}{5} - 54.2\right)}{0.168 U_z}$ <p style="text-align: center;"> $\gamma^* = \gamma \left(1 + \frac{r_c}{r_a}\right) = 0.33 \left(1 + \frac{1.22}{0.56}\right)$ </p>	<p> $r_c, d/mi =$ 1.22 $r_a, d/mi =$ 0.56 $\gamma^* = 1.05$ </p>
---	---

Reference crop ET (ET_o)

<p> $\frac{0.622 K_1 \lambda \rho}{BP} = 82 - 0.186 T_a = 82 - 0.186 \times 80 = 67.1$ </p> $ET_o = \left(\frac{1}{\lambda}\right) \left[\left(\frac{\Delta}{\Delta + \gamma^*}\right) (R_n - G) + \left(\frac{\gamma}{\Delta + \gamma^*}\right) \left(\frac{0.622 K_1 \lambda \rho}{BP}\right) \left(\frac{e_z^o - e_z}{r_a}\right) \right]$ $= \left(\frac{1}{1479}\right) \left[\left(\frac{1.14}{1.14 + 1.05}\right) (376 - (-10)) + \left(\frac{0.33}{1.14 + 1.05}\right) 67.1 \left(\frac{38.2 - 19}{0.56}\right) \right]$ $= \left(\frac{1}{1479}\right) [201 + 347]$	<p> $ET_o =$ 0.37 in/d </p>
---	--

(c) Radiation method

In some locations, climatic data required for the Penman-Monteith method are not available for the needed time period. In the evaluation by Jensen, et al. (1990), the radiation method developed by Doorenbos and Pruitt (1977) was the most accurate method that depends on solar radiation and air temperature data. This method performed very well for 9 of the 11 lysimeter sites evaluated. It was especially accurate in arid locations. However, the method greatly overestimated reference crop ET for the two lysimeter sites near the ocean in cool climates. The radiation method should not be used in such locations.

The radiation method from Doorenbos and Pruitt (1977) is given by:

$$ET_o = -0.012 + \left(\frac{\Delta}{\Delta + \gamma} \right) b_r \frac{R_s}{\lambda} \quad [2-49]$$

where:

- ET_o = evapotranspiration for clipped grass reference crop (in/d)
- Δ = slope of the vapor pressure curve (mb/°F)
(calculated by equation 2-16)
- γ = psychrometric constant (mb/°F)
(calculated by equation 2-18)
- b_r = adjustment factor depending on the average relative humidity and daytime wind speed
- R_s = incoming solar radiation (lang/d)
- λ = heat of vaporization of water (lang/in)
(equation 2-19)

The value of b_r was computed using the method recommended by Jensen, et al. (1990). It is presented in table 2-13. The average relative humidity for the adjustment factor is the average of the daily maximum and minimum relative humidities. Values for the terms in parenthesis in equation 2-49 are summarized in table 2-14. It is important to note that the values used to compute b_r are average values for the region, not daily measured values. Thus, once a value of b_r is determined for a time period at a given location, the value is constant and does not need to be computed again.

If measured solar radiation data are available, the radiation method can be easily used to reliably estimate ET_o for arid climates. When measured data are not available, estimates of solar radiation can be developed as described in 623.0202(f). Example 2-12 illustrates the use of the radiation method for June at the example site.

Example 2-12 ET_o —Radiation method

Determine: The reference crop evapotranspiration (ET_o) for June at the example site using the Radiation method.

Given: $R_s = 650$ lang/d
Average RH = 61%
Average wind run = 260 mi/d
 $\lambda = 1,484$ lang/in (from example 2-11, Penman-Monteith method)

Solution: Assume an average day-to-night wind speed ratio of 2.
Use table 2-5 to determine mean daytime wind speed to be 14.4 mi/hr, or 346 mi/d.
Use table 2-13 to determine adjustment factor b_r :
 $b_r = 1.04$

From example 2-11

$$\Delta = 0.97 \text{ mb} / ^\circ\text{F}$$

$$\gamma = 0.34 \text{ mb} / ^\circ\text{F}$$

$$\frac{\Delta}{(\Delta + \gamma)} = \frac{0.97}{(0.97 + 0.34)} = 0.74$$

$$ET_o = -0.012 + \left(0.74 \times 1.04 \times \frac{650}{1,484} \right)$$

$$ET_o = 0.33 \text{ in} / \text{d}$$

Table 2-13 Adjustment factor b_r for the radiation method ^{1/}

Average daytime wind speed (mi/d)	Average relative humidity (%)									
	10	20	30	40	50	60	70	80	90	100
0	1.05	1.03	1.00	0.96	0.92	0.87	0.82	0.76	0.69	0.62
20	1.07	1.04	1.01	0.98	0.94	0.89	0.83	0.77	0.70	0.63
40	1.08	1.06	1.03	0.99	0.95	0.90	0.84	0.78	0.71	0.64
60	1.10	1.07	1.04	1.00	0.96	0.91	0.85	0.79	0.72	0.65
80	1.11	1.09	1.05	1.02	0.97	0.92	0.86	0.80	0.73	0.66
100	1.13	1.10	1.07	1.03	0.98	0.93	0.87	0.81	0.74	0.66
120	1.14	1.11	1.08	1.04	1.00	0.94	0.88	0.82	0.75	0.67
140	1.15	1.13	1.09	1.05	1.01	0.95	0.89	0.83	0.76	0.68
160	1.17	1.14	1.11	1.06	1.02	0.96	0.90	0.84	0.76	0.69
180	1.18	1.15	1.12	1.08	1.03	0.97	0.91	0.85	0.77	0.69
200	1.19	1.16	1.13	1.09	1.04	0.98	0.92	0.85	0.78	0.70
220	1.21	1.18	1.14	1.10	1.05	0.99	0.93	0.86	0.79	0.70
240	1.22	1.19	1.15	1.11	1.06	1.00	0.94	0.87	0.79	0.71
260	1.23	1.20	1.16	1.12	1.07	1.01	0.95	0.88	0.80	0.72
280	1.24	1.21	1.17	1.13	1.07	1.02	0.95	0.88	0.80	0.72
300	1.26	1.22	1.18	1.14	1.08	1.02	0.96	0.89	0.81	0.73
320	1.27	1.23	1.19	1.15	1.09	1.03	0.97	0.89	0.82	0.73
340	1.28	1.24	1.20	1.15	1.10	1.04	0.97	0.90	0.82	0.74
360	1.29	1.25	1.21	1.16	1.11	1.05	0.98	0.91	0.83	0.74
380	1.30	1.26	1.22	1.17	1.11	1.05	0.98	0.91	0.83	0.74
400	1.31	1.27	1.23	1.18	1.12	1.06	0.99	0.92	0.83	0.75
420	1.32	1.28	1.24	1.19	1.13	1.07	1.00	0.92	0.84	0.75
440	1.33	1.29	1.24	1.19	1.14	1.07	1.00	0.92	0.84	0.75
460	1.34	1.30	1.25	1.20	1.14	1.08	1.01	0.93	0.84	0.75
480	1.35	1.31	1.26	1.21	1.15	1.08	1.01	0.93	0.85	0.76
500	1.35	1.31	1.27	1.21	1.15	1.09	1.01	0.94	0.85	0.76
520	1.36	1.32	1.27	1.22	1.16	1.09	1.02	0.94	0.85	0.76
540	1.37	1.33	1.28	1.22	1.16	1.10	1.02	0.94	0.85	0.76
560	1.38	1.34	1.29	1.23	1.17	1.10	1.02	0.94	0.86	0.76
580	1.39	1.34	1.29	1.23	1.17	1.10	1.03	0.95	0.86	0.76
600	1.39	1.35	1.30	1.24	1.18	1.11	1.03	0.95	0.86	0.76
620	1.40	1.35	1.30	1.24	1.18	1.11	1.03	0.95	0.86	0.76
640	1.41	1.36	1.31	1.25	1.18	1.11	1.03	0.95	0.86	0.76
660	1.41	1.37	1.31	1.25	1.19	1.11	1.04	0.95	0.86	0.76
680	1.42	1.37	1.32	1.26	1.19	1.12	1.04	0.95	0.86	0.76
700	1.42	1.38	1.32	1.26	1.19	1.12	1.04	0.95	0.86	0.76
720	1.43	1.38	1.32	1.26	1.19	1.12	1.04	0.95	0.86	0.76

1/ The equation used to compute b_r is:

$$b_r = 1.06 - 0.0013 RH_a + 8.38 \times 10^{-4} U_d - 3.73 \times 10^{-6} RH_a U_d - 0.315 \times 10^{-4} RH_a^2 - 3.82 \times 10^{-7} U_d^2$$

where:

RH_a = average relative humidity (%)

U_d = average daytime wind speed (mi/d)

Table 2-14 Value of parameters used with the radiation method

Air temp (°F)	Δ (mb/°F)	λ (lang/in)	$\frac{\Delta}{\Delta+\gamma}$ for elevations above sea level, ft-----							
			0	1,000	2,000	3,000	4,000	5,000	6,000	7,000
32	0.248	1518	0.405	0.414	0.423	0.432	0.441	0.450	0.460	0.469
34	0.266	1516	0.422	0.431	0.440	0.449	0.458	0.468	0.477	0.487
36	0.286	1514	0.439	0.448	0.457	0.466	0.476	0.485	0.494	0.504
38	0.306	1513	0.456	0.465	0.474	0.483	0.493	0.502	0.511	0.521
40	0.328	1511	0.473	0.482	0.491	0.500	0.510	0.519	0.528	0.538
42	0.351	1510	0.490	0.499	0.508	0.517	0.526	0.536	0.545	0.554
44	0.375	1508	0.506	0.515	0.524	0.534	0.543	0.552	0.561	0.571
46	0.401	1506	0.523	0.532	0.541	0.550	0.559	0.568	0.577	0.587
48	0.429	1505	0.539	0.548	0.557	0.566	0.575	0.584	0.593	0.602
50	0.458	1503	0.555	0.564	0.573	0.582	0.591	0.600	0.609	0.618
52	0.488	1502	0.570	0.579	0.588	0.597	0.606	0.615	0.624	0.633
54	0.521	1500	0.586	0.595	0.603	0.612	0.621	0.630	0.638	0.647
56	0.555	1498	0.601	0.610	0.618	0.627	0.636	0.644	0.653	0.661
58	0.591	1497	0.616	0.624	0.633	0.641	0.650	0.658	0.667	0.675
60	0.629	1495	0.630	0.639	0.647	0.655	0.664	0.672	0.680	0.688
62	0.670	1494	0.644	0.653	0.661	0.669	0.677	0.685	0.693	0.701
64	0.712	1492	0.658	0.666	0.674	0.682	0.690	0.698	0.706	0.714
66	0.757	1490	0.671	0.679	0.687	0.695	0.703	0.711	0.718	0.726
68	0.804	1489	0.684	0.692	0.700	0.708	0.715	0.723	0.730	0.738
70	0.853	1487	0.697	0.704	0.712	0.720	0.727	0.734	0.742	0.749
72	0.906	1486	0.709	0.716	0.724	0.731	0.738	0.746	0.753	0.760
74	0.961	1484	0.721	0.728	0.735	0.742	0.749	0.756	0.763	0.770
76	1.018	1483	0.732	0.739	0.746	0.753	0.760	0.767	0.773	0.780
78	1.079	1481	0.743	0.750	0.757	0.764	0.770	0.777	0.783	0.790
80	1.143	1479	0.754	0.760	0.767	0.774	0.780	0.786	0.793	0.799
82	1.210	1478	0.764	0.771	0.777	0.783	0.789	0.796	0.802	0.808
84	1.280	1476	0.774	0.780	0.786	0.792	0.799	0.804	0.810	0.816
86	1.354	1475	0.783	0.789	0.795	0.801	0.807	0.813	0.819	0.824
88	1.431	1473	0.792	0.798	0.804	0.810	0.816	0.821	0.827	0.832
90	1.512	1471	0.801	0.807	0.813	0.818	0.824	0.829	0.834	0.839
92	1.597	1470	0.810	0.815	0.821	0.826	0.831	0.836	0.841	0.846
94	1.687	1468	0.818	0.823	0.828	0.833	0.839	0.844	0.848	0.853
96	1.780	1467	0.825	0.831	0.836	0.841	0.846	0.850	0.855	0.860
98	1.878	1465	0.833	0.838	0.843	0.848	0.852	0.857	0.861	0.866
100	1.980	1463	0.840	0.845	0.850	0.854	0.859	0.863	0.868	0.872
102	2.087	1462	0.847	0.851	0.856	0.860	0.865	0.869	0.873	0.878
104	2.199	1460	0.853	0.858	0.862	0.867	0.871	0.875	0.879	0.883
106	2.316	1459	0.860	0.864	0.868	0.872	0.876	0.880	0.884	0.888
108	2.439	1457	0.866	0.870	0.874	0.878	0.882	0.886	0.889	0.893
110	2.567	1455	0.871	0.875	0.879	0.883	0.887	0.891	0.894	0.898
112	2.700	1454	0.877	0.881	0.884	0.888	0.892	0.895	0.899	0.902
114	2.840	1452	0.882	0.886	0.889	0.893	0.896	0.900	0.903	0.906
116	2.986	1451	0.887	0.891	0.894	0.897	0.901	0.904	0.907	0.910
118	3.138	1449	0.892	0.895	0.899	0.902	0.905	0.908	0.911	0.914
120	3.296	1447	0.896	0.900	0.903	0.906	0.909	0.912	0.915	0.918

(d) Temperature method

Estimates of crop water use based solely on air temperature have been widely used in several places of the United States and internationally. Jensen, et al. (1990) found that the version of the Blaney-Criddle method developed by Doorenbos and Pruitt (1977) was the most accurate temperature-based method evaluated for estimating crop ET_o . This technique, commonly referred to as the FAO-Blaney-Criddle method, is described by:

$$ET_o = c_e(a_t + b_t pT) \quad [2-50]$$

where:

- ET_o = evapotranspiration for clipped grass reference crop (in/d)
- p = mean daily percent of annual daytime hours
- T = mean air temperature for the period ($^{\circ}F$)
- a_t and b_t = adjustment factors based on the climate of the region
- c_e = adjustment factor based on elevation above sea level

Values of a_t are presented in table 2-15 as a function of the mean minimum relative humidity in percent (RH_{min}) and the mean ratio of actual to possible sunshine hours (n/N).

The value of b_t depends on the minimum relative humidity, sunshine ratio, and the mean day time wind speed. Adjustment factor b_t can be computed as:

$$b_t = b_n + b_u \quad [2-51]$$

Values of b_n and b_u are summarized in tables 2-16 and 2-17, respectively, along with the equations to use in calculating these factors.

The climatic parameters used to compute a_t and b_t are regional average values, not daily measured values. Thus, once values of a_t and b_t are determined for a time of year and a location, they can be used for different days in the period and for all years analyzed.

The elevation correction factor c_e is given as:

$$c_e = 0.01 + 3.049 \times 10^{-7} E_{lev} \quad [2-52]$$

where:

E_{lev} = elevation above sea level, ft.

The mean daily percent of annual daytime hours (p) is the ratio of the hours of daylight for a day in the middle of the respective month, relative to the hours of daylight for the year. Values of p are listed in table 2-18 as a function of latitude. The mean daily percent of annual daytime hours (p) can be computed from:

$$p = 0.00304 \cos^{-1} \left[\frac{-\sin(\theta_d) \sin(\text{Lat})}{\cos(\theta_d) \cos(\text{Lat})} \right] \quad [2-53]$$

with:

$$\theta_d = \sin^{-1} \{ 0.39795 \cos[0.98563(\text{DOY} - 173)] \}$$

where:

- θ_d = solar declination angle (degrees)
- DOY = day of year (see Appendix B, Day of Year Calendar)
- Lat = latitude ($^{\circ}N$)

Calculations for the southern latitudes require a shift in time of 6 months as shown in table 2-18. For the southern hemisphere, the constant -173 in equation 2-53 should be replaced with +9.5 to compute p .

Example 2-13 illustrates computation of average ET_o for June at the example site using the FAO Blaney-Criddle method.

Example 2-13 FAO Blaney-Criddle

Compute: ET_o for June at the example site.

Given: Average daily temperature = 74.5 °F
 $n/N = 0.74$
 Elevation = 2,600 feet
 Latitude = 38° N

Using data as in example 2-2, vapor pressure deficit:

$$e_d = 15.9 \text{ mb and } e_{T_{\max}}^o = 45.2 \text{ mb}$$

From example 2-12, ET_o —Radiation method:

Mean daytime wind speed = 346 mi/d

Solution: Mean minimum relative humidity $(RH_{\min}) = \left(\frac{e_d}{e_{T_{\max}}^o} \right) 100$

$$RH_{\min} = \left(\frac{15.9 \text{ mb}}{45.2 \text{ mb}} \right) \times 100 = 35\%$$

$$c_e = 0.01 + 3.049 \times 10^{-7} \times 2,600 = 0.0108$$

Using table 2-15 $a_t = -7.9$

Using table 2-16 $b_n = 1.31$

Using table 2-17 $b_u = 0.29$

Using table 2-18 $p = 0.33$

$$b_t = 1.31 + 0.29 = 1.60$$

From equation 2-50:

$$ET_o = c_e (a_t + b_t p T)$$

$$ET_o = 0.0108 \times [-7.9 + (1.60 \times 0.33 \times 74.5)]$$

$$ET_o = 0.34 \text{ in / day}$$

Table 2-15 Values of adjustment factor a_t for use in equation 2-50 ^{1/}

Mean minimum relative humidity (%)	----- Ratio of actual to possible sunshine (n/N) -----									
	0.1	0.2	0.3	0.4	0.5	0.6	0.7	0.8	0.9	1.0
10	-5.78	-6.17	-6.56	-6.96	-7.35	-7.74	-8.14	-8.53	-8.93	-9.32
12	-5.74	-6.14	-6.53	-6.92	-7.32	-7.71	-8.10	-8.50	-8.89	-9.29
14	-5.71	-6.10	-6.50	-6.89	-7.28	-7.68	-8.07	-8.46	-8.86	-9.25
16	-5.67	-6.07	-6.46	-6.86	-7.25	-7.64	-8.04	-8.43	-8.82	-9.22
18	-5.64	-6.03	-6.43	-6.82	-7.21	-7.61	-8.00	-8.40	-8.79	-9.18
20	-5.61	-6.00	-6.39	-6.79	-7.18	-7.57	-7.97	-8.36	-8.76	-9.15
22	-5.57	-5.97	-6.36	-6.75	-7.15	-7.54	-7.93	-8.33	-8.72	-9.12
24	-5.54	-5.93	-6.33	-6.72	-7.11	-7.51	-7.90	-8.29	-8.69	-9.08
26	-5.50	-5.90	-6.29	-6.69	-7.08	-7.47	-7.87	-8.26	-8.65	-9.05
28	-5.47	-5.86	-6.26	-6.65	-7.05	-7.44	-7.83	-8.23	-8.62	-9.01
30	-5.44	-5.83	-6.22	-6.62	-7.01	-7.41	-7.80	-8.19	-8.59	-8.98
32	-5.40	-5.80	-6.19	-6.58	-6.98	-7.37	-7.77	-8.16	-8.55	-8.95
34	-5.37	-5.76	-6.16	-6.55	-6.94	-7.34	-7.73	-8.13	-8.52	-8.91
36	-5.34	-5.73	-6.12	-6.52	-6.91	-7.30	-7.70	-8.09	-8.49	-8.88
38	-5.30	-5.70	-6.09	-6.48	-6.88	-7.27	-7.66	-8.06	-8.45	-8.84
40	-5.27	-5.66	-6.06	-6.45	-6.84	-7.24	-7.63	-8.02	-8.42	-8.81
42	-5.23	-5.63	-6.02	-6.41	-6.81	-7.20	-7.60	-7.99	-8.38	-8.78
44	-5.20	-5.59	-5.99	-6.38	-6.77	-7.17	-7.56	-7.96	-8.35	-8.74
46	-5.17	-5.56	-5.95	-6.35	-6.74	-7.13	-7.53	-7.92	-8.32	-8.71
48	-5.13	-5.53	-5.92	-6.31	-6.71	-7.10	-7.49	-7.89	-8.28	-8.68
50	-5.10	-5.49	-5.89	-6.28	-6.67	-7.07	-7.46	-7.85	-8.25	-8.64
52	-5.06	-5.46	-5.85	-6.25	-6.64	-7.03	-7.43	-7.82	-8.21	-8.61
54	-5.03	-5.42	-5.82	-6.21	-6.61	-7.00	-7.39	-7.79	-8.18	-8.57
56	-5.00	-5.39	-5.78	-6.18	-6.57	-6.97	-7.36	-7.75	-8.15	-8.54
58	-4.96	-5.36	-5.75	-6.14	-6.54	-6.93	-7.33	-7.72	-8.11	-8.51
60	-4.93	-5.32	-5.72	-6.11	-6.50	-6.90	-7.29	-7.69	-8.08	-8.47
62	-4.90	-5.29	-5.68	-6.08	-6.47	-6.86	-7.26	-7.65	-8.04	-8.44
64	-4.86	-5.26	-5.65	-6.04	-6.44	-6.83	-7.22	-7.62	-8.01	-8.40
66	-4.83	-5.22	-5.61	-6.01	-6.40	-6.80	-7.19	-7.58	-7.98	-8.37
68	-4.79	-5.19	-5.58	-5.97	-6.37	-6.76	-7.16	-7.55	-7.94	-8.34
70	-4.76	-5.15	-5.55	-5.94	-6.33	-6.73	-7.12	-7.52	-7.91	-8.30
72	-4.73	-5.12	-5.51	-5.91	-6.30	-6.69	-7.09	-7.48	-7.88	-8.27
74	-4.69	-5.09	-5.48	-5.87	-6.27	-6.66	-7.05	-7.45	-7.84	-8.24
76	-4.66	-5.05	-5.45	-5.84	-6.23	-6.63	-7.02	-7.41	-7.81	-8.20
78	-4.62	-5.02	-5.41	-5.81	-6.20	-6.59	-6.99	-7.38	-7.77	-8.17
80	-4.59	-4.98	-5.38	-5.77	-6.17	-6.56	-6.95	-7.35	-7.74	-8.13
82	-4.56	-4.95	-5.34	-5.74	-6.13	-6.53	-6.92	-7.31	-7.71	-8.10
84	-4.52	-4.92	-5.31	-5.70	-6.10	-6.49	-6.89	-7.28	-7.67	-8.07
86	-4.49	-4.88	-5.28	-5.67	-6.06	-6.46	-6.85	-7.24	-7.64	-8.03
88	-4.46	-4.85	-5.24	-5.64	-6.03	-6.42	-6.82	-7.21	-7.60	-8.00
90	-4.42	-4.81	-5.21	-5.60	-6.00	-6.39	-6.78	-7.18	-7.57	-7.96

$$1/ \quad a_t = 3.937 \left(0.0043 \text{RH}_{\min} - \frac{n}{N} - 1.41 \right)$$

Table 2-16 Values of adjustment factor b_n for use in equation 2-51 ^{1/}

Mean minimum relative humidity (%)	----- Ratio of actual to possible sunshine (n/N) -----									
	0.1	0.2	0.3	0.4	0.5	0.6	0.7	0.8	0.9	1.0
10	0.88	0.98	1.08	1.18	1.28	1.39	1.49	1.59	1.69	1.79
12	0.87	0.97	1.07	1.17	1.27	1.37	1.47	1.57	1.67	1.77
14	0.86	0.96	1.06	1.16	1.26	1.35	1.45	1.55	1.65	1.75
16	0.85	0.95	1.05	1.14	1.24	1.34	1.44	1.53	1.63	1.73
18	0.84	0.94	1.03	1.13	1.23	1.32	1.42	1.52	1.61	1.71
20	0.83	0.93	1.02	1.12	1.21	1.31	1.40	1.50	1.59	1.69
22	0.82	0.92	1.01	1.11	1.20	1.29	1.39	1.48	1.57	1.67
24	0.81	0.91	1.00	1.09	1.18	1.28	1.37	1.46	1.56	1.65
26	0.80	0.90	0.99	1.08	1.17	1.26	1.35	1.44	1.54	1.63
28	0.80	0.89	0.98	1.07	1.16	1.25	1.34	1.43	1.52	1.61
30	0.79	0.88	0.96	1.05	1.14	1.23	1.32	1.41	1.50	1.59
32	0.78	0.86	0.95	1.04	1.13	1.22	1.30	1.39	1.48	1.57
34	0.77	0.85	0.94	1.03	1.11	1.20	1.29	1.37	1.46	1.55
36	0.76	0.84	0.93	1.01	1.10	1.18	1.27	1.36	1.44	1.53
38	0.75	0.83	0.92	1.00	1.09	1.17	1.25	1.34	1.42	1.51
40	0.74	0.82	0.91	0.99	1.07	1.15	1.24	1.32	1.40	1.49
42	0.73	0.81	0.89	0.98	1.06	1.14	1.22	1.30	1.38	1.47
44	0.72	0.80	0.88	0.96	1.04	1.12	1.20	1.28	1.37	1.45
46	0.71	0.79	0.87	0.95	1.03	1.11	1.19	1.27	1.35	1.43
48	0.70	0.78	0.86	0.94	1.01	1.09	1.17	1.25	1.33	1.41
50	0.69	0.77	0.85	0.92	1.00	1.08	1.15	1.23	1.31	1.39
52	0.68	0.76	0.83	0.91	0.99	1.06	1.14	1.21	1.29	1.36
54	0.67	0.75	0.82	0.90	0.97	1.05	1.12	1.20	1.27	1.34
56	0.66	0.74	0.81	0.88	0.96	1.03	1.10	1.18	1.25	1.32
58	0.65	0.73	0.80	0.87	0.94	1.02	1.09	1.16	1.23	1.30
60	0.65	0.72	0.79	0.86	0.93	1.00	1.07	1.14	1.21	1.28
62	0.64	0.71	0.78	0.85	0.91	0.98	1.05	1.12	1.19	1.26
64	0.63	0.69	0.76	0.83	0.90	0.97	1.04	1.11	1.18	1.24
66	0.62	0.68	0.75	0.82	0.89	0.95	1.02	1.09	1.16	1.22
68	0.61	0.67	0.74	0.81	0.87	0.94	1.00	1.07	1.14	1.20
70	0.60	0.66	0.73	0.79	0.86	0.92	0.99	1.05	1.12	1.18
72	0.59	0.65	0.72	0.78	0.84	0.91	0.97	1.04	1.10	1.16
74	0.58	0.64	0.70	0.77	0.83	0.89	0.95	1.02	1.08	1.14
76	0.57	0.63	0.69	0.75	0.82	0.88	0.94	1.00	1.06	1.12
78	0.56	0.62	0.68	0.74	0.80	0.86	0.92	0.98	1.04	1.10
80	0.55	0.61	0.67	0.73	0.79	0.85	0.91	0.96	1.02	1.08
82	0.54	0.60	0.66	0.72	0.77	0.83	0.89	0.95	1.00	1.06
84	0.53	0.59	0.65	0.70	0.76	0.82	0.87	0.93	0.99	1.04
86	0.52	0.58	0.63	0.69	0.74	0.80	0.86	0.91	0.97	1.02
88	0.51	0.57	0.62	0.68	0.73	0.78	0.84	0.89	0.95	1.00
90	0.50	0.56	0.61	0.66	0.72	0.77	0.82	0.88	0.93	0.98

1/ $b_n = 0.82 - 0.0041 RH_{\min} + 1.07 \frac{n}{N} - 0.006 RH_{\min} \frac{n}{N}$

Table 2-17 Values of adjustment factor b_u for use in equation 2-51 ^{1/}

Mean minimum relative humidity (%)	----- Mean daytime wind speed at 2 meters above the ground, mi/d -----												
	50	100	150	200	250	300	350	400	450	500	600	700	800
10	0.06	0.11	0.17	0.22	0.28	0.34	0.39	0.45	0.50	0.56	0.67	0.78	0.90
12	0.05	0.11	0.16	0.22	0.27	0.33	0.38	0.44	0.49	0.55	0.66	0.77	0.88
14	0.05	0.11	0.16	0.21	0.27	0.32	0.38	0.43	0.48	0.54	0.64	0.75	0.86
16	0.05	0.11	0.16	0.21	0.26	0.32	0.37	0.42	0.47	0.53	0.63	0.74	0.84
18	0.05	0.10	0.15	0.21	0.26	0.31	0.36	0.41	0.46	0.52	0.62	0.72	0.82
20	0.05	0.10	0.15	0.20	0.25	0.30	0.35	0.40	0.45	0.50	0.60	0.71	0.81
22	0.05	0.10	0.15	0.20	0.25	0.30	0.34	0.39	0.44	0.49	0.59	0.69	0.79
24	0.05	0.10	0.14	0.19	0.24	0.29	0.34	0.39	0.43	0.48	0.58	0.67	0.77
26	0.05	0.09	0.14	0.19	0.24	0.28	0.33	0.38	0.42	0.47	0.56	0.66	0.75
28	0.05	0.09	0.14	0.18	0.23	0.28	0.32	0.37	0.41	0.46	0.55	0.64	0.73
30	0.04	0.09	0.13	0.18	0.22	0.27	0.31	0.36	0.40	0.45	0.54	0.63	0.72
32	0.04	0.09	0.13	0.17	0.22	0.26	0.31	0.35	0.39	0.44	0.52	0.61	0.70
34	0.04	0.09	0.13	0.17	0.21	0.26	0.30	0.34	0.38	0.43	0.51	0.60	0.68
36	0.04	0.08	0.12	0.17	0.21	0.25	0.29	0.33	0.37	0.41	0.50	0.58	0.66
38	0.04	0.08	0.12	0.16	0.20	0.24	0.28	0.32	0.36	0.40	0.48	0.56	0.65
40	0.04	0.08	0.12	0.16	0.20	0.24	0.27	0.31	0.35	0.39	0.47	0.55	0.63
42	0.04	0.08	0.11	0.15	0.19	0.23	0.27	0.30	0.34	0.38	0.46	0.53	0.61
44	0.04	0.07	0.11	0.15	0.18	0.22	0.26	0.30	0.33	0.37	0.44	0.52	0.59
46	0.04	0.07	0.11	0.14	0.18	0.22	0.25	0.29	0.32	0.36	0.43	0.50	0.57
48	0.03	0.07	0.10	0.14	0.17	0.21	0.24	0.28	0.31	0.35	0.42	0.49	0.56
50	0.03	0.07	0.10	0.13	0.17	0.20	0.24	0.27	0.30	0.34	0.40	0.47	0.54
52	0.03	0.07	0.10	0.13	0.16	0.20	0.23	0.26	0.29	0.33	0.39	0.46	0.52
54	0.03	0.06	0.09	0.13	0.16	0.19	0.22	0.25	0.28	0.31	0.38	0.44	0.50
56	0.03	0.06	0.09	0.12	0.15	0.18	0.21	0.24	0.27	0.30	0.36	0.42	0.48
58	0.03	0.06	0.09	0.12	0.15	0.17	0.20	0.23	0.26	0.29	0.35	0.41	0.47
60	0.03	0.06	0.08	0.11	0.14	0.17	0.20	0.22	0.25	0.28	0.34	0.39	0.45
62	0.03	0.05	0.08	0.11	0.13	0.16	0.19	0.22	0.24	0.27	0.32	0.38	0.43
64	0.03	0.05	0.08	0.10	0.13	0.15	0.18	0.21	0.23	0.26	0.31	0.36	0.41
66	0.02	0.05	0.07	0.10	0.12	0.15	0.17	0.20	0.22	0.25	0.30	0.35	0.39
68	0.02	0.05	0.07	0.09	0.12	0.14	0.16	0.19	0.21	0.24	0.28	0.33	0.38
70	0.02	0.04	0.07	0.09	0.11	0.13	0.16	0.18	0.20	0.22	0.27	0.31	0.36
72	0.02	0.04	0.06	0.09	0.11	0.13	0.15	0.17	0.19	0.21	0.26	0.30	0.34
74	0.02	0.04	0.06	0.08	0.10	0.12	0.14	0.16	0.18	0.20	0.24	0.28	0.32
76	0.02	0.04	0.06	0.08	0.10	0.11	0.13	0.15	0.17	0.19	0.23	0.27	0.31
78	0.02	0.04	0.05	0.07	0.09	0.11	0.13	0.14	0.16	0.18	0.22	0.25	0.29
80	0.02	0.03	0.05	0.07	0.08	0.10	0.12	0.13	0.15	0.17	0.20	0.24	0.27
82	0.02	0.03	0.05	0.06	0.08	0.09	0.11	0.13	0.14	0.16	0.19	0.22	0.25
84	0.01	0.03	0.04	0.06	0.07	0.09	0.10	0.12	0.13	0.15	0.18	0.20	0.23
86	0.01	0.03	0.04	0.05	0.07	0.08	0.09	0.11	0.12	0.13	0.16	0.19	0.22
88	0.01	0.02	0.04	0.05	0.06	0.07	0.09	0.10	0.11	0.12	0.15	0.17	0.20
90	0.01	0.02	0.03	0.05	0.06	0.07	0.08	0.09	0.10	0.11	0.14	0.16	0.18

$$1/ b_u = \frac{(1.23 U_d - 0.0112 RH_{\min} U_d)}{1,000}$$

Table 2-18 Daily percent of annual daytime hours (p)

Latitude North	Jan	Feb	Mar	Apr	May	June	July	Aug	Sept	Oct	Nov	Dec
64	0.11	0.18	0.26	0.33	0.41	0.46	0.44	0.36	0.29	0.21	0.14	0.09
62	0.13	0.19	0.26	0.33	0.39	0.44	0.42	0.36	0.29	0.22	0.15	0.11
60	0.15	0.20	0.26	0.32	0.38	0.42	0.40	0.35	0.29	0.22	0.16	0.13
58	0.16	0.20	0.26	0.32	0.37	0.41	0.39	0.34	0.29	0.23	0.17	0.14
56	0.17	0.21	0.26	0.32	0.36	0.39	0.38	0.34	0.29	0.23	0.18	0.15
54	0.18	0.21	0.26	0.31	0.36	0.38	0.37	0.33	0.28	0.23	0.19	0.16
52	0.18	0.22	0.26	0.31	0.35	0.38	0.37	0.33	0.28	0.24	0.20	0.17
50	0.19	0.22	0.26	0.31	0.35	0.37	0.36	0.33	0.28	0.24	0.20	0.18
48	0.20	0.23	0.26	0.30	0.34	0.36	0.35	0.32	0.28	0.24	0.21	0.19
46	0.20	0.23	0.27	0.30	0.34	0.35	0.35	0.32	0.28	0.24	0.21	0.19
44	0.21	0.23	0.27	0.30	0.33	0.35	0.34	0.32	0.28	0.25	0.22	0.20
42	0.21	0.24	0.27	0.30	0.33	0.34	0.34	0.31	0.28	0.25	0.22	0.20
40	0.22	0.24	0.27	0.30	0.32	0.34	0.33	0.31	0.28	0.25	0.22	0.21
38	0.22	0.24	0.27	0.30	0.32	0.33	0.33	0.31	0.28	0.25	0.23	0.21
36	0.22	0.24	0.27	0.29	0.32	0.33	0.32	0.30	0.28	0.25	0.23	0.22
34	0.23	0.25	0.27	0.29	0.31	0.33	0.32	0.30	0.28	0.25	0.23	0.22
32	0.23	0.25	0.27	0.29	0.31	0.32	0.32	0.30	0.28	0.26	0.24	0.23
30	0.23	0.25	0.27	0.29	0.31	0.32	0.31	0.30	0.28	0.26	0.24	0.23
28	0.24	0.25	0.27	0.29	0.31	0.31	0.31	0.30	0.28	0.26	0.24	0.23
26	0.24	0.25	0.27	0.29	0.30	0.31	0.31	0.29	0.28	0.26	0.24	0.24
24	0.24	0.26	0.27	0.29	0.30	0.31	0.30	0.29	0.28	0.26	0.25	0.24
22	0.25	0.26	0.27	0.29	0.30	0.30	0.30	0.29	0.28	0.26	0.25	0.24
20	0.25	0.26	0.27	0.28	0.30	0.30	0.30	0.29	0.28	0.26	0.25	0.25
18	0.25	0.26	0.27	0.28	0.29	0.30	0.30	0.29	0.28	0.26	0.25	0.25
16	0.25	0.26	0.27	0.28	0.29	0.30	0.29	0.29	0.28	0.27	0.26	0.25
14	0.26	0.26	0.27	0.28	0.29	0.29	0.29	0.28	0.28	0.27	0.26	0.26
12	0.26	0.27	0.27	0.28	0.29	0.29	0.29	0.28	0.28	0.27	0.26	0.26
10	0.26	0.27	0.27	0.28	0.28	0.29	0.29	0.28	0.28	0.27	0.26	0.26
8	0.26	0.27	0.27	0.28	0.28	0.28	0.28	0.28	0.28	0.27	0.27	0.26
6	0.27	0.27	0.27	0.28	0.28	0.28	0.28	0.28	0.27	0.27	0.27	0.27
4	0.27	0.27	0.27	0.28	0.28	0.28	0.28	0.28	0.27	0.27	0.27	0.27
2	0.27	0.27	0.27	0.27	0.28	0.28	0.28	0.28	0.27	0.27	0.27	0.27
0	0.27	0.27	0.27	0.27	0.27	0.27	0.27	0.27	0.27	0.27	0.27	0.27
Latitude South	July	Aug	Sept	Oct	Nov	Dec	Jan	Feb	Mar	Apr	May	June

(e) Evaporation pan method

Reference crop water evapotranspiration can be estimated by measuring the rate of evaporation from a shallow, open-faced pan. When the pan is installed to specific recommendations, it is referred to as a Class A standard pan. Class A evaporation pans are mounted on an open wooden frame with the bottom of the pan 6 inches above the ground (fig. 2-17). The water level in the pan should be maintained 2 to 3 inches below the rim of the pan. The pan should be painted with aluminum paint annually, and water should be replaced as needed to prevent turbidity. The water added to the pan should be at the same temperature as the water in the pan.

Figure 2-17 Schematic diagram of a Class A evaporation pan

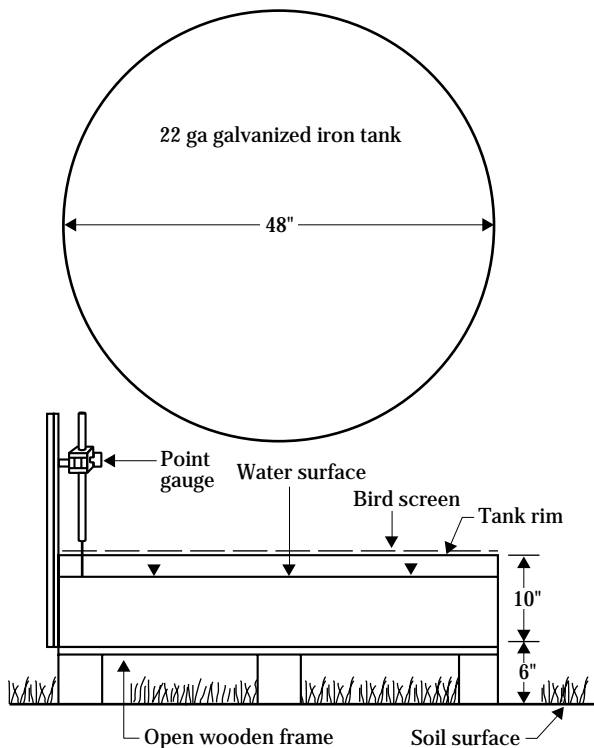

The reference crop ET can be approximated by multiplying the pan evaporation times a parameter called the pan coefficient:

$$ET_o = k_p E_{\text{pan}} \quad [2-54]$$

where:

ET_o = the evapotranspiration for a clipped grass reference crop (in/d)

k_p = pan coefficient

E_{pan} = evaporation from the pan (in/d)

Doorenbos and Pruitt (1977) developed a procedure to predict k_p for Class A evaporation pans. The pan coefficient for Class A pans varies depending on the climate and the type of soil cover surrounding the pan. Doorenbos and Pruitt defined two general cases that represent conditions surrounding most pans (table 2-19). Based on the type of installation, an approximate pan coefficient can be determined using the average daily wind speed and the mean relative humidity. For the example site, the mean relative humidity in June is about 61 percent. Also, the mean wind speed in June is 260 miles per day. Therefore, if the pan is surrounded by a green crop for a distance of 30 feet, the pan coefficient is about 0.6. Like the temperature and radiation methods, the climatic parameters used to determine k_p are average values for a region and time, not daily values each year.

Table 2-19 Pan coefficients for Class A evaporation pans for different ground cover and levels of mean relative humidity and 24-hour wind run

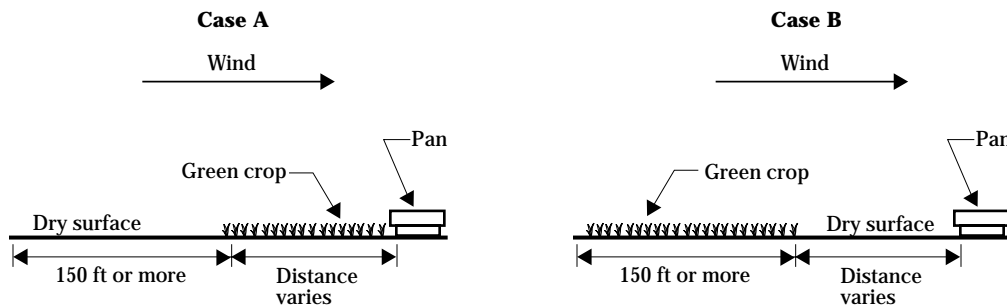

Class A pan	Case A -- pan surrounded by short green crop --			Case B ^{1/} --- pan surrounded by dry-fallow land ---				
	Low <40	Medium 40-70	High >70	Low <40	Medium 40-70	High >70		
Average daily wind run (mi/d)	Upwind distance of green crop (ft)			Upwind distance of dry fallow (ft)				
Light 120	0	0.55	0.65	0.75	0	0.7	0.8	0.85
	30	0.65	0.75	0.85	30	0.6	0.7	0.8
	300	0.7	0.8	0.85	300	0.55	0.65	0.75
	3,000	0.75	0.85	0.85	3,000	0.5	0.6	0.7
Moderate 120-240	0	0.5	0.6	0.65	0	0.65	0.75	0.8
	30	0.6	0.7	0.75	30	0.55	0.65	0.7
	300	0.65	0.75	0.8	300	0.5	0.6	0.65
	3,000	0.7	0.8	0.8	3,000	0.45	0.55	0.6
Strong 240-480	0	0.45	0.5	0.60	0	0.6	0.65	0.7
	30	0.55	0.6	0.65	30	0.5	0.55	0.65
	300	0.6	0.65	0.7	300	0.45	0.50	0.6
	3,000	0.65	0.7	0.75	3,000	0.4	0.45	0.55
Very strong >480	0	0.4	0.45	0.5	0	0.5	0.6	0.65
	30	0.45	0.55	0.6	30	0.45	0.5	0.55
	300	0.5	0.6	0.65	300	0.4	0.45	0.5
	3000	0.55	0.6	0.65	3000	0.35	0.4	0.45

Adapted from J. Doorenbos and W.O. Pruitt (1977).

1/ For extensive areas of bare-fallow soils and areas without agricultural development, reduce k_p values by 20 percent under hot, windy conditions; by 5 to 10 percent for moderate wind, temperature, and humidity conditions.

Note: These coefficients are used to estimate the evapotranspiration for a clipped grass reference crop. Crop coefficients as discussed in 623.0204 are required to predict actual crop evapotranspiration rates.

Locally calibrated pan coefficients can also be determined by correlating pan evaporation to ET_o predicted from other methods. This process is often required for long-term studies where adequate climatic data as required for the Penman-Monteith method are available for only a part of the duration of the study. If evaporation pan data are available for the duration of the study, then the climatic data can be used with the Penman-Monteith method to predict ET_o values. Then the predicted ET_o values can be used to compute a pan coefficient for the specific pan. Sometimes this procedure is used to compute monthly pan coefficients. Example 2-14 illustrates the calibration procedure.

Evaporation pans have been used extensively to predict ET_o and for irrigation management. They are simple to install and use. However, the pans require careful maintenance. The conditions surrounding the

pan must be carefully managed to prevent drift in the pan coefficient.

One disadvantage of the evaporation pan is that the water in the pan stores and releases energy differently than crop surfaces. When the air temperature changes, it takes longer for the water to change temperature. Therefore, the energy that would normally be used for ET_o is used to heat water. Conversely, as air cools, there is a lag in the time required to cool the water. The result of this energy storage is that the evaporation rate from the pan generally has a narrower range of daily rates of crop water use. Over long periods, the daily rate of energy storage is small compared to the energy used during the period to evaporate water. Thus, evaporation pans are usually accurate for periods longer than 10 days. If daily rates or short period estimates are needed, the evaporation pan is not recommended.

Figure 2-18 Plot of pan evaporation against Penman-Monteith ET_o to determine a pan coefficient

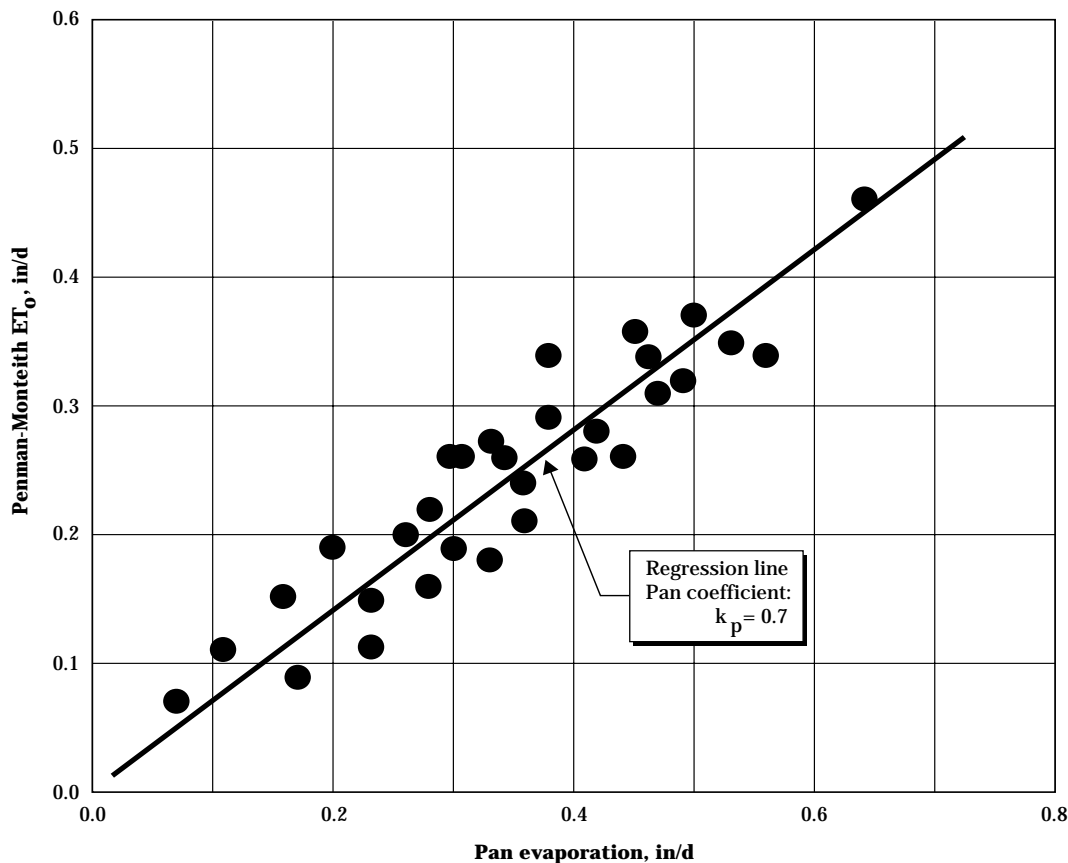

(f) Summary

Several factors affect the selection of the proper ET_o method for a specific application. Personal judgment is required for each application. If results of an application carry high risks preliminary investigation comparing alternative methods may be warranted. The four methods in this section present alternatives that will satisfy most applications.

Example 2-14 Local calibration of a pan coefficient

Required: Determine a locally calibrated pan coefficient for the Penman-Monteith ET_o and evaporation pan data given below.

Given: The following daily values have been obtained for July at a site.

Day of month	Penman-Monteith ET_o values (in/d)	Pan evaporation (in/d)	Day of month	Penman-Monteith ET_o values (in/d)	Pan evaporation (in/d)
1	0.26	0.30	16	0.46	0.64
2	0.31	0.47	17	0.34	0.56
3	0.37	0.50	18	0.35	0.53
4	0.29	0.38	19	0.18	0.33
5	0.20	0.26	20	0.15	0.16
6	0.19	0.20	21	0.11	0.11
7	0.19	0.30	22	0.22	0.28
8	0.15	0.23	23	0.26	0.31
9	0.09	0.17	24	0.26	0.41
10	0.21	0.36	25	0.28	0.42
11	0.26	0.44	26	0.32	0.49
12	0.34	0.46	27	0.36	0.45
13	0.27	0.33	28	0.34	0.38
14	0.16	0.28	29	0.26	0.34
15	0.11	0.23	30	0.24	0.36
			31	0.07	0.07

Solution: Plot the evaporation pan data on the abscissa and the Penman-Monteith data on the ordinate as shown in figure 2-18.

Use graphical or linear regression techniques to determine the slope of a line that passes through the origin of the graph. The slope of the line equals the locally calibrated crop coefficient.

In this case the value of the pan coefficient $k_p = 0.7$.

623.0204 Crop coefficients

Evapotranspiration from a cropped field is composed of transpiration from the crop and evaporation from the soil. The rate of evapotranspiration from the crop (ET_c) depends on the type of crop, stage of growth, moisture content of the surface soil, and the amount of energy available to evaporate water. The reference crop evapotranspiration rate (ET_o) is used to represent a baseline rate of evapotranspiration for a clipped grass. The evapotranspiration for other crops is computed relative to the reference crop evapotranspiration. The factor that relates actual crop water use to reference crop evapotranspiration is called the crop coefficient (K_c). This section provides data to compute crop coefficients for many types of crops. It details how to adjust the crop coefficient for water stress, for increased evaporation from the soil following rain or irrigation, and for variations in the rate of crop growth.

(a) Fundamental concepts

Crop water use (ET_c) is computed using the reference crop evapotranspiration (ET_o) and a crop coefficient (K_c):

$$ET_c = K_c ET_o \quad [2-55]$$

The value of the crop coefficient depends on several factors.

(1) Factors affecting crop coefficients

The crop coefficient depends on the growth and development of the crop canopy. The leaf area index (LAI) has been used to describe the development of the crop canopy. The LAI is the ratio of the amount of leaf area relative to the underlying land area. For example, if the total surface area of one side of the leaves is 2,600 square inches for a 3-foot square area of a field (i.e., 1,296 in²), then the LAI is about 2. As the crop grows, the LAI increases from zero to a maximum value. The maximum LAI for irrigated corn may reach as high as 5.0 depending on the variety and location of the field. An example of the change of LAI during the year is illustrated in the lower part of figure 2-19.

The pattern of the crop coefficient closely follows the shape of the LAI curve during the season (fig. 2-19). Early in the growing season, the crop coefficient is small for an annual crop. As the crop emerges and starts to grow, transpiration begins to make up a larger part of daily water use, thus the crop coefficient increases with canopy development. At some point the canopy develops sufficiently so that the crop coefficient reaches a maximum value. This time is referred to as the effective cover date. After effective cover, the crop coefficient is generally constant for a period of time even though the plant canopy continues to increase. The crop coefficient decreases as the crop matures and leaves begin to senesce. For crops that are harvested before senescence, the crop coefficient may remain at the peak value until harvest.

Where the plant canopy is small, the soil surface is not completely shaded and evaporation from a wet soil can contribute significantly to evapotranspiration. Where the soil surface is dry, the rate of evaporation from the soil is small. However, following a rain or irrigation, the wet soil surface provides for an increased evaporation rate. Therefore, the crop coefficient increases immediately following a rain or irrigation because of evaporation from the wet soil. As the soil dries, the crop coefficient decreases back to the rate for a dry soil surface. As the canopy expands, the crop shades the soil and absorbs energy that earlier would have been used to evaporate water from the soil. The increase in the crop coefficient resulting from wet soil surface evaporation therefore decreases as the canopy develops.

Where crops are stressed because of a lack of water, the evapotranspiration rate decreases. Processes involved in reducing evapotranspiration are very complex. For computing irrigation water requirements, the effect on ET_c can be accounted for by a decrease in the crop coefficient. The effect of the factors influencing the crop coefficient is illustrated for a hypothetical crop in figure 2-19.

Figure 2-19 Generalized basal crop coefficient showing the effects of surface wetness, water stress, and leaf area index during the growing season

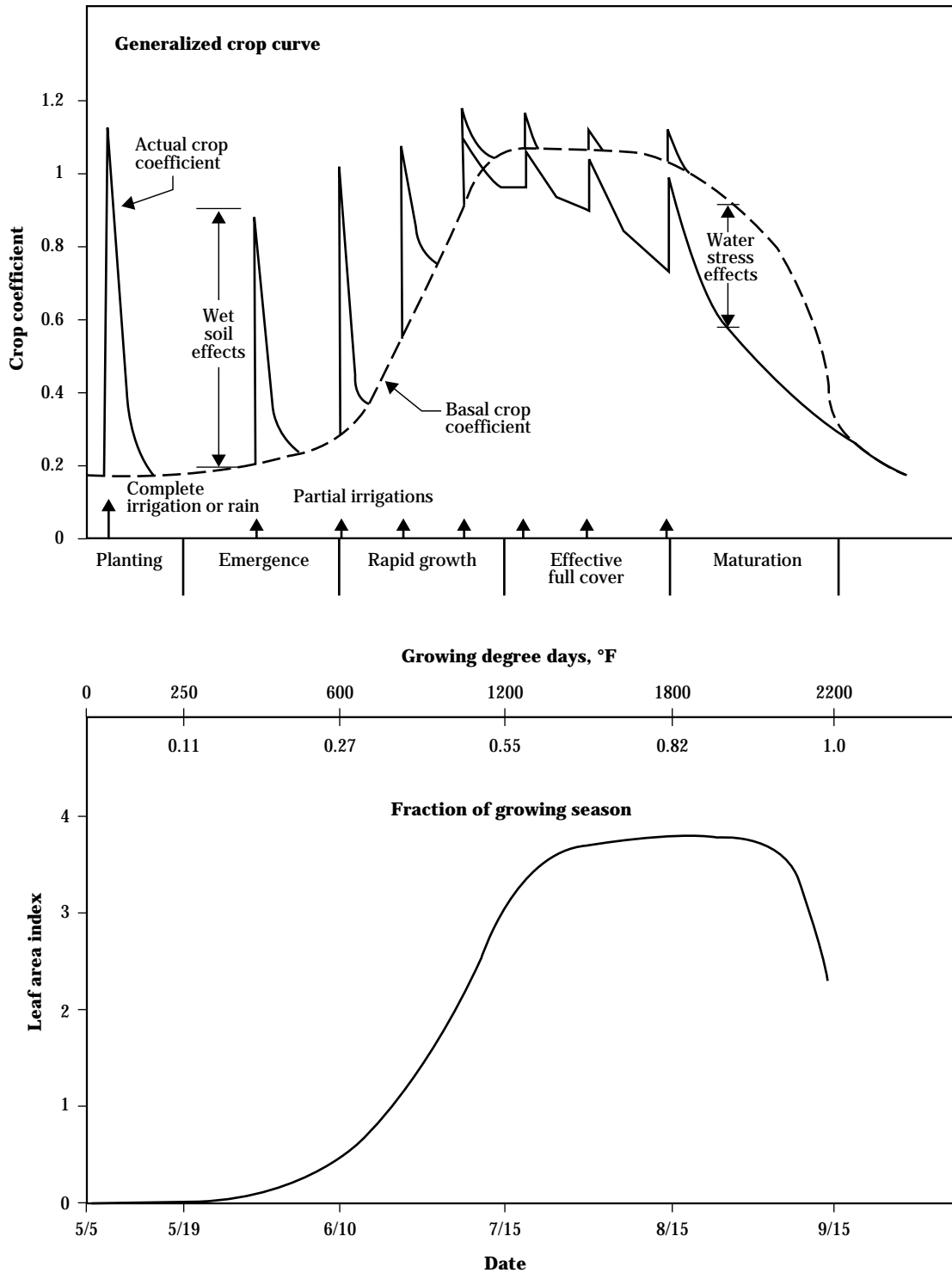

To account for the factors influencing ET_c , the generalized crop coefficient in equation 2-55 can be modified to account for water stress and evaporation from a wet soil surface. The combined expression is given as:

$$ET_c = (K_{cb} K_s + K_w) ET_o \quad [2-56]$$

where:

- ET_c = actual crop evapotranspiration rate
- K_{cb} = basal crop coefficient
- K_s = stress factor to reduce water use for stressed crops
- K_w = factor to account for increased evaporation from wet soils following rain or irrigation
- ET_o = evapotranspiration rate for a clipped grass reference crop

The basal crop coefficient (K_{cb}) in equation 2-56 applies for a healthy crop that does not suffer water stress and where the soil surface is dry. The K_s and K_w parameters are used to adjust for water stress and wet soil evaporation in a specific field for a given day. Methods to compute the basal crop coefficient are presented in 623.0204(b). Methods to determine the adjustment factors are presented in 623.0204(c) and 623.0204(d).

(2) Methods to describe canopy development

The crop coefficient depends on how the crop canopy develops. To compute the value of the crop coefficient, a method is needed to describe the rate of canopy development. Because every year is different, the rate of crop growth varies even for the same planting date. Thus for real-time applications, such as irrigation scheduling, methods are also needed to ensure that the predicted rate of canopy development is accurate.

Computing the crop coefficient requires the use of an independent variable to describe the rate of canopy development. The two most commonly used independent variables are the elapsed time (days) since planting and the cumulative growing degree days (sometimes called heat units) since planting. The elapsed time since planting is easier to use as the basis for crop coefficient computations. However, some of the annual variation of canopy development can be accounted for using growing degree days (heat units).

Stegman (1988) suggested the following definition for growing degree days:

$$GDD_n = \sum_{i=1}^n (T_{ai} - T_{base}) \quad [2-57]$$

where:

- GDD = cumulative growing degree days on the n^{th} day after planting
- n = total number of days since planting
- T_{ai} = average air temperature on day i ($^{\circ}\text{F}$)
- T_{base} = base temperature at which crop photosynthesis and growth begin

The average temperature is computed as:

$$T_{ai} = \left(\frac{T_{\max} + T_{\min}}{2} \right)_i$$

where:

- T_{\max} and T_{\min} = maximum and minimum air temperature on the i^{th} day after planting

The base temperature for computing growing degree days depends on the crop species. For example, the base temperature for some warm weather crops, such as corn, is typically 50°F and 40°F for some cool season crops, such as wheat and barley. Because of local variations the base temperature for specific crops in a given location should be determined from regional information.

The length of the growing season for a crop depends on the location and crop variety. A method is needed to characterize the relationship between crop development and either the elapsed time or the cumulative growing degree days since planting. The fraction of the growing season procedure of Stegman (1988) can be used to normalize the length of the crop growing season. Stegman defined the fraction of the growing season for a day to be the ratio of the elapsed time (or growing degree days) since planting for the day to the amount of time (or growing degree days) required for the crop to reach maturity. For example, in figure 2-19 growing degree days were used as the independent variable to describe the crop coefficient. In the example 2,200 growing degree days after planting were needed to reach maturity. If 1,200 growing degree days had accumulated by July 15, the fraction of the growing season (F_s) on July 15 would be $1,200/2,200$ or

0.55. A different variety of the same crop might only require 2,000 growing degree days to reach maturity. Thus if planted at the same time, the fraction of the growing season on July 15 would be 0.6 for the second variety. Using the fraction of the growing season as the independent variable, a single curve can be used to describe the basal crop coefficient for a type of crop. This procedure is illustrated in 623.0204(b).

For applications where irrigation requirements are computed throughout the growing season, such as irrigation scheduling, it is necessary to determine if the predicted rate of canopy development is accurate. Crops progress through specific stages of growth as they mature. These stages are easy to observe in the field. The growth stage can be related to either the elapsed time or cumulative growing degree days since planting. By observing actual growth stages, you can adjust the amount of time or growing degree days required for maturity. This allows the irrigator to adjust the crop coefficient to match actual crop development throughout the growing season. This process is illustrated in section 623.0204(f).

Many classic references on crop growth stage provide good insight in the development of localized crop coefficients. These references are available in the libraries of Land Grant Universities and many irrigation and agronomy research scientists.

(b) Determining basal crop coefficients

The crop coefficient system developed by Doorenbos and Pruitt (1977) and modified by Howell et al. (1986), will be used in this section to estimate actual crop evapotranspiration. The crop coefficients are to be used with the grass reference crop evapotranspiration methods described in section 623.0203. The crop coefficients are basal coefficients in that they represent water use of a healthy, well-watered crop where the soil surface is dry. The fraction of the growing season method developed by Stegman (1988) will be used to describe canopy development.

To use the method of Doorenbos and Pruitt (1977), the growing season is divided into four stages:

- *Initial*—Period from planting through early growth when the soil is not, or is hardly, covered by the crop (ground cover <10%).

- *Canopy development*—Period from initial stage to the time that the crop effectively covers the soil surface (ground cover @ 70 to 80%).
- *Mid-season*—Period from full cover until the start of maturation when leaves begin to change color or senesce.
- *Maturation*—Period from end of mid-season until physiological maturity or harvest.

The progression of the basal crop coefficient during the season is illustrated in figure 2–20 for corn at the example site. During the initial stage, the primary water loss is because of evaporation from the soil. Since the basal curve represents a dry soil surface, it is constant during this period. Wright (1982) suggests that the basal crop coefficient for visually dry soil is about 0.25 for grass reference crops, which is the same value recommended by Howell, et al. (1986). Wright (1982) points out that the basal coefficient could drop to about 0.1 following tillage. However, because tillage is rare following planting and before significant plant growth, a basal crop coefficient during the initial stage will be assumed to be about 0.25.

To compute the crop coefficient during other periods of crop development, four points on the crop coefficient curve need to be defined. The first point is the fraction of the growing season where canopy development begins (point 1 in fig. 2–20). At this point, the value of K_{cb} (0.25) is known based on the assumption in the preceding paragraph, so only F_{S1} is needed.

The second point occurs when the canopy has developed adequately to provide effective cover. At this time, the basal crop coefficient reaches its peak value. Thus, for the second point (point 2 in fig. 2–20), both the peak values of K_{cb} (K_{cp}) and F_{S2} are needed.

Point 3 in figure 2–20 is the time when the crop begins to mature. The only value needed for the third point is the time (F_{S3}) because the crop coefficient at point 3 equals the peak value of the basal crop coefficient.

Two locations are shown in figure 2–20 for the fourth point. The lower location represents crops that begin to senesce before harvest. To define this point, the value of the basal crop coefficient at maturity (K_{cm}) must be known. If the crop is harvested before the plant begins to mature, the crop coefficient remains constant at the peak value until harvest (see the second location of point 4 in fig. 2–20).

The five definitions needed to compute the crop coefficient (F_{S1} , F_{S2} , F_{S3} , K_{cp} , K_{cm}) are labelled in figure 2-20. The values of the parameters in figure 2-20 are $F_{S1}=0.17$, $F_{S2}=0.45$, $F_{S3}=0.78$, $K_{cp}=1.2$, and $K_{cm}=0.6$. The procedure to compute the basal crop coefficient for any stage of growth is diagrammed in figure 2-21. Example 2-15 illustrates the use of the flow chart in figure 2-21 for the crop coefficients in figure 2-20.

Crop coefficient value depends upon prevailing climatic conditions. Evapotranspiration of tall crops is generally affected more by wind than that of short crops, such as a grass cover crop. This effect is enhanced in arid climates. Therefore, Doorenbos and Pruitt (1977) recommend that the crop coefficient be adjusted based upon wind and humidity. Four conditions are defined for that purpose:

- moderate winds (wind run < 250 mi/d)
- strong winds (wind run > 250 mi/d)

- arid or humid climates (<20% and >70% minimum relative humidity)

The humidity range by Doorenbos and Pruitt is discontinuous. Where the mean minimum humidity is more than 20 percent or less than 70 percent, the crop coefficient value can be interpolated from the given data. The climatic data used to adjust the crop coefficient are average values for a region, not daily measured values.

Crop coefficient data have been grouped according to general crop types, and representative crop coefficient data for typical conditions are presented later in this chapter. Local crop coefficients should be used where such data are available. They need to be developed using computed clipped grass ET_o as the reference. Local crop development rates should be used in all cases because large variations in crop development occur with changing climates and crop varieties.

Figure 2-20 Basal crop coefficient for corn grown for grain in a windy and arid environment

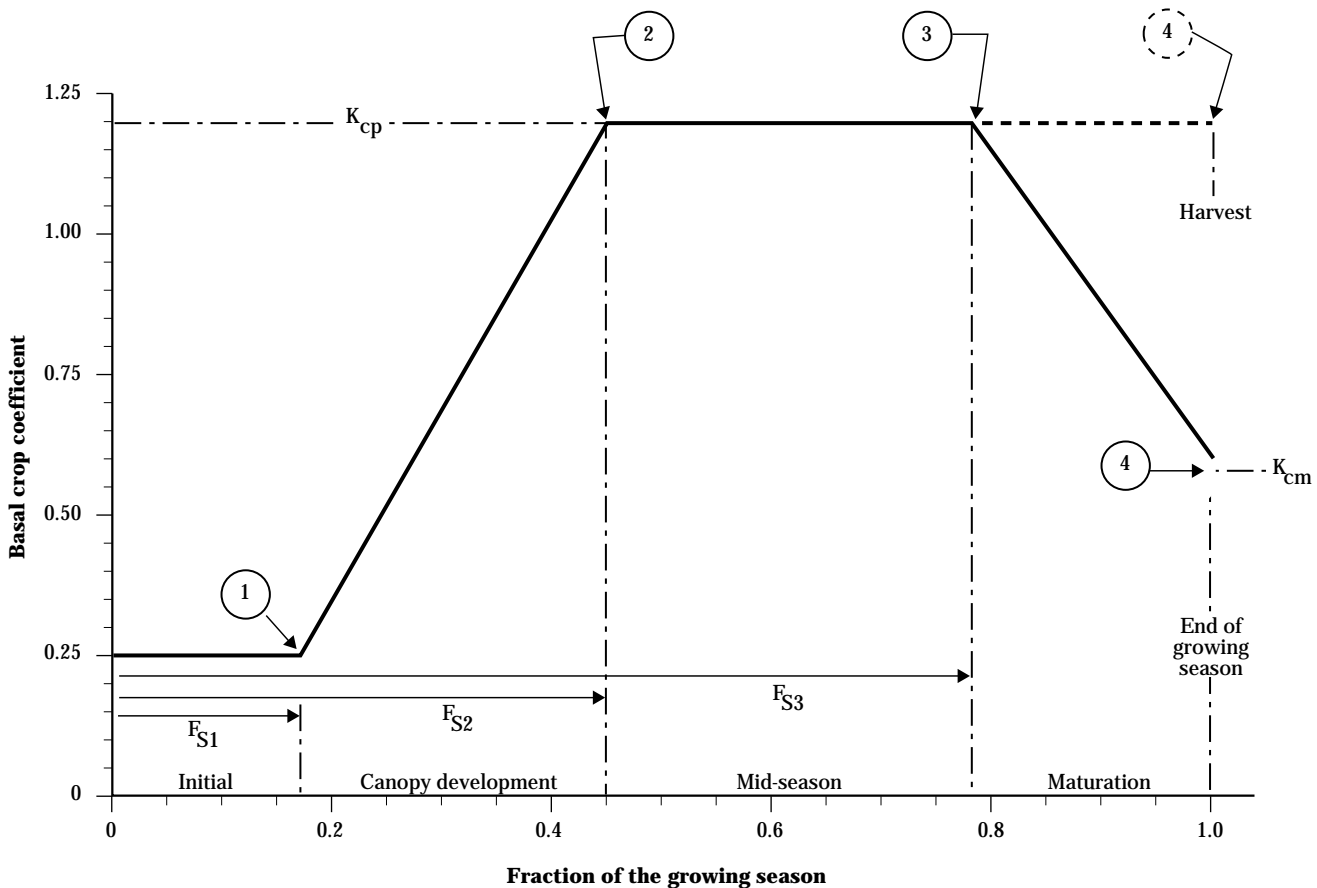

Example 2-15 Basal crop coefficient

Given: Corn grown for grain is planted on May 1 and reaches maturity on September 20. Use the crop coefficient curve given in figure 2-20.

Required: Compute the value of the basal crop coefficient on May 15, June 15, July 15, August 15, and September 15. Use the elapsed time since planting as the basis for describing canopy development.

Solution: Determine the length of the growing season from planting to maturity:

31 days in May
30 days in June
31 days in July
31 days in August
<u>20 days in September</u>
143 day growing season

Determine the fraction of growing season corresponding to each date:

Date	Elapsed time since planting	Fraction of the growing season (F_S)
May 15	15	$15/143 = 0.10$
June 15	46	$46/143 = 0.32$
July 15	76	$76/143 = 0.53$
August 15	105	$105/143 = 0.73$
September 15	138	$138/143 = 0.97$

From figure 2-20 $F_{S1}=0.17$, $F_{S2}=0.45$, $F_{S3}=0.78$, $K_{cp}=1.20$ and $K_{cm}=0.60$.

On May 15: $F_S = 0.1$, which is between 0 and F_{S1} , so $K_{cb} = 0.25$

On June 15: $F_S = 0.32$, which is between F_{S1} and F_{S2} so

$$K_{cb} = 0.25 + (K_{cp} - 0.25) \left(\frac{F_S - F_{S1}}{F_{S2} - F_{S1}} \right)$$

$$K_{cb} = 0.25 + (1.20 - 0.25) \times \left(\frac{0.32 - 0.17}{0.45 - 0.17} \right)$$

$$K_{cb} = 0.76$$

On July 15: $F_S = 0.53$, which is between F_{S2} and F_{S3} , so $K_{cb} = K_{cp} = 1.20$

On August 15: $F_S = 0.73$, which is between F_{S2} and F_{S3} , so $K_{cb} = K_{cp} = 1.20$

On September 15: $F_S = 0.97$, which is between F_{S3} and 1.0 so

$$K_{cb} = K_{cp} - (K_{cp} - K_{cm}) \left(\frac{F_S - F_{S3}}{1 - F_{S3}} \right)$$

$$K_{cb} = 1.20 - (1.20 - 0.6) \times \left(\frac{0.97 - 0.78}{1.0 - 0.78} \right)$$

$$K_{cb} = 0.68$$

Figure 2-21 Process to compute basal crop coefficients

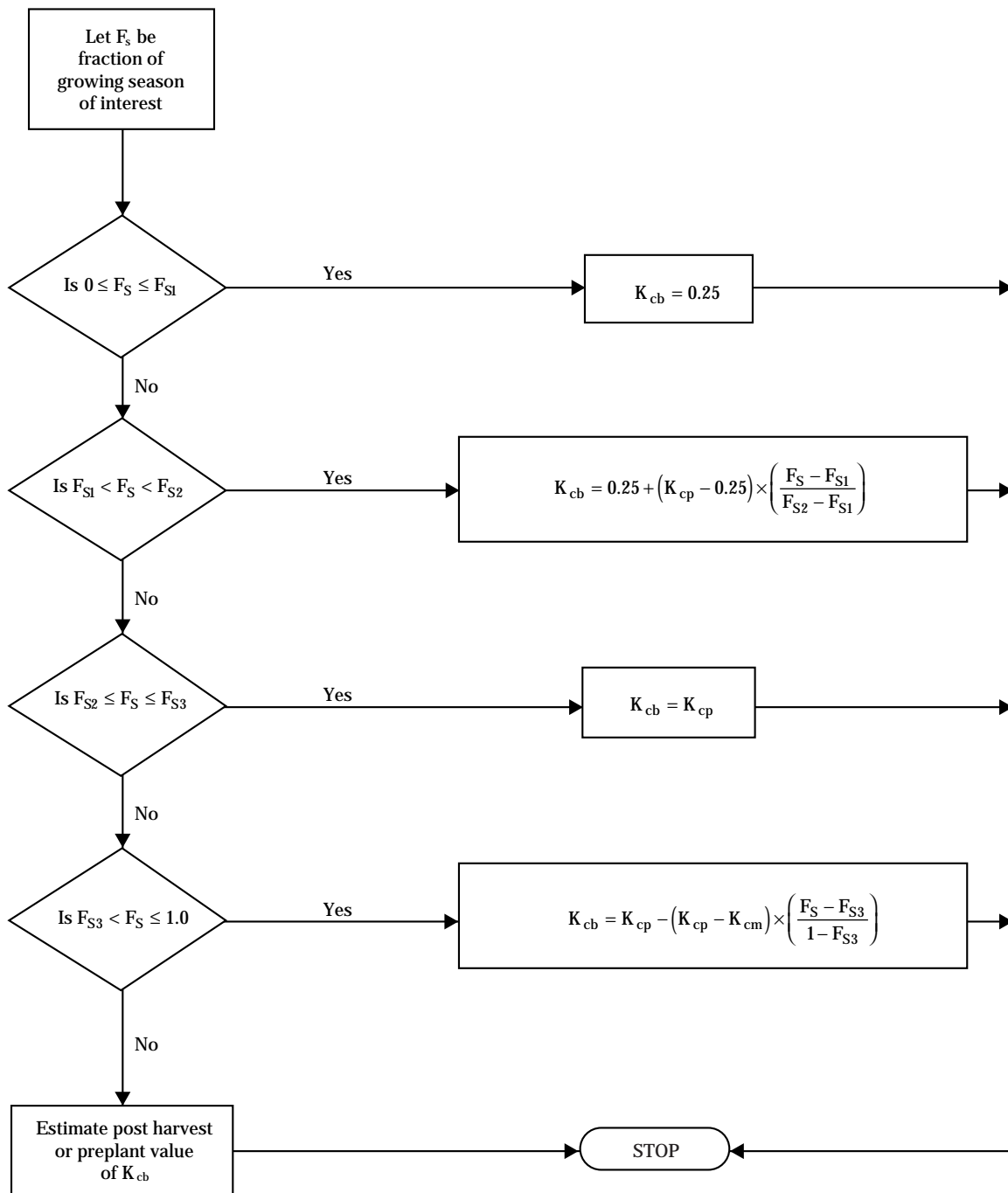

(1) Field crops

Values for the five parameters needed to compute the basal crop coefficients for field and vegetable crops are summarized in table 2-20. Doorenbos and Pruitt (1977) stress that "crop coefficient values relate to evapotranspiration of a disease-free crop grown in large fields under optimum soil water and fertility

conditions and achieving full production under the given growing environment." Crops that do not meet these provisions generally use less water unless they are raised in small fields where the effects of field boundaries can cause evapotranspiration rates to be significantly higher. Local judgment must be used.

Table 2-20 Basal crop coefficient parameters for field and vegetable crops for a grass reference crop (adapted from Doorenbos and Pruitt 1977) ^{2/}

Climatic conditions

Climate	Minimum relative humidity	Wind condition	Wind run (mi/d)
Arid	< 20 %	Moderate	< 250
Humid	> 70 %	Strong	> 250

Crop	Climate	----- Crop coefficients -----				-- Fractions of season -- for start of stages			Days from planting until maturity
		Moderate wind K _{cp}	K _{cm}	Strong wind K _{cp}	K _{cm}	F _{S1}	F _{S2}	F _{S3}	
Artichoke	Humid:	0.95	0.90	0.95	0.90	0.10	0.20	0.90	310-360
	Arid:	1.00	0.95	1.05	1.00				
Barley	Humid:	1.05	0.25	1.10	0.25	0.13	0.33	0.75	120-150
	Arid:	1.15	0.20	1.20	0.20				
Beans, green	Humid:	0.95	0.85	0.95	0.85	0.22	0.56	0.89	70-90
	Arid:	1.00	0.90	1.05	0.90				
Beans, dry	Humid:	1.05	0.30	1.10	0.30	0.16	0.42	0.80	90-110
	Arid:	1.15	0.25	1.20	0.25				
Beets, table	Humid:	1.00	0.90	1.00	0.90	0.25	0.60	0.88	70-90
	Arid:	1.05	0.95	1.10	1.00				
Carrots	Humid:	1.00	0.70	1.05	0.75	0.20	0.50	0.83	100-150
	Arid:	1.10	0.80	1.15	0.85				
Castorbeans	Humid:	1.05	0.50	1.10	0.50	0.14	0.36	0.72	160-180
	Arid:	1.15	0.50	1.20	0.50				

See footnote at end of table.

Table 2-20 Basal crop coefficient parameters for field and vegetable crops for a grass reference crop (adapted from Doorenbos and Pruitt 1977)—Continued

Crop	Climate	----- Crop coefficients -----				-- Fractions of season -- for start of stages			Days from planting until maturity
		Moderate wind K_{cp}	wind K_{cm}	Strong wind K_{cp}	wind K_{cm}	F_{S1}	F_{S2}	F_{S3}	
Celery	Humid:	1.00	0.90	1.05	0.95	0.15	0.40	0.89	120-210
	Arid:	1.10	1.00	1.15	1.05				
Corn, sweet	Humid:	1.05	0.95	1.10	1.00	0.22	0.56	0.89	80-110
	Arid:	1.15	1.05	1.20	1.10				
Corn, grain	Humid:	1.05	0.55	1.10	0.55	0.17	0.45	0.78	105-180
	Arid:	1.15	0.60	1.20	0.60				
Cotton	Humid:	1.05	0.65	1.15	0.65	0.15	0.43	0.75	180-195
	Arid:	1.20	0.65	1.25	0.70				
Crucifers: brussels, cabbage, broccoli, cauliflower	Humid:	0.95	0.80	1.00	0.85	spring planting:			80-190
	Arid:	1.05	0.90	1.10	0.95	0.18	0.63	0.89	
Cucumber: fresh market	Humid:	0.90	0.70	0.90	0.70	0.19	0.47	0.85	100-130
	Arid:	0.95	0.75	1.00	0.80				
Cucumber: mach. harvest	Humid:	0.90	0.85	0.90	0.85	0.19	0.47	0.85	90-120
	Arid:	0.95	0.95	1.00	1.00				
Eggplant	Humid:	0.95	0.80	1.00	0.85	0.22	0.54	0.84	130-140
	Arid:	1.05	0.85	1.10	0.90				
Flax	Humid:	1.00	0.25	1.05	0.25	0.15	0.36	0.75	150-220
	Arid:	1.10	0.20	1.15	0.20				
Grain, small	Humid:	1.05	0.30	1.10	0.30	0.15	0.35	0.75	150-165
	Arid:	1.15	0.25	1.20	0.25				
Lentil	Humid:	1.05	0.30	1.10	0.30	0.15	0.35	0.75	150-170
	Arid:	1.15	0.25	1.20	0.25				
Lettuce	Humid:	0.95	0.90	0.95	0.90	0.26	0.63	0.90	70-140
	Arid:	1.00	0.90	1.05	1.00				
Melons	Humid:	1.10	0.65	1.10	0.65	0.20	0.50	0.85	120-160
	Arid:	1.15	0.75	1.20	0.75				

See footnote at end of table.

Table 2-20 Basal crop coefficient parameters for field and vegetable crops for a grass reference crop (adapted from Doorenbos and Pruitt 1977)—Continued

Crop	Climate	----- Crop coefficients -----				-- Fractions of season -- for start of stages			Days from planting until maturity
		Moderate wind K _{cp}	K _{cm}	Strong wind K _{cp}	K _{cm}	F _{S1}	F _{S2}	F _{S3}	
Millet	Humid:	1.00	0.30	1.05	0.30	0.15	0.36	0.75	105-140
	Arid:	1.10	0.25	1.15	0.25				
Oats	Humid:	1.05	0.25	1.10	0.25	0.13	0.33	0.75	120-150
	Arid:	1.15	0.20	1.20	0.20				
Onion, dry	Humid:	0.95	0.75	0.95	0.75	0.10	0.26	0.75	150-210
	Arid:	1.05	0.80	1.10	0.85				
Onion, green	Humid:	0.95	0.95	0.95	0.95	0.28	0.74	0.90	70-100
	Arid:	1.00	1.00	1.05	1.05				
Peanuts	Humid:	0.95	0.55	1.00	0.55	0.20	0.46	0.80	120-140
	Arid:	1.05	0.60	1.10	0.60				
Peas	Humid:	1.05	0.95	1.10	1.00	0.20	0.47	0.85	90-110
	Arid:	1.15	1.05	1.20	1.10				
Peppers, fresh	Humid:	0.95	0.80	1.00	0.85	0.20	0.50	0.85	120-210
	Arid:	1.05	0.85	1.10	0.90				
Potato	Humid:	1.05	0.70	1.10	0.70	0.20	0.45	0.80	100-150
	Arid:	1.15	0.75	1.20	0.75				
Radishes	Humid:	0.80	0.75	0.80	0.75	0.20	0.50	0.87	30-45
	Arid:	0.85	0.80	0.90	0.85				
Safflower	Humid:	1.05	0.25	1.10	0.25	0.17	0.45	0.80	120-190
	Arid:	1.15	0.20	1.20	0.20				
Sorghum	Humid:	1.00	0.50	1.05	0.50	0.16	0.42	0.75	110-140
	Arid:	1.10	0.55	1.15	0.55				
Soybeans	Humid:	1.00	0.45	1.05	0.45	0.15	0.37	0.81	60-150
	Arid:	1.10	0.45	1.15	0.45				
Spinach	Humid:	0.95	0.90	0.95	0.09	0.20	0.50	0.90	60-100
	Arid:	1.00	0.95	1.05	1.00				
Squash, winter or pumpkin	Humid:	0.90	0.70	0.90	0.70	0.20	0.50	0.80	90-125
	Arid:	0.95	0.75	1.00	0.80				

See footnote at end of table.

Table 2-20 Basal crop coefficient parameters for field and vegetable crops for a grass reference crop (adapted from Doorenbos and Pruitt 1977)—Continued

Crop	Climate	----- Crop coefficients -----				-- Fractions of season -- for start of stages			Days from planting until maturity
		Moderate wind K_{cp}	K_{cm}	Strong wind K_{cp}	K_{cm}	F_{S1}	F_{S2}	F_{S3}	
Squash, zucchini or crookneck	Humid:	0.90	0.70	0.90	0.70	0.25	0.60	0.85	90-125
	Arid:	0.95	0.75	1.00	0.80				
Strawberry	Humid:	0.70	0.70	0.70	0.70	0.10	0.40	1.00	150-180
	Arid:	0.80	0.80	0.85	0.85				
Sugarbeet	Humid:	1.05	0.90	1.10	0.95	0.20	0.46	0.80	160-230
	Arid:	1.15	1.00	1.20	1.00				
Sunflower	Humid:	1.05	0.40	1.10	0.40	0.17	0.45	0.80	100-130
	Arid:	1.15	0.35	1.20	0.35				
Tomato	Humid:	1.05	0.85	1.10	0.85	0.20	0.50	0.80	120-180
	Arid:	1.20	0.90	1.25	0.90				
Wheat, winter	Humid:	1.05	0.25	1.10	0.25	0.13	0.33	0.75	120-150
	Arid:	1.15	0.20	1.20	0.20				
Wheat, spring	Humid:	1.05	0.55	1.10	0.55	0.13	0.53	0.75	100-140
	Arid:	1.15	0.50	1.20	0.50				

1/ For crops not included, K_{cp} , K_{cm} , F_{s1} , F_{s2} , and F_{s3} values must be developed using local technical data and resources from universities, ARS, and SCS.

(2) Grasses and forage legumes

The recommended crop coefficient for turf grass is about 0.8 and is relatively independent of cutting. The constant value applies to well-watered turf that is adaptable to the local area. No adjustment should be made for wet soil conditions for turf grass.

Basal crop coefficients and representative conditions for various grass and forage legumes are summarized in table 2-21. Crop coefficients for harvested grass and forage legumes drop at harvest and then increase as regrowth occurs. The minimum crop coefficient after cutting is denoted by the low and the maximum coefficient after effective cover represents the peak coefficient. Regrowth normally requires about half the time between harvests to reach effective cover. The first cutting of the season generally requires longer after initial crop green-up compared to regrowth after a cutting during the season. Effective cover is often reached about half way between initial growth and the first cutting.

(3) Citrus

The basal crop coefficient for citrus assumes large, mature trees and includes different tree ground cover with clean cultivation and no weed control (table 2-22). Citrus trees are often grown in dry Mediterranean-type climates. The effect of strong winds is negligible because citrus has good transpiration control. Stomatal resistance varies with humidity and temperature.

Therefore, the K_{cb} values may need to be increased by 15 to 20 percent during mid-summer in humid and cooler climates.

For young orchards with little tree ground cover, K_{cb} values assume 20 percent and 50 percent tree ground cover. With frequent rain or irrigation, values for clean cultivation will approach those for no weed control. Some studies indicate somewhat higher values, up to 10 to 15 percent for grapefruit and lemons compared with those given. Months mentioned refer to the northern hemisphere; for southern hemisphere add 6 months.

(4) Deciduous trees

The basal crop coefficients for deciduous trees are summarized in table 2-23 for various conditions. The values represent full grown trees. Adjustments should be made according to the footnotes for the table. Additionally, dates generally have a basal crop coefficient of 1.0 throughout the season.

(5) Sugarcane

Approximate basal crop coefficients for sugarcane are summarized in table 2-24. Because development rates can vary significantly, local growth rates should be used to improve predictions.

Table 2-21 Basal crop coefficients for alfalfa, clover, grass-legumes, and pastures using a grass reference crop (adapted from Doorenbos and Pruitt 1977)

Climate condition	---- Alfalfa ^{1/} ----		Grass for hay ^{2/}		- Clover and - grass-legumes		--- Pasture ^{3/} - -	
	Low	Peak	Low	Peak	Low	Peak	Low	Peak
Humid area - moderate wind	0.50	1.05	0.60	1.05	0.55	1.05	0.55	1.05
Arid area - moderate wind	0.40	1.15	0.55	1.10	0.55	1.15	0.50	1.10
Strong wind	0.30	1.25	0.50	1.15	0.55	1.20	0.50	1.15

1/ Effective cover (i.e., peak K_{cb}) is reached after half the period between harvests, or half the time from initial growth until harvest for the first cutting. For seed crops, K_{cb} equals the peak value until harvest following initial development.

2/ Grasses for hay reach peak K_{cb} values 7 to 10 days before harvest.

3/ Values assume good management. If the pasture is overgrazed, the low value of the basal crop coefficient may be similar to that for alfalfa. Regrowth rate depends on composition of seed mixture. If substantial amounts of grass are present, the peak value is reached in 7 to 10 days. If alfalfa and clover are predominant, regrowth occurs after about 15 days.

(6) Grapes

The basal crop coefficients for grapes with the specified conditions are given in table 2-25. Values can vary considerably based on management and production practices. Local information should be used to augment information in this table.

(7) Rice

Crop coefficient values for paddy rice grown in two locations in the United States mainland are given in table 2-26. No difference is assumed in crop coefficients between broadcast or sown and transplanted rice. The growing season differs according to variety. Therefore, the length of mid-season growth period should be adjusted using local information.

The coefficients given are for paddy or upland rice because recommended practices involve the maintenance of wet topsoil. During initial crop stage, K_{cb} may need to be reduced by 15 to 20 percent for upland rice.

(8) Other perennial crops

James, et al. (1982) presented monthly crop coefficient values for four additional crops raised in the Northwestern United States. The crop coefficient values listed in table 2-27 are for a grass reference crop. Use of these coefficients in other regions should be carefully evaluated.

(9) Summary

All crop coefficients should be considered approximate values. Local information should be used to best predict irrigation requirements. Local information is available for selected areas (Snyder, et al. 1987; Stegman 1988; and Wright 1982).

In many cases locally available crop coefficients may be referenced to alfalfa rather than grass. For such cases the alfalfa based coefficients must be increased to use with a grass based reference crop. The effect of crop height and different reference crops can be evaluated using the Penman-Monteith equation. However, the coefficients can be multiplied by 1.15 for an initial estimate. (See Jensen, et al. 1990.)

Where crop evapotranspiration rates are used in irrigation scheduling, a good record keeping system should be developed to monitor crop development. Several years of data will be very valuable in developing a data base for defining crop coefficients.

Table 2-22 Basal crop coefficients for citrus grown in predominantly dry areas with moderate wind using a grass reference crop (adapted from Doorenbos and Pruitt 1977)

Ground cover	Weed control	Jan	Feb	Mar	Apr	May	Jun	Jul	Aug	Sep	Oct	Nov	Dec
Large, mature trees providing 70% tree ground cover	Clean cultivated	.75	.75	.7	.7	.7	.65	.65	.65	.65	.7	.7	.7
	No weed control	.9	.9	.85	.85	.85	.85	.85	.85	.85	.85	.85	.85
Trees providing \cong 50% tree ground cover	Clean cultivated	.65	.65	.6	.6	.6	.55	.55	.55	.55	.55	.6	.6
	No weed control	.9	.9	.85	.85	.85	.85	.85	.85	.85	.85	.85	.85
Trees providing \cong 20% tree ground cover	Clean cultivated	.55	.55	.5	.5	.5	.45	.45	.45	.45	.45	.5	.5
	No weed control	1.0	1.0	.95	.95	.95	.95	.95	.95	.95	.95	.95	.95

Table 2-23 Basal crop coefficient for full grown deciduous fruit and nut trees using a grass reference crop (from Howell, et al. 1986)

	Mar	Apr	May	Jun	Jul	Aug	Sep	Oct	Nov	Mar	Apr	May	Jun	Jul	Aug	Sep	Oct	Nov	
	----- With ground cover crop ^{1/} -----									----- Clean, cultivated, weed free ^{2/} -----									
Cold winter with killing frost: Ground cover starting in April																			
Apple, cherry																			
Humid, moderate wind	—	.5	.75	1.0	1.1	1.1	1.1	1.1	.85	—	.45	.55	.75	.85	.85	.8	.6	—	—
Humid, strong wind	—	.5	.75	1.1	1.2	1.2	1.15	.9	—	—	.45	.55	.8	.9	.9	.85	.65	—	—
Arid, moderate wind	—	.45	.85	1.15	1.25	1.25	1.2	.95	—	—	.4	.6	.85	1.0	1.0	.95	.7	—	—
Arid, strong wind	—	.45	.85	1.2	1.35	1.35	1.25	1.0	—	—	.4	.65	.9	1.05	1.05	1.0	.75	—	—
Peach, apricot, pear, plum																			
Humid, moderate wind	—	.5	.7	.9	1.0	1.0	.95	.75	—	—	.45	.5	.65	.75	.75	.7	.55	—	—
Humid, strong wind	—	.5	.7	1.0	1.05	1.1	1.0	.8	—	—	.45	.55	.7	.8	.8	.75	.6	—	—
Arid, moderate wind	—	.45	.8	1.05	1.15	1.15	1.1	.85	—	—	.4	.55	.75	.9	.9	.7	.65	—	—
Arid, strong wind	—	.45	.8	1.1	1.2	1.2	1.15	.9	—	—	.4	.6	.8	.95	.95	.9	.65	—	—
Cold winter with light frost: No dormancy in grass cover crops																			
Apple, cherry, walnut ^{3/}																			
Humid, moderate wind	.8	.9	1.0	1.1	1.1	1.1	1.05	.85	.8	.6	.7	.8	.85	.85	.8	.8	.75	.65	
Humid, strong wind	.8	.95	1.1	1.15	1.2	1.2	1.15	.9	.8	.6	.75	.85	.9	.9	.85	.8	.8	.7	
Arid, moderate wind	.85	1.0	1.15	1.25	1.25	1.2	.95	.85	.85	.5	.75	.95	1.0	1.0	.95	.9	.85	.7	
Arid, strong wind	.85	1.05	1.2	1.35	1.35	1.25	1.0	.85	.85	.5	.8	1.0	1.05	1.05	1.0	.95	.9	.75	
Peach, apricot, pear, plum, almond, pecan																			
Humid, moderate wind	.8	.85	.9	1.0	1.0	1.0	.95	.8	.8	.55	.7	.75	.8	.8	.7	.7	.65	.55	
Humid, strong wind	.8	.9	.95	1.0	1.1	1.1	1.0	.85	.8	.55	.7	.75	.8	.8	.8	.75	.7	.6	
Arid, moderate wind	.85	.95	1.05	1.15	1.15	1.15	1.1	.9	.85	.5	.7	.85	.9	.9	.9	.8	.75	.65	
Arid, strong wind	.85	1.0	1.1	1.2	1.2	1.2	1.15	.95	.85	.5	.75	.9	.95	.95	.95	.85	.8	.7	

1/ For young orchards with tree ground cover of 20 and 50 percent, reduce mid-season K_{cb} values by 10 to 15 percent and 5 to 10 percent, respectively.2/ For young orchards with tree ground cover of 20 and 50 percent, reduce mid-season K_{cb} values by 25 to 35 percent and 10 to 15 percent, respectively.

3/ For walnut, March through May possibly 10 to 20 percent lower values because of slower leaf growth.

Table 2-24 Basal crop coefficients for sugarcane using a grass reference crop (adapted from Howell, et al. 1986)

Crop age Months		Growth stages	Humid		Arid	
12	24		Moderate wind	Strong wind	Moderate wind	Strong wind
0-1	0-2.5	Planting to 1/4 canopy	0.55	0.60	0.40	0.45
1-2	2.5-3.5	1/4 to 1/2 canopy	0.80	0.85	0.75	0.80
2-2.5	3.5-4.5	1/2 to 3/4 canopy	0.90	0.95	0.95	1.00
2.5-4	4.5-6	3/4 to full canopy	1.00	1.10	1.10	1.20
4-10	6-17	Peak use	1.05	1.15	1.25	1.30
10-11	17-22	Early senescence	0.80	0.85	0.95	1.05
11-12	22-24	Ripening	0.60	0.65	0.70	0.75

Table 2-25 Basal crop coefficients for grapes with clean cultivation, infrequent irrigation, and dry soil surface most of the season using a grass reference crop (adapted from Howell, et al. 1986)

Conditions ^{1/}	Mar	Apr	May	Jun	Jul	Aug	Sep	Oct	Nov
Mature grapes grown in areas of killing frost, initial leaves early May, harvest mid-September, ground cover 40 to 50 percent at mid-season									
1	---	---	0.50	0.65	0.75	0.80	0.75	0.65	---
2	---	---	0.50	0.70	0.80	0.85	0.80	0.70	---
3	---	---	0.45	0.70	0.85	0.90	0.80	0.70	---
4	---	---	0.50	0.75	0.90	0.95	0.90	0.75	---
Mature grapes grown in areas of only light frost, initial leaves early April, harvest late August to early September, ground cover 30 to 35 percent at mid-season									
1	---	0.50	0.55	0.60	0.60	0.60	0.60	0.50	0.40
2	---	0.50	0.55	0.65	0.65	0.65	0.65	0.55	0.40
3	---	0.45	0.60	0.70	0.70	0.70	0.70	0.60	0.35
4	---	0.45	0.65	0.75	0.75	0.75	0.75	0.65	0.35
Mature grapes grown in hot dry areas, initial leaves late February to early March, harvest late half of July, ground cover 30 to 35 percent at mid-season ^{2/}									
3	0.25	0.45	0.60	0.70	0.70	0.65	0.55	0.45	0.35
4	0.25	0.45	0.65	0.75	0.75	0.70	0.55	0.45	0.35

- 1/ 1—humid, moderate wind
 2—humid, strong wind
 3—arid, moderate wind
 4—arid, strong wind

2/ The K_{cb} values for the last two growing conditions must be reduced if ground cover is less than 35 percent.

Table 2-26 Crop coefficients for paddy rice grown in the United States mainland using a grass reference crop (adapted from Doorenbos and Pruitt 1977)

	Planting	Harvest	First & second month	Mid-season	Last four weeks
Wet summer (South)					
Moderate wind	May	September–	1.1	1.1	.95
Strong wind		October	1.15	1.15	1.0
Dry summer (California)					
Moderate wind	Early	Early	1.1	1.25	1.0
Strong wind	May	October	1.15	1.35	1.05

Table 2-27 Monthly crop coefficients for some perennial crops raised in Northwestern United States (values are adapted from James, et al. 1982)

Crop	----- Monthly crop coefficient -----							
	Jan–Apr	May	June	July	Aug	Sept	Oct	Nov–Dec
Hops	0.50	0.50	0.85	0.95	1.50	0.25	0.25	0.25
Mint	0.50	0.50	0.60	1.10	1.20	1.20	1.10	0.50
Raspberries	0.40	1.05	1.20	1.20	1.15	0.85	0.50	0.40
Strawberries	0.40	0.40	0.50	0.30	0.40	0.40	0.40	0.40

(c) Water stress factor

The water use by stressed crops is very complex and requires extensive information to predict. Irrigation systems are generally designed and operated to prevent stress, so the effects of stress generally are not too significant. If management or water supply limitations restrict irrigation, the effect of stress should be considered. The quality of some crops is also improved by controlled stress. In these cases, the computation of the water use is critical to ensure quality and to minimize yield reduction.

The effect of water stress on the rate of evapotranspiration can be described using the stress factor K_s , which is based on soil-water content (fig. 2-22). One method is the linear function used by Hanks (1974) and Ritchie (1973). With this method the stress factor is based on the percentage of the total available soil water that is stored in the crop root zone. The total available soil water (TAW) is the amount of water a soil can hold between the field capacity and permanent wilting point water contents. It is calculated as:

$$TAW = R_d \frac{\theta_{fc} - \theta_{pwp}}{100} \quad [2-58]$$

where:

- TAW = total available water (in)
- θ_{fc} = volumetric water content at field capacity (%)
- θ_{pwp} = volumetric water content at the permanent wilting point (%)
- R_d = root zone depth (in)

The available water stored in the root zone is computed as:

$$AW = R_d \frac{\theta_v - \theta_{pwp}}{100} \quad [2-59]$$

where:

- AW = available soil water (in)
- θ_v = current volumetric water content (%)

The percent of the total available water that is stored in the root zone equals

$$ASW = \frac{AW}{TAW} 100 \quad [2-60]$$

Using these definitions the stress factor K_s can be computed as:

$$K_s = \frac{ASW}{ASW_c} \quad \text{for } ASW < ASW_c$$

$$= 1.0 \quad ASW \geq ASW_c \quad [2-61]$$

The critical value of ASW varies depending on the drought tolerance of the crop (fig. 2-22). Crops that maintain ET_c under dry soil conditions, termed drought tolerant crops, and an average value of $ASW_c = 25\%$ can be used. For crops that are sensitive to drought the value of ASW_c should be about 50 percent. Example 2-16 illustrates the use of the stress factor in computing ET_c .

Irrigation water requirements generally are needed for conditions where the economic optimal yield is often near the maximum yield. Accordingly, irrigation management usually results in little water stress. For these conditions the stress factor has little effect on evapotranspiration predictions, and either form of equation for the stress factor is acceptable. If deficit irrigation is important, describing the effect of water stress on evapotranspiration becomes more critical. For most applications, the methods presented in figure 2-22 will be acceptable.

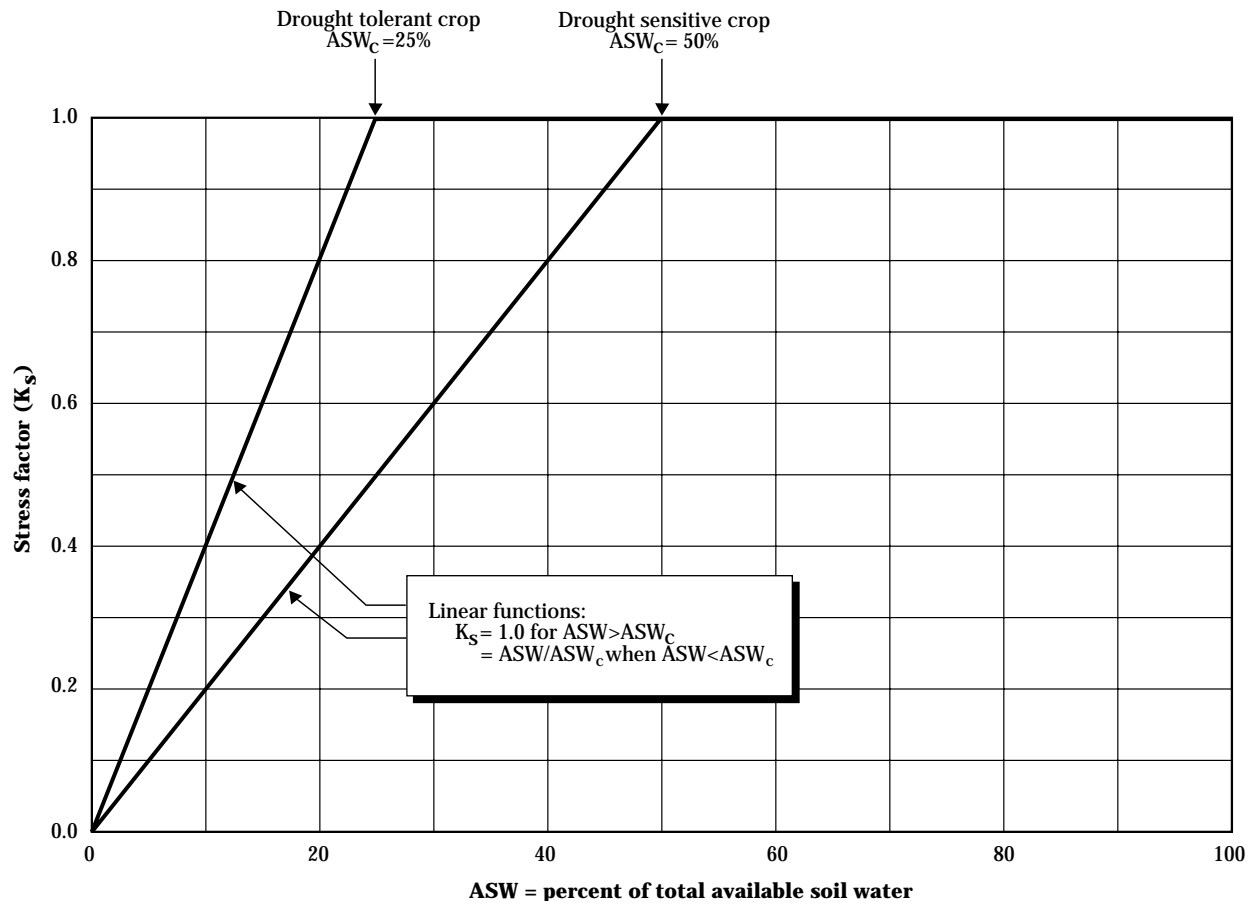
Figure 2-22 Functions used to reduce evapotranspiration based on soil-water content

Example 2-16 Water stress factor

Given: The volumetric water content at field capacity and the permanent wilting point are 25 and 10 percent, respectively. Soil water was measured in two fields with the following results:

Field A: Available water in the root zone = 2 inches

Field B: Available water in the root zone = 5 inches

The crop root zone is 4 feet deep in both fields. The reference crop evapotranspiration rate is 0.3 inch per day, and the basal crop coefficient is 1.1 at this time of year.

Required: Compute the evapotranspiration rate for a drought-tolerant and drought-sensitive crop in each field.

Solution: 1. Compute the total available water in the 4-foot root zone.

$$\text{TAW} = 48 \text{ in} \times \frac{(25 - 10)}{100} = 7.2 \text{ in}$$

2. Compute ASW for each field.

$$\text{Field A: ASW} = \left(\frac{2}{7.2} \right) \times 100 = 28\%$$

$$\text{Field B: ASW} = \left(\frac{5}{7.2} \right) \times 100 = 69\%$$

3. Compute the ET_c for a drought-tolerant crop on each field. For this case $ASW_c = 25\%$

Because $ASW > ASW_c$ for both Field A and B, the value of $K_s = 1.0$ for both fields.

The evapotranspiration rate is then

$$ET_c = K_{cb} K_s ET_o = 1.1 \times 1.0 \times 0.3 = 0.33 \text{ in / d}$$

4. Compute the ET_c for the drought-sensitive crop on both fields.

For drought-sensitive crops, the value of $ASW_c = 50$ percent; thus the value of the stress factor for each field is:

Field A: ASW = 28%, which is less than ASW_c — so

$$K_s = \frac{ASW}{ASW_c} = \frac{28\%}{50\%} = 0.56$$

$$ET_c = K_{cb} K_s ET_o = 1.1 \times 0.56 \times 0.33 = 0.18 \text{ in / d}$$

Field B: ASW = 69%, which is more than ASW_c — so

$K_s = 1.0$, and the value for ET_c is the same as that for the drought-tolerant crop = 0.33 in/d.

(d) Wet soil evaporation

The increased rate of evaporation because of a wet soil surface is influenced by the amount of canopy development, the energy available to evaporate water and the hydraulic properties of the soil. One of the most widely cited methods to predict this effect is by Ritchie (1972). That method depends on knowing the leaf area index of the crop and soil parameters that are not readily available. Therefore, such models have not been widely used to estimate irrigation requirements. Instead, simpler methods have been developed.

The wet soil evaporation factor (K_w) was described by Wright (1981) using a relationship similar to:

$$K_w = F_w(1 - K_{cb})f(t) \quad [2-62]$$

where:

F_w = the fraction of the soil surface wetted
 $f(t)$ = wet soil surface evaporation decay function

$$= 1 - \sqrt{\frac{t}{t_d}}$$

t = elapsed time since wetting, days
 t_d = days required for the soil surface to dry

The wet soil surface evaporation adjustment is only used as long as the basal crop coefficient (K_{cb}) is less than one.

The fraction of the soil surface wetted depends on the amount and method of irrigation. Suggested values for various methods of watering are summarized in table 2-28. Values for F_w can be estimated for actual conditions by observing soil conditions following an irrigation.

The amount of time required for the soil surface to dry depends on the soil texture. The value of t_d also depends on the evaporative demand of the climate. When the ET_o is high, the length of time for drying will be short. During cool, cloudy, and damp periods, soil evaporation might persist longer. An approximate drying time is given in table 2-29 for six soils, and the value of the wet soil surface decay factor is also summarized. This method can easily be calibrated to local conditions by observing the drying time required for actual soil conditions.

The amount of excess evaporation from a wet soil is limited by the amount of water received by rain or irrigation. If equation 2-58 is used indiscriminately, the amount of wet soil evaporation could exceed the water received. Hill, et al. (1983) developed a term called the wet soil persistence factor (P_f) to account for this possibility. The persistence factor represents the cumulative effect of wet soil surface evaporation. The total wet soil evaporation from a wetting event (E_{ws}) can be estimated as:

$$E_{ws} = P_f F_w \left[1 - \overline{K_{cb}} \right] \overline{ET_o} \quad [2-63]$$

where:

$\overline{K_{cb}}$ = the average basal crop coefficient during the drying period

$\overline{ET_o}$ = the average daily reference crop evapotranspiration during the drying period

The maximum possible value for E_{ws} is the amount of irrigation or rain water received.

Example 2-17 helps explain the procedure for estimating the wet soil surface evaporation. This example illustrates that the persistence factor only approximates the cumulative daily evaporation because of daily variations.

Table 2-28 Fraction of the soil surface wetted for various types of irrigation

Method	F_w
Rain	1.0
Above canopy sprinklers	1.0
LEPA systems (every other row)	0.5
Borders and basin irrigation	1.0
Furrow irrigation	
Large application depth	1.0
Small application depth	0.5
Every other row irrigated	0.5
Trickle irrigation	0.25

Table 2-29 Wet soil surface evaporation decay function $f(t)$ ^{1/} and the persistence factor P_f ^{2/} for typical soils (adapted from Hill, et al. 1983)

Time since wetting (t), days ^{3/}	Clay	Clay loam	Silt loam	Sandy loam	Loamy sand	Sand
	Drying time (t_d), days					
	10	7	5	4	3	2
0	1.00	1.00	1.00	1.00	1.00	1.00
1	0.68	0.62	0.55	0.50	0.42	0.29
2	0.55	0.47	0.37	0.29	0.18	0.00
3	0.45	0.35	0.23	0.13	0.00	
4	0.37	0.24	0.11	0.00		
5	0.29	0.15	0.00			
6	0.23	0.07				
7	0.16	0.00				
8	0.11					
9	0.05					
10	0.00					
P_f	3.89	2.90	2.26	1.92	1.60	1.29

$$1/ f(t) = \text{wet soil evaporation decay function} = 1 - \sqrt{\frac{t}{t_d}}$$

$$2/ P_f = \text{wet soil persistence factor} = \sum_{t=0}^{t_d} f(t)$$

3/ $t = 0$ represents the day of wetting, and 1 is one day after wetting.

Example 2-17 Wet soil surface evaporation

Given: 0.5 inches applied with a LEPA (Low Energy Precision Application) irrigation system on day 0. Fine sandy loam soil and the following daily climatic and crop coefficient data.

Day	K_{cb}	ET_o (in/da)
0	0.40	0.25
1	0.42	0.30
2	0.44	0.28
3	0.46	0.40
4	0.48	0.35
5	0.50	0.20

Required: Determine the daily wet soil evaporation rate and the total wet soil evaporation for the event.

Solution: $K_w = F_w [1 - K_{cb}] f(t)$

Using table 2-28, $F_w = 0.5$.

Using table 2-29, the daily wet soil evaporation can be computed.
The daily $E_{ws} = K_w ET_o$

Day	$f(t)$	K_s	Daily E_{ws}
0	1.00	0.30	0.075
1	0.50	0.15	0.045
2	0.29	0.08	0.022
3	0.13	0.03	0.012
4	0.00	0.00	0.000
5	0.00	0.00	0.000
Total			0.15

The persistence factor P_f for the fine sandy loam soil is 1.92.

The cumulative wet soil evaporation can be estimated using equation 2-63:

$$E_{ws} = P_f F_w (1 - \overline{K_{cb}}) \overline{ET_c}$$

For the four days of wet soil evaporation,

$$\overline{K_{cb}} = 0.43 \text{ and } \overline{ET_o} = 0.31 \text{ in / d}$$

Thus, $E_{ws} \cong (1.92)(0.5)(1 - 0.43)(0.31) = 0.17 \text{ in}$

Since E_{ws} is ≤ 0.5 inches, results are acceptable.

(e) Average crop coefficients

A daily accounting of field conditions is impractical for some irrigation management decisions. The stress factor used in equation 2-56 requires that the soil-water content be known on a daily basis, which leads to excessive calculations when computing crop evapotranspiration for long periods. To avoid excessive calculations, an average crop coefficient for a period is generally used. The average crop coefficient must include the basal crop coefficient and the effect of wet soil evaporation. If water stress is expected, an appropriate stress factor can also be selected although this is generally not done. The average crop coefficient (K_a) is defined as:

$$\overline{K_a} = \overline{K_s K_{cb}} + \overline{K_w} \quad [2-64]$$

where:

$\overline{\quad}$ denotes the average value of each parameter over the calculation period.

To estimate the average crop coefficient, the wet soil surface evaporation must be estimated. This can be done using a rainfall recurrence interval. The recurrence interval is the average time between wetting events. For example, if the recurrence interval is 7 days, one irrigation or rain could be expected each week. The average wet soil surface factor can be estimated by:

$$\overline{K_w} = F_w \left(1 - \overline{K_{cb}} \right) A_f \quad [2-65]$$

where

A_f = the average wet soil evaporation factor that is listed in table 2-30. Using this approach, the average crop coefficient can be computed as:

$$\overline{K_a} = \overline{K_s K_{cb}} + F_w \left(1 - \overline{K_{cb}} \right) A_f \quad [2-66]$$

Example 2-18 helps illustrate the procedure.

Table 2-30 Average wet soil evaporation factor (A_f)

Recurrence interval (days)	Clay	Clay loam	Silt loam	Sandy loam	Loamy sand	Sand
1	1.000	1.000	1.000	1.000	1.000	1.000
2	0.842	0.811	0.776	0.750	0.711	0.646
3	0.746	0.696	0.640	0.598	0.535	0.431
4	0.672	0.608	0.536	0.482	0.402	0.323
5	0.611	0.535	0.450	0.385	0.321	0.259
6	0.558	0.472	0.375	0.321	0.268	0.215
7	0.511	0.415	0.322	0.275	0.229	0.185
8	0.467	0.363	0.281	0.241	0.201	0.162
9	0.427	0.323	0.250	0.214	0.178	0.144
10	0.389	0.291	0.225	0.193	0.161	0.129
11	0.354	0.264	0.205	0.175	0.146	0.118
12	0.325	0.242	0.188	0.161	0.134	0.108
13	0.300	0.224	0.173	0.148	0.124	0.099
14	0.278	0.208	0.161	0.138	0.115	0.092
15	0.260	0.194	0.150	0.128	0.107	0.086
16	0.243	0.182	0.141	0.120	0.100	0.081
17	0.229	0.171	0.132	0.113	0.094	0.076
18	0.216	0.161	0.125	0.107	0.089	0.072
19	0.205	0.153	0.118	0.101	0.085	0.068
20	0.195	0.145	0.113	0.096	0.080	0.065
21	0.185	0.138	0.107	0.092	0.076	0.062
22	0.177	0.132	0.102	0.088	0.073	0.059
23	0.169	0.126	0.098	0.084	0.070	0.056
24	0.162	0.121	0.094	0.080	0.067	0.054
25	0.156	0.116	0.090	0.077	0.064	0.052
26	0.150	0.112	0.087	0.074	0.062	0.050
27	0.144	0.108	0.083	0.071	0.059	0.048
28	0.139	0.104	0.080	0.069	0.057	0.046
29	0.134	0.100	0.078	0.066	0.055	0.045
30	0.130	0.097	0.075	0.064	0.054	0.043

where:

$$A_f = \sum_{i=0}^{R_f-1} \left(\frac{1 - \sqrt{\frac{i}{R_f}}}{R_f} \right)$$

R_f = recurrence interval of wetting days

t_d = drying time for the respective soil

i = days since wetting

Example 2-18 Average crop coefficient

Given: The basal crop coefficient for corn is shown in figure 2-20 for the example site. The soil type is sandy loam. The wetting recurrence interval is 4 days during the initial and canopy development stages and 14 days during the maturation stage. The field is irrigated with overhead sprinklers, and little crop water stress occurs.

Required: Draw the basal and average crop coefficient curves for this site if water stress is minimal.

Solution: From the available information, $F_w = 1.0$ and $K_s = 1.0$. From table 2-30 the average wet soil evaporation factor is:

Period	A_f
Initial	0.482
Canopy development	0.482
Maturation	0.138

Then select basal crop coefficients for representative fractions of the growing season and compute K_a as:

$$K_a = \overline{K_s K_{cb}} + F_w (1 - \overline{K_{cb}}) A_f$$

Fraction of growing season	A_f	K_{cb}	K_a
0.00	0.482	0.25	0.61
0.17	0.482	0.25	0.61
0.25	0.482	0.52	0.75
0.30	0.482	0.69	0.84
0.35	0.482	0.86	0.93
0.40	0.482	1.03	1.03
0.85	0.138	1.01	1.01
0.90	0.138	0.94	0.95
0.95	0.138	0.84	0.86
1.00	0.138	0.60	0.66

Note that no adjustment is made for wet soil evaporation when K_{cb} is > 1.0.

The basal and average crop coefficient curves are plotted in figure 2-23.

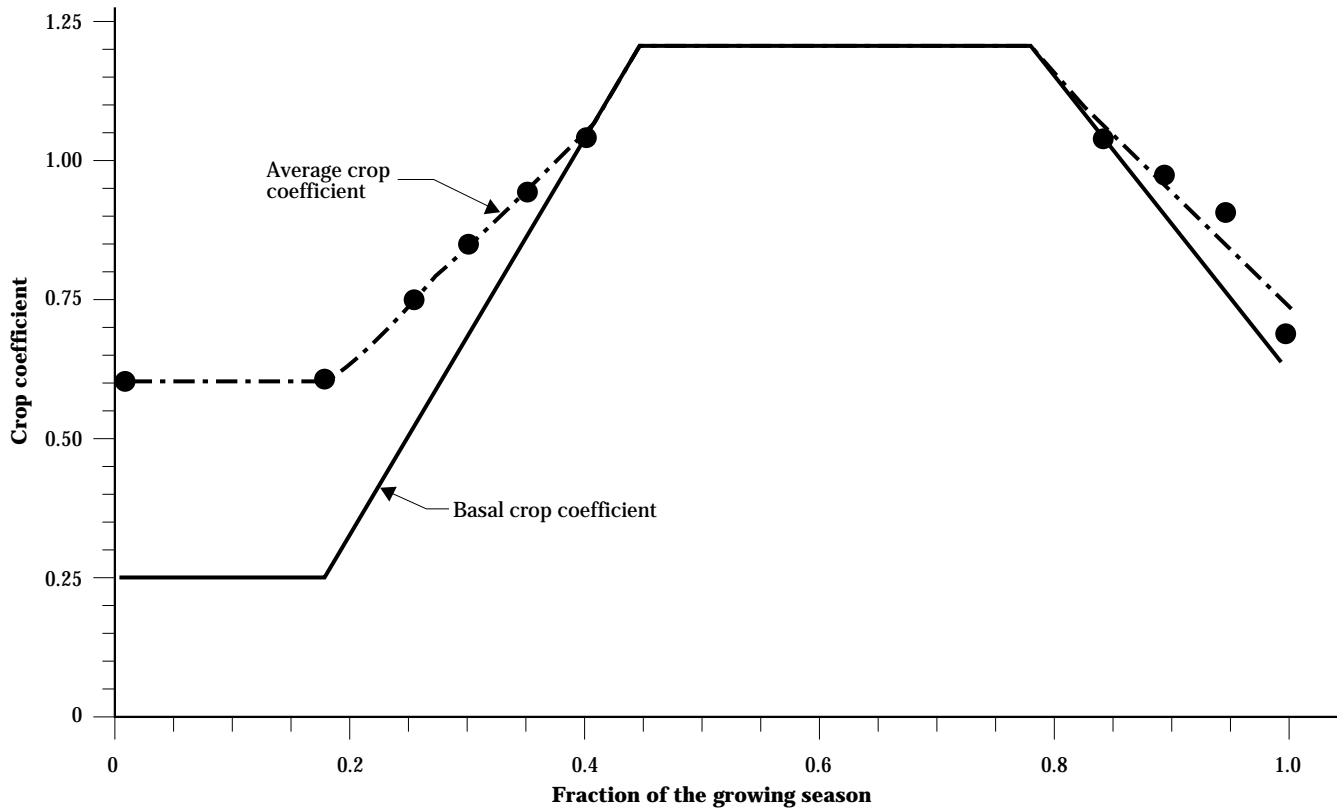
Figure 2-23 Comparison of basal and average crop coefficients for the average crop coefficient example

(f) Estimating evaporation during the nongrowing season

Sometimes it is necessary to compute water use for the time between when a crop matures, or is harvested, and when the next crop is planted. This time period is called the nongrowing season. In some locations this is a long period. For example, in the Midwest row crops generally mature in September and are harvested in September or October. The next crop is usually planted in April or May. This leaves 6 months during the fall, winter, and spring for evaporation. The evaporation of water from soils during this time can be significant for annual water budgets and water allocation considerations.

Doorenbos and Pruitt (1977) presented a method to compute an average crop coefficient for the nongrowing season. Their method depends on the frequency of rain and the reference crop evapotranspiration during the time interval of concern:

when $f_p < 4$ days: (2-67)

$$K_a = (1.286 - 0.27 f_p) \text{EXP} \left\{ \left[0.254 - 1.07 \text{LN}(f_p) \right] \text{ET}_o \right\}$$

when $f_p \geq 4$ days:

$$K_a = 2(f_p)^{-0.49} \text{EXP} \left\{ \left[-0.51 - 1.02 \text{LN}(f_p) \right] \text{ET}_o \right\}$$

where:

- K_a = average crop coefficient during the period
- f_p = interval between significant rains or irrigations (days)
- LN = natural logarithm
- ET_o = average reference crop evapotranspiration for the period (in/d)
- EXP = exponential function

Once the average crop coefficient is determined, the evaporation for the nongrowing season can be computed as with other average crop coefficients. Example 2-19 illustrates the use of equation 2-67.

The method of Doorenbos and Pruitt (1977) does not apply for all conditions. It is inappropriate for frozen or snow covered soils. Evaporation during the nongrowing season is affected by several other factors. Tillage lifts wet soils to the surface, increasing the evaporation rate for several days following the tillage.

Example 2-19 Nongrowing season crop coefficient

Given: In spring a rain occurs about once per week, and the average grass reference crop evapotranspiration is about 0.15 inches per day.

Required: Compute the expected weekly evaporation for this site.

Solution: 1. Compute the average crop coefficient for the nongrowing season:
The interval between rains is 7 days, and ET_o is 0.15 inches per day, so

$$K_a = 2(f_p)^{-0.49} \text{EXP} \left\{ \left[-0.51 - 1.02 \text{LN}(f_p) \right] \text{ET}_o \right\}$$

$$K_a = 2(7)^{-0.49} \text{EXP} \left\{ \left[-0.51 - 1.02 \text{LN}(7) \right] 0.15 \right\}$$

$$K_a = 0.53$$

2. Compute the average daily evaporation:

$$\text{ET}_c = K_a \text{ET}_o = 0.53 \times 0.15 = 0.08 \text{ in / d}$$

Thus the weekly evaporation = 0.56 inch per week

Tillage also reduces the amount of crop residue on the soil surface. Residue shades the soil surface and increases the resistance to vapor movement from the soil to the environment. However, Gardner (1983) showed that the daily evaporation rate for a residue-covered soil could exceed that from a bare soil after a long period of drying. Weeds and other factors can also substantially change evapotranspiration during the nongrowing season. Thus predictions of evaporation during the nongrowing period may need to be adjusted for special circumstances or events. Local information is needed to make the adjustment.

(g) Adjusting crop coefficients for real-time predictions

When predicting crop water use for real-time applications, such as irrigation scheduling, an irrigator is often faced with shifting the crop coefficient. The adjustment is necessary because actual climate conditions may vary from the expected weather, causing a crop to develop slower or faster than anticipated. Several aspects regarding this adjustment are presented in 623.0204.

Many attempts have been made to identify the proper set of parameters and relationships to predict the rate of crop development. However, those efforts have only been partly successful. One of the most common expressions is growing degree days, sometimes called heat units. Growing degree days can be computed in several ways. In many cases the methods are all equally effective, although each species may have unique characteristics that favor different procedures. Soybeans, for example, are photoperiod dependent.

The procedure in this part of chapter 2 centers on corn grown in the Midwestern United States. The procedure is generally applicable to other crops and conditions, but will require evaluation of species and local conditions. Some helpful references for such evaluations include Coelho and Dale (1980), Cross and Zuber (1972), Mederski et al. (1973), Ritchie et al. (1982), and Vanderlip (1972).

The growing degree day basis used in this section illustrates how to adjust the crop coefficient for corn given in equation 2-56. A base temperature of 50 °F was used for corn in the Midwest. Growing degree days were accumulated from emergence until physi-

ological maturity. For perennial crops, the first growth should be used in place of emergence.

The growth of crops generally can be divided into definable stages. Hanway (1971) and Ritchie and Hanway (1982) established such a set of stages for corn (table 2-31). Either of Hanway's systems can be used although the second method is more descriptive. Observable stages need to be defined so that an irrigator can determine the current crop condition. The stages of growth can then be related to growing degree days for a season (fig. 2-24).

The relation of crop development to growing degree days in figure 2-24 shows a very good linear relationship for a single season. In fact, a linear relationship occurs for most seasons. The problem is that the linear relationship varies from year to year and by location. The linear relationships for the same variety grown in western Nebraska for 5 years and in eastern Nebraska for 2 years are shown in figure 2-25. These results clearly show the variability of the growth rate of a single variety between years and locations. The linear relationship for each year was good, but a different line was needed for each year. The major difficulty is that the number of growing degree days needed to reach maturity varies annually ranging from 2,200 to about 2,700 for the condition depicted in figure 2-25. The variability is further enhanced for different varieties (fig. 2-26).

The stages of growth can be related to the fraction of the growing season based on growing degree days (fig. 2-27). The fraction of the growing season is computed as:

$$F_s = \frac{GDD_i}{GDD_m} \quad [2-68]$$

where:

GDD_i = cumulative growing degree days on day i
 GDD_m = cumulative growing degree days needed for maturity

For example, using data from figure 2-24, the fraction of the growing season when 1,200 GDD have accumulated would be:

$$F_s = \frac{1,200}{2,314} = 0.52$$

since 2,314 growing degree days were needed to reach maturity.

Table 2-31 Hanway's stages of growth for corn

Old stage ^{1/}	New stage ^{2/}	Identifying characteristics
0	VE	Plant emergence
1	V4	Collar of 4th leaf visible
2	V8	Collar of 8th leaf visible
3	V12	Collar of 12th leaf visible
4	V16	Collar of 16th leaf visible
5	R1	75% of silks visible
6	R2	Blister kernel stage
7	R4	Kernels at dough stage
8	R4.5	Beginning dent
9	R5.5	Full dent
10	R6	Physiological maturity (black layer)

1 From Hanway (1971).

2 From Ritchie and Hanway (1982).

Figure 2-24 Example of the relationship of growth stages of corn to cumulative growing degree days since emergence for western Nebraska (exact relationship depends on the year and cultivar)

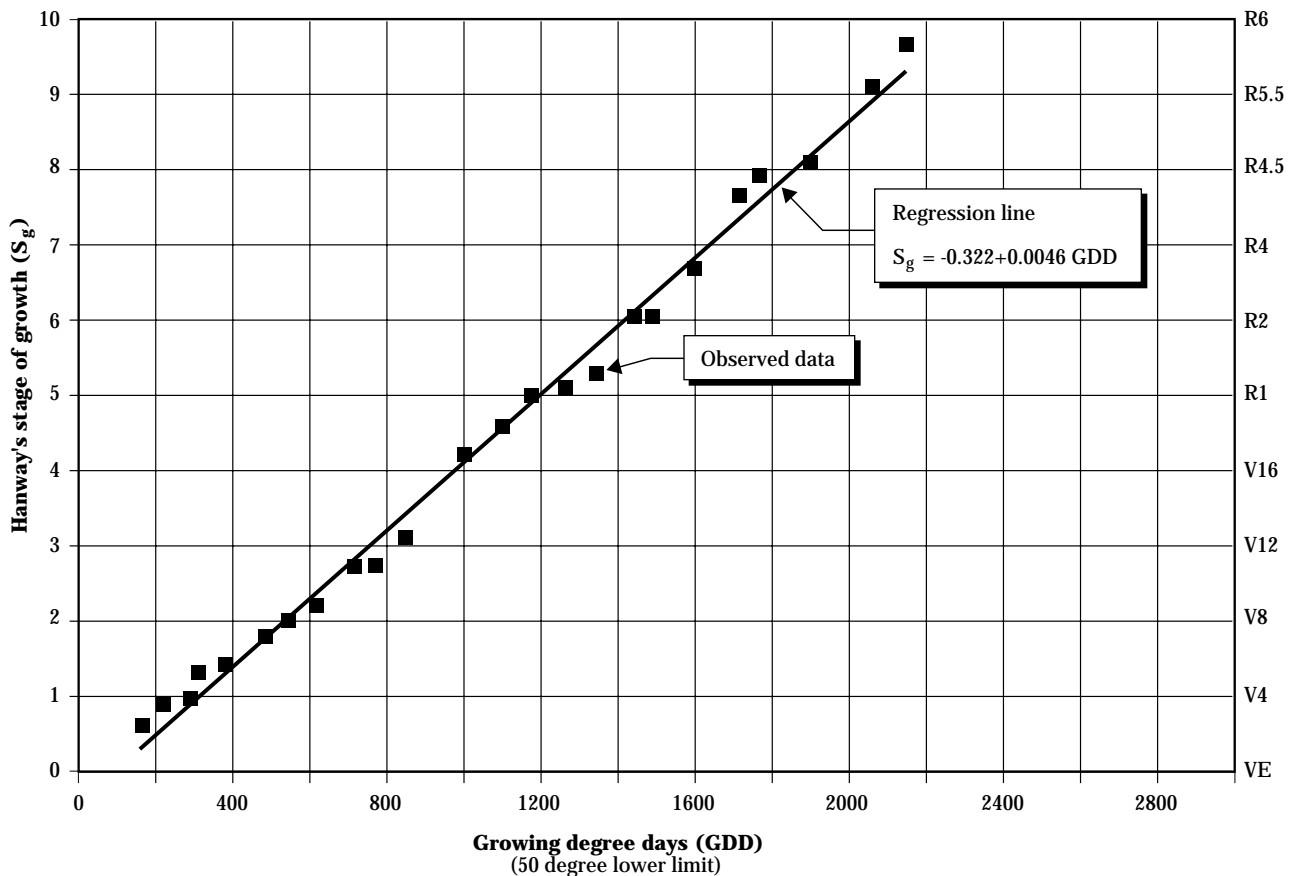

The relationship given in figure 2-27 can be used to adjust crop coefficients to reflect actual crop development. The irrigator must first determine the stage of growth for the actual crop. Then the corresponding fraction of the growing season can be determined from the relationship given in figure 2-27. These data can then be used to estimate the number of growing degree days required to reach maturity for the specific season. Example 2-20 helps illustrate the procedure.

This example illustrates that an average relationship can be used along with current observations to improve real-time crop growth predictions. Generally, the procedure will work best if several years of data are available to develop figures 2-24 and 2-27.

The procedure to adjust crop coefficients to reflect actual growth is important for real-time management, such as irrigation scheduling. Unfortunately, sufficiently accurate growth information is impossible to

provide in this publication for all crops and locations. Local information should be developed for accurate computations.

The methods developed in this section related crop growth to the fraction of growing season that has been used as the basis for the basal crop coefficient. This provides an integrated system for real-time management.

When long-term water requirements must be determined, or when planning for a system that does not already exist, the fraction of the growing season can be determined using average temperatures to compute growing degree days. Of course, for these situations, the crop curve would not be adjusted. For these situations, the growing degree days needed for maturity should be estimated based upon the expected maturity date if better information on crop development is not known.

Figure 2-25 Example of the relationship of crop development to growing degree days for Pioneer 3901 corn grown for 5 years in western Nebraska and 2 years in eastern Nebraska

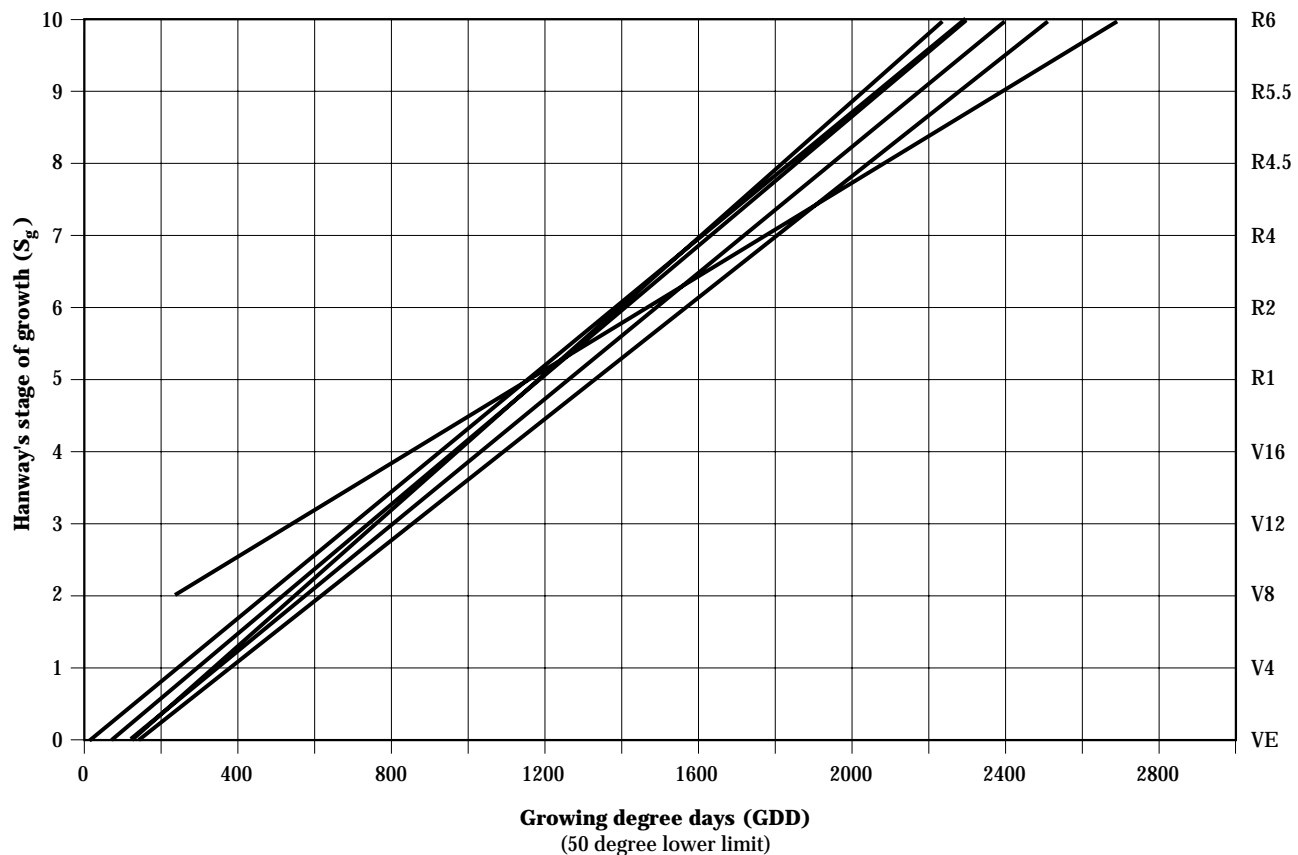

Figure 2-26 Variation of growing degree days required from emergence to maturity for six corn varieties of different maturity ratings (all varieties were grown in eastern Nebraska during the same year)

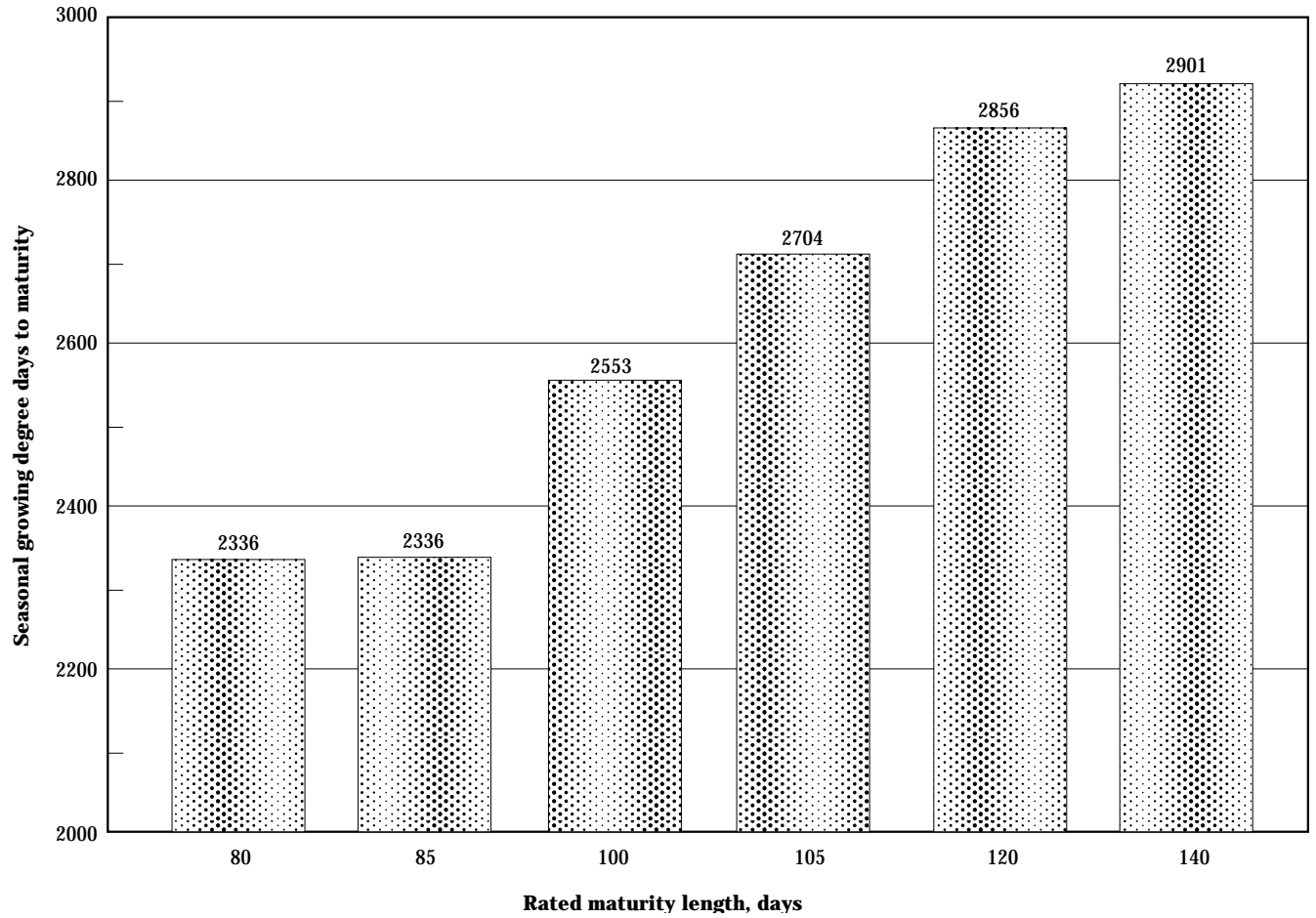
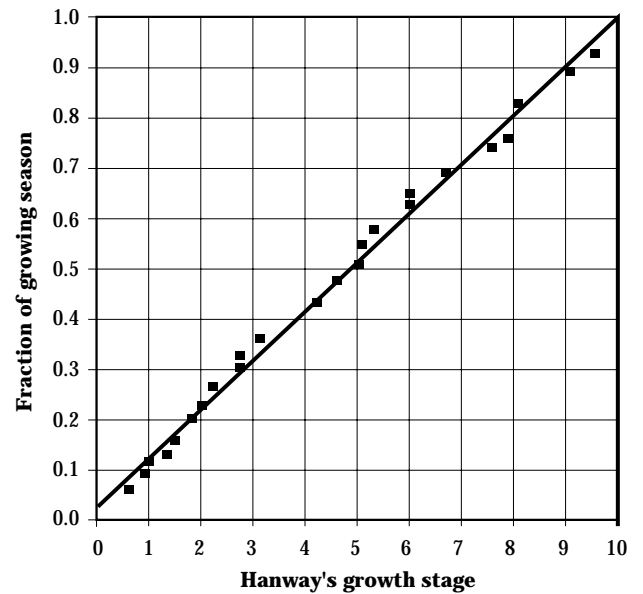

Figure 2-27 Crop growth stages for corn related to the fraction of the growing season based on growing degree days



Example 2-20 Growth adjustment

Given: An average seasonal growth and growing degree relationship as shown in figure 2-24. Suppose the actual year is similar to the year requiring 2,700 GDD to reach maturity as shown in figure 2-25. The observed growth stage in the actual year is stage V8 (i.e., #2) with an associated growing degree accumulation of 630 GDD (see fig. 2-25).

Required: 1. Develop the relationship shown in figure 2-27.
2. Compute the expected number of growing degree days required to reach maturity in the actual year.

Solution: 1. From figure 2-24, $S_g = -0.322 + 0.0046$ GDD. Compute GDD_m = growing degree days for maturity (when stage of growth = 10) for an average year.

$$10 = -0.322 + 0.0046 GDD_m$$

Then,

$$GDD_m = \frac{(10 + 0.322)}{0.0046}$$

$$GDD_m = 2,314 \text{ growing degree days}$$

The relationship for the fraction of growing season is:

$$F_S = \frac{GDD}{GDD_m} ; \text{ or } GDD = F_S GDD_m$$

Substitute part c into a and solve for F_S :

$$S_g = -0.322 + 0.0046(F_S GDD_m)$$

$$F_S = \frac{(S_g + 0.322)}{(0.0046 GDD_m)},$$

$$\text{with } GDD_m = 2,314$$

$$F_S = 0.0969 S_g + 0.031$$

2. Compute F_S for observed stage of growth: $F_S = 0.0969 (2) + 0.031 = 0.225$

Use definition of F_S to determine GDD_m :

$$F_S = \frac{GDD}{GDD_m}$$

$$GDD_m = \frac{GDD}{F_S}$$

Know $GDD = 630$ GDD for actual year

$$\text{Estimated } GDD_m = \frac{630}{0.225} = 2,800$$

(h) Sensing ground cover

Recently, various devices have been developed to measure the amount of light that penetrates through the canopy and reaches the soil surface. These devices can be used in several ways. They can estimate the current leaf area index (LAI). This is especially useful if a plant canopy has been damaged by wind, hail, or insects. The light measuring devices can also help determine when effective cover has been reached and when maturation begins. If the LAI is more than 3, the crop will have reached effective cover. This can be especially useful if plant populations or row spacings vary considerably. Phene et al. (1985) also used such a device to improve estimates of evaporation from a wet soil surface.

Various sophisticated models (Ritchie 1972 and Hsiao and Henderson 1985) are available to predict crop water use based on leaf area index and percent ground cover. The light bar instruments could allow increased use of these models. However, the models require many other data beyond LAI. Likewise, if crop water use is needed for planning or long-term purposes, the ground cover sensing techniques are not applicable. Thus, although the light measuring devices are a valuable additional tool for managing irrigation, they are not a substitute for the reference crop and crop coefficient approach presented in this publication.

(i) Summary

This section of chapter 2 presented methods to estimate the basal crop coefficients to determine irrigation water requirements, methods to evaluate the effect of water stress and evaporation from wet soil surfaces, and techniques to develop an average crop coefficient for long-term evapotranspiration estimates. Data are provided to approximate water use for many crops. However, local crop coefficient information should be used where available. In all cases local information is needed to predict the length of the growing season and the rate of crop development. The crop coefficients presented in this section are for a clipped grass reference crop. If other reference crop evapotranspiration methods are considered, it is essential that different crop coefficients be used, or the given crop coefficients should be adjusted using the Penman-Monteith method presented in section 623.0203 of this chapter.

623.0205 Leaching requirements for salinity control

(a) Significance of salinity

Most soils and irrigation water contain some soluble salts that are not beneficial for plant growth. Some contain salts that are toxic to plants and animals. Salts originate from dissolution or weathering of rocks or soil and are carried in solution with water. The most common are the saline salts of sodium, chlorine, and boron. Salts accumulate in the irrigated root zone where they are left behind as the soil water is used by the plant in transpiration or through surface evaporation.

Various units are used to describe the amount of salt present in water. The concentration is the mass of salt per unit volume of water. The concentration is expressed as parts of salt per million parts of water (ppm), or as the weight of salts (milligrams) per liter (L) of water (mg/L). The numerical value is the same for either unit (1 ppm = 1 mg/L). Some soil surveys report the concentration as a percentage. One percent is equal to 10,000 ppm. Another unit commonly used to describe the effective concentration is milliequivalents per liter (meq/L). The concentration in meq/L equals the concentration in mg/L divided by the equivalent weight of the respective salt.

Measuring the concentration of salt in soil water is difficult; therefore, simplified methods have been developed to measure and quantify the salinity level. Solutions that contain salt conduct electricity. The electrical conductivity of the soil water (EC_e) is directly proportional to the ionic concentration. The most common unit for EC_e is millimhos per centimeter (mmho/cm). Electrical conductivity is now more commonly expressed as decisiemens per meter (dS/m), where 1 dS/m = 1 mmho/cm. One mmho/cm normally equals a concentration of 640 ppm or 640 mg/L. The standard temperature for measuring the electrical conductivity is 77 °F (25 °C).

The electrical conductivity of the soil water generally is determined by mixing a soil sample with distilled water to a specified consistency called a “saturated

paste” from which some water is vacuum extracted. The water that is extracted is called the saturated-soil extract and is used for most chemical analyzes. The electrical conductivity of the saturated-soil extract is denoted as EC_e and is expressed in mmho/cm or dS/m.

If the concentration of soluble salts in the root zone becomes excessive, crop yields are reduced because of physical damage to the plant. The objective of irrigation is to maintain the soil-water content and the salinity level within suitable ranges for optimum plant growth.

Crop yield reductions can result from plant stress caused by the salt concentration (osmotic potential), toxicity of certain specific salts, nutrient imbalances created when specific salts become excessive, or from a reduction of soil permeability. The extent to which salts accumulate in the soil depends upon the irrigation water quantity and quality, irrigation management practices, amount and distribution of rainfall, and the adequacy of drainage.

To prevent yield loss, the salt concentration in the crop root zone must be maintained below a level that affects yield. To prevent soil salinity from reaching these harmful levels, a part of the concentrated salt solution must be leached from the crop root zone. Salts leach whenever the total water application by rainfall or irrigation exceeds depletion by crop evapotranspiration, provided that soil infiltration and drainage rates are adequate. Rainfall, which contains little salt, may remove salts from the root zone. However, in many locations rainfall is inadequate and provisions must be made for adequate leaching through application of additional irrigation water.

Other salinity management alternatives should also be considered. They include more frequent irrigations, other crop selection, seed bed preparation and placement, changing irrigation method, changing water supply, subsurface drainage, nutrient and water management, tillage management, and improving water application distribution uniformity. These alternatives are discussed in greater detail in section 623.0205(e).

Plants extract water from the soil by exerting an absorptive force greater than the attraction of the soil matrix for water. As the soil dries, remaining water in the soil profile is held more tightly to soil particles.

Salts also attract water. The combination of drying soils and elevated salt concentrations result in less water being available for plant uptake. The cumulative effect of salts in a drying clay loam is illustrated in figure 2-28. The reduction in water available to the crop as salinity increases is evident in this figure. Under conditions of low salinity ($EC_e = 1$ mmho/cm), the available water is about 2 inches per foot. Where the salinity level increases to an average of 16 mmho/cm, the available water is reduced to about 1.6 inches per foot.

Salt affected soils generally are broken into three categories: saline soil, saline-alkali soil, and nonsaline-alkali soil.

Saline soil—This soil contains salts that provide an electrical conductivity of the soil-water extract, EC_e of more than 4.0 mmho/cm, and an exchangeable sodium percentage (ESP) of less than 15. The principal anions are chloride, sulfate, small amounts of bicarbonate, and occasionally some nitrate.

Saline-sodic soil—This soil contains salts that provide an EC_e of more than 4.0 mmho/cm and an ESP of more than 15. It is difficult to leach because the clay colloids are dispersed.

Nonsaline-sodic soil—This soil contains salts that provide an EC_e of less than 4.0 mmho/cm and an ESP of more than 15. It is commonly called "black alkali" or "slick spots."

(b) Water quality evaluation

The water's suitability for irrigation depends on the total amount and kind of salts in the water, the crops grown, soil properties, irrigation management, cultural practices, and climatic factors. The relative amount of various cations in the saturated-soil extract is used to characterize the soil water. Sodium Absorption Ratio (SAR), the most often used term, is defined as:

$$SAR = \frac{Na}{\sqrt{\frac{(Ca + Mg)}{2}}} \quad [2-69]$$

where:

Na, Ca, and Mg = concentrations of sodium, calcium, and magnesium (meq/L)

The adjusted SAR procedure presented in the first edition of the Food and Agriculture Organization's FAO-29 is no longer recommended (Ayres & Westcot 1985).

The evaluation of water quality is based on the kind of problems most commonly encountered with salt-affected water—salinity, permeability, and toxicity—and other miscellaneous effects. **Salinity** describes the conditions where salts in the root zone reduce soil-water availability (as illustrated in fig. 2-28) to such an extent that yield is affected.

A **permeability** problem occurs when the soil or water is relatively high in sodium, or low in calcium, so that the infiltration rate decreases to the point that sufficient water cannot infiltrate to adequately supply the crop. Where exchangeable sodium is excessive, soil permeability is reduced for a given salinity level of the infiltrating water and soil pH. Low salinity and high pH can also decrease soil permeability as much as sodium.

The exact level of sodium that causes problems is difficult to quantify because it depends on at least the soil texture, mineralogy, organic matter, and soil and water management. Certain ions (sodium, boron, or chloride) from soil or water may accumulate in concentrations high enough to reduce yields in sensitive crops. This reaction is described as specific ion **toxicity**.

Figure 2-28 Example soil-water retention curves for a clay-loam soil at various degrees of soil salinity (EC_e) (Ayres and Westcot 1985)

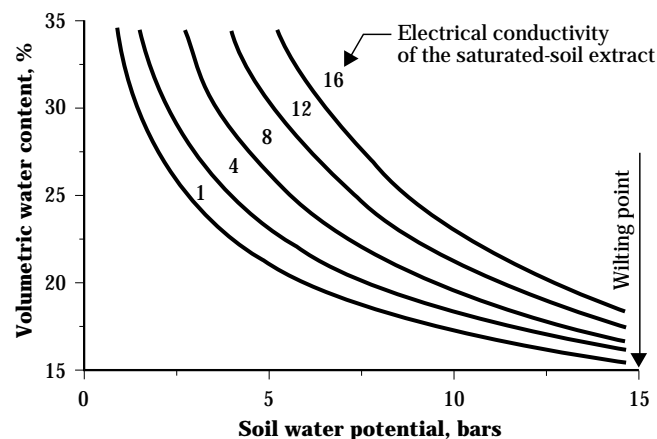

Table 2-32 Irrigation water quality guidelines ^{1/}

Potential irrigation water quality problem	Describing parameter	----- Degree of restriction on use -----		
		None	Slight to moderate	Severe
Salinity (affects crop water availability)				
	EC _i ^{2/} , mmho/cm	< 0.7	0.7 – 3.0	> 3.0
	or TDS ^{3/} , mg/L	< 450	450 – 2,000	> 2,000
Infiltration (affects water infiltration rate— evaluated by using EC _i and SAR together) ^{4/}				
	SAR		EC _i , mmho/cm	
	0 – 3	> 0.7	0.7 – 0.2	< 0.2
	3 – 6	> 1.2	1.2 – 0.3	< 0.3
	6 – 12	> 1.9	1.9 – 0.5	< 0.5
	12 – 20	> 2.9	2.9 – 1.3	< 1.3
	20 – 40	> 5.0	5.0 – 2.9	< 2.9
Specific ion toxicity (affects sensitive crops)				
Sodium (Na) ^{5/}				
surface irrigation	SAR	< 3	3 – 9	> 9
sprinkler irrigation	meq/L	< 3	> 3	
Chloride (Cl) ^{5/}				
surface irrigation	meq/L	< 4	4 – 10	> 10
sprinkler irrigation	meq/L	< 3	> 3	
Boron (B) ^{6/}				
	meq/L	< 0.7	0.7 – 3.0	> 3.0
Miscellaneous effects (affects susceptible crops)				
Bicarbonate (HCO ₃) (overhead sprinkling only)				
	meq/L	< 1.5	1.5 – 8.5	> 8.5

1/ Adapted from Ayers and Westcot (1985), FAO 29, revision 1.

2/ EC_i means electrical conductivity of the irrigation water reported in mmho/cm at 77 °F (25 °C).

3/ TDS means total dissolved solids reported in mg/L.

4/ SAR means sodium adsorption ratio. At a given SAR, infiltration rate increases as water salinity increases.

5/ For surface irrigation—Most tree crops and woody plants are sensitive to sodium and chloride, so the values shown should be used. Because most annual crops are not sensitive, the salinity tolerance values in table 2-34 should be used. For chloride tolerance of selected fruit crops, see table 2-35. With overhead sprinkler irrigation and low humidity (<30%), sodium and chloride may be absorbed through the leaves of sensitive crops. For crop sensitivity to absorption, see table 2-36.

6/ For boron tolerances see tables 2-37 and 2-38.

Guidelines for evaluating water quality for irrigation are given in table 2-32. These guidelines are limited to water quality parameters that are normally encountered and that materially affect crop production. They are meant as an initial management guide and involve several assumptions. Specific discussion regarding the information this table is in Ayers and Westcot (1985). The division of this table into "Restriction on Use" is somewhat arbitrary because changes are gradual. Changes of 10 to 20 percent above or below the guideline values have little significance if considered in perspective with other factors affecting yield.

Distinction must be made between the electrical conductivity of the irrigation water (EC_i) and the applied water (EC_{aw}), including rainfall, and the saturated-soil extract (EC_e). The soil salinity expressed as

EC_e depends upon the electrical conductivity of the irrigation water and the amount of leaching that is taking place. These relationships are discussed in a later section where the leaching requirement is defined. Figures 2-29 and 2-30 may also be used to assess the salinity hazard as a function of irrigation water quality (Rhoades and Loveday 1990). Likewise, figure 2-31 can be used to determine the likelihood of a permeability hazard.

Laboratory determinations and calculations needed to use the guidelines of table 2-32 are in table 2-33. Analytical procedures for the laboratory determinations are given in several publications including USDA Agricultural Handbook 60 (USDA 1954) and others.

Table 2-33 Determinations normally required to evaluate irrigation water quality problems ^{1/}

Determination	Symbol	Valence	Unit of measure ^{2/}	Atomic weight	Usual range in irrigation water
Total salt content					
Electrical conductivity	EC	—	mmho/cm	—	0-3
Concentration or total dissolved solids	TDS	—	mg/L	—	0-2000
Sodium hazard					
Sodium adsorption ratio ^{3/}	SAR	—	—	—	0-15
Constituents					
Cations: Calcium	Ca	+2	meq/L	40.1	0-20
Magnesium	Mg	+2	meq/L	24.3	0-5
Sodium	Na	+1	meq/L	23.0	0-40
Anions: Bicarbonate	HCO ₃	-1	meq/L	61.0	0-10
Sulfate	SO ₄	-2	meq/L	96.1	0-20
Chloride	Cl	-1	meq/L	35.3	0-30
Trace elements					
Boron	B	—	mg/L	10.8	0-2
Acid/basic	pH	—	1-14	—	6.0-8.5

1/ Adapted from Ayers and Westcot (1985).

2/ Millimhos/cm (1 mmho/cm) referenced to 77 °F (25 °C).
mg/L = milligram per liter ≈ parts per million (ppm).
meq/L = milliequivalent per liter (mg/L ÷ equivalent weight = meq/L).

3/ SAR is calculated by the following equation, with each concentration reported in meq/L.

$$SAR = \frac{Na}{\sqrt{\frac{(Ca+Mg)}{2}}}$$

Figure 2-29 Relationship among average root zone salinity (saturation extract basis), electrical conductivity of irrigation water, and leaching fraction to use for conditions of **conventional irrigation** management (adapted from Rhoades 1982)

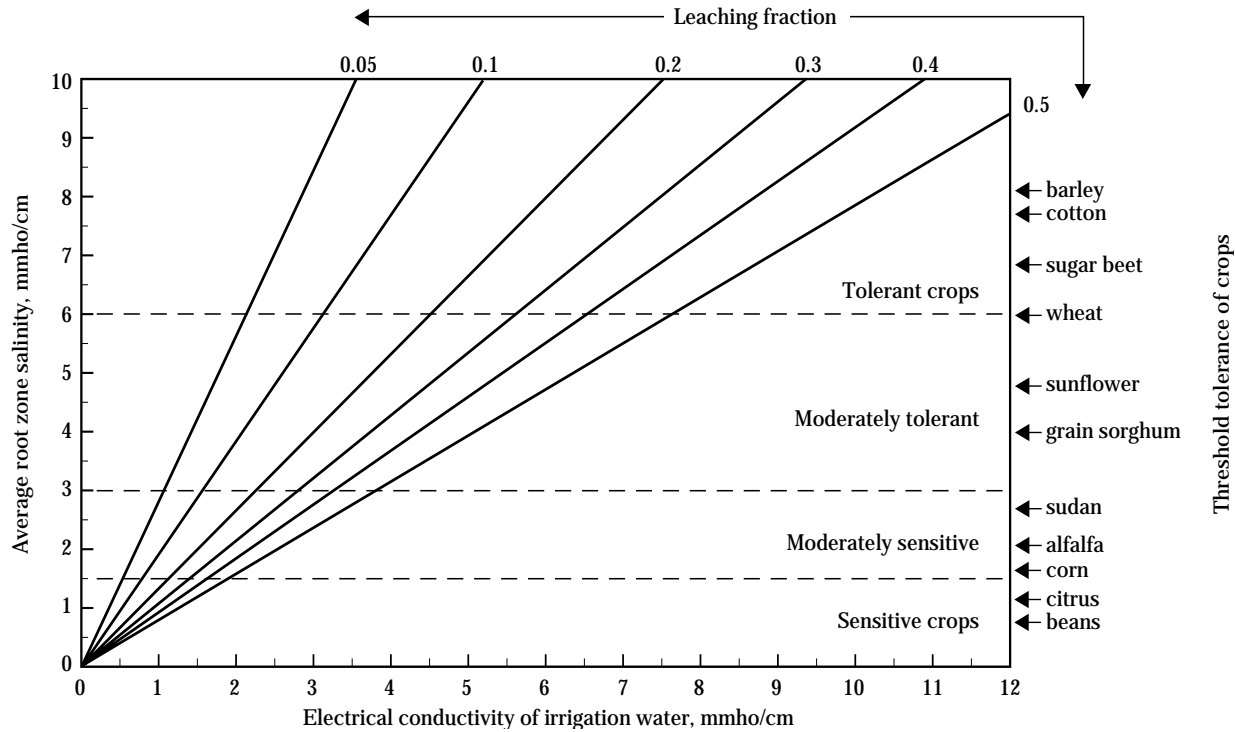

Figure 2-30 Relationship among water uptake-weighted salinity (saturation extract basis), electrical conductivity of irrigation water, and leaching fraction to use for conditions of **high-frequency irrigation** (adapted from Rhoades 1982)

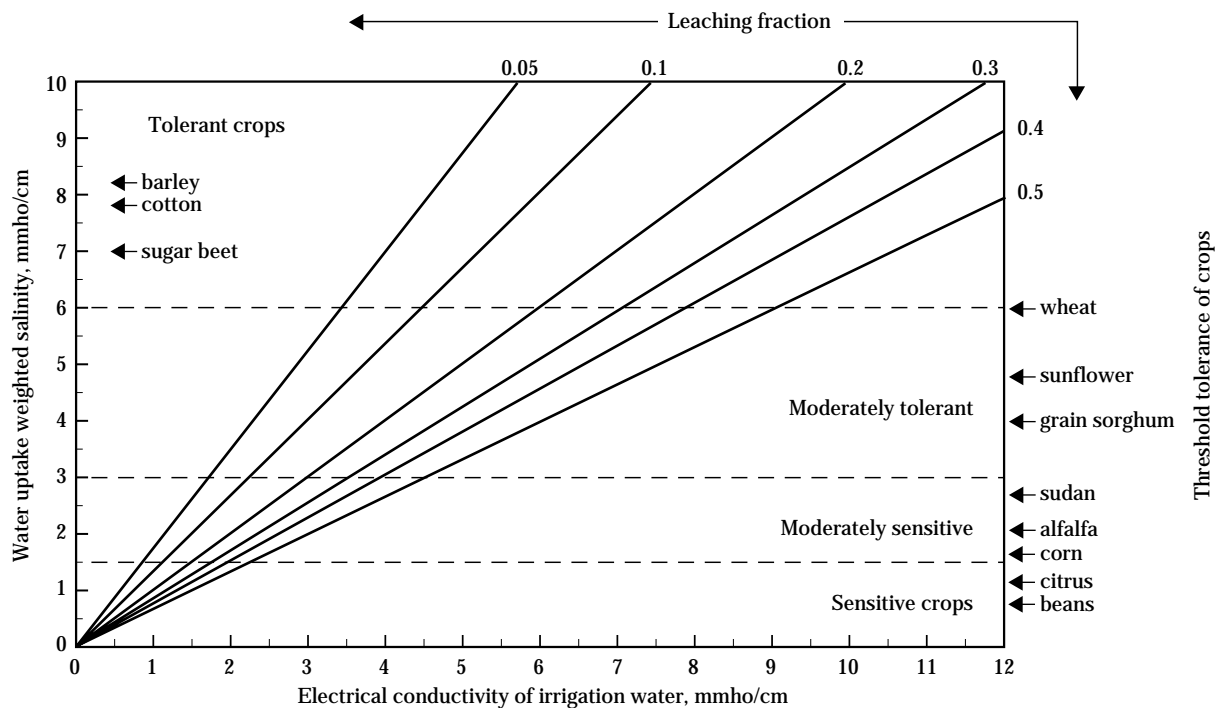
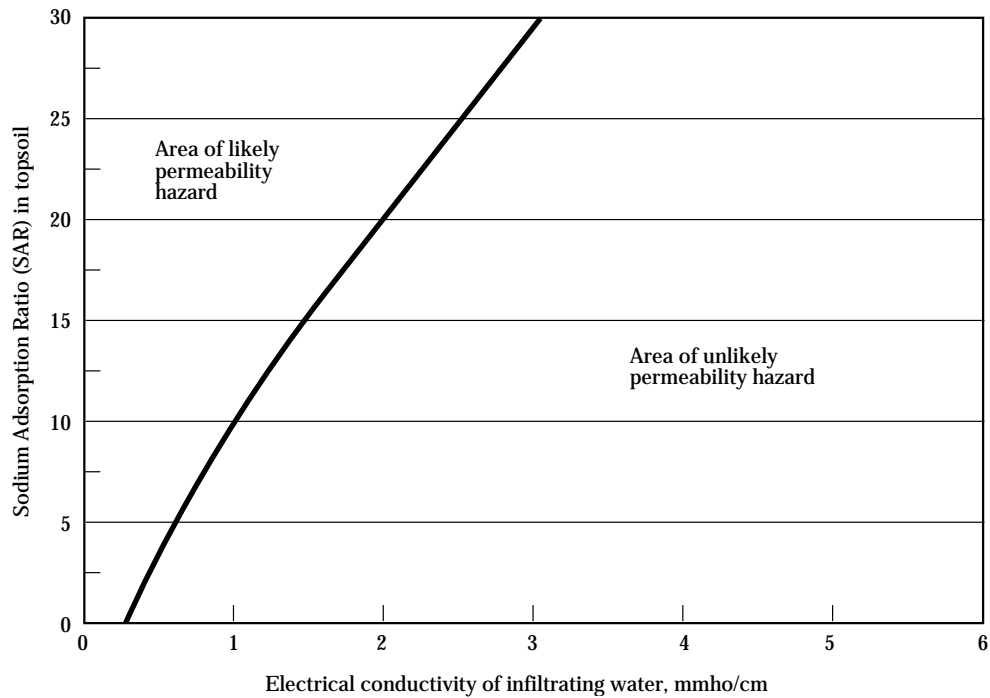

Figure 2-31 Threshold values of Sodium Adsorption Ratio of topsoil and electrical conductivity of infiltrating water associated with the likelihood of substantial losses in permeability (adapted from Rhoades 1982)



(c) Crop salt tolerance

(1) Plant response to salts

Increasing salinity levels in the crop root zone incrementally suppresses growth and crop yield until the plant dies. Suppression typically depends more on osmotic stress created by the total concentration of soluble salts than on specific ion effects.

Although salinity affects plants in many ways, visible symptoms, such as leaf burn or necrosis, seldom occur. Crop yields will have been reduced drastically when symptoms do become visible. Salinity can cause morphological and anatomical changes, which in some cases may improve plant survival, but with reduced yields. Adaptations, which vary with plant species and the type of salinity, include fewer and smaller leaves and thickening of leaf cuticles.

The sensitivity of plants to salt varies with growth stage. Salt tolerance at emergence is normally based on survival rates, whereas tolerance after emergence is based on decreases in plant growth or yield. Crops generally are as salt tolerant at germination as at later stages of development. During germination the salt concentrations are usually higher in the limited root zone because of soil evaporation and plant transpiration from the soil surface layer. Such crops as barley, corn, rice, sorghum and wheat are most sensitive during seedling and early reproductive growth and are more tolerant during later growth stages (Maas 1990).

Many environmental factors interact with salinity to influence crop salt tolerance. Most crops are more sensitive to salinity under hot, dry conditions than cool, humid ones. High atmospheric humidity with no wind alone tends to increase the salt tolerance of some crops, generally benefitting salt-sensitive crops more than salt-tolerant ones.

Soil fertility may also alter plant response under saline conditions. Crops grown on infertile soils may seem more salt tolerant than those grown with adequate fertility because fertility, not salinity, is the growth-limiting factor. Proper fertilization would increase yields whether or not the soil was saline, but proportionately more if it was not saline. Application of fertilizers, including nitrogen, phosphorus, and potassium, above normally adequate levels under saline conditions is a questionable practice. Excess applications of nitrogen have been reported to increase salt

tolerance in some crops; others have reported decreases. Phosphorous levels in soil, even with heavy applications, are rarely excessive because phosphorous is adsorbed or precipitated in the soil. Excessive potassium rates do not appear to influence salt tolerance.

(2) Salt tolerance evaluation

The ability of plants to produce economic yields in a saline environment is termed salt tolerance. Agricultural crops differ significantly in their response to excessive concentrations of soluble salts in the root zone. Thus, crop selection is one of the primary options available to growers to maximize productivity under saline conditions. The effects of salinity on crop production are typically divided into two categories:

- **Salt tolerance**—the adverse effect on crop yields of dissolved salts in the soil solution that increases osmotic stress.
- **Toxicity**—caused by specific solutes that reduce growth and yield beyond that attributable to osmotic effects.

The relative salt tolerances of selected agricultural crops are summarized in table 2-34. The table lists two essential parameters sufficient to evaluate salt tolerance: (1) the threshold salinity level, which is the maximum allowable salinity that does not reduce yield measurably below that of a nonsaline condition, and (2) the yield decrease per unit of salinity increase beyond the threshold. All salinity levels are reported as EC_e (the electrical conductivity of the saturated-soil extract reported in mmho/cm and corrected for temperature to 77 °F). A qualitative salt-tolerance rating is also given for relative comparisons among crops. These ratings are defined by the boundaries shown in figure 2-32.

In equation form, the salt tolerance is represented by: [2-70]

$$\begin{aligned}
 Y_r &= 100 & 0 \leq EC_e \leq EC_t \\
 &= 100 - Y_d(EC_e - EC_t) & EC_t \leq EC_e \leq EC_y \\
 &= 0 & EC_e > EC_y
 \end{aligned}$$

where:

- Y_r = the relative crop yield (actual yield at the given salinity level divided by yield with no salinity effect)
- EC_e = the average root zone salinity (mmho/cm)
- EC_t = the threshold salinity level (mmho/cm)
- Y_d = the yield decrease per unit of salinity increase (% per mmho/cm)
- EC_y = the level of soil salinity above which the yield is zero

For example, alfalfa (table 2-34) yields decrease about 7.3 percent per unit of salinity increase when the soil salinity exceeds 2.0 mmho/cm ($EC_t = 2$ mmho/cm, $Y_d = 7.3\%$). Therefore, at a soil salinity of 5.4 mmho/cm ($EC_e = 5.4$ mmho/cm), the relative yield for alfalfa is:

$$Y_r = 100 - 7.3 (5.4 - 2.0) = 75\%$$

The data presented in table 2-34 were developed from experiments where the salinity treatments were imposed after the seedling stage. Therefore, they do not necessarily represent salt tolerance for the germination and early seedling growth stages.

The threshold and slope coefficients given in this table were typically established from small field plot experiments where large quantities of water were applied to minimize differences in soil salinity through the crop root zone. The question frequently arises as to the applicability of the coefficients to field conditions. Hoffman (1986) reported that several unrelated tests have provided evidence that the coefficients are valid over a range of leaching fractions, irrigation intervals, and soil salinity profiles.

Figure 2-32 Divisions for classifying crop tolerance to salinity (adapted from Maas 1986)

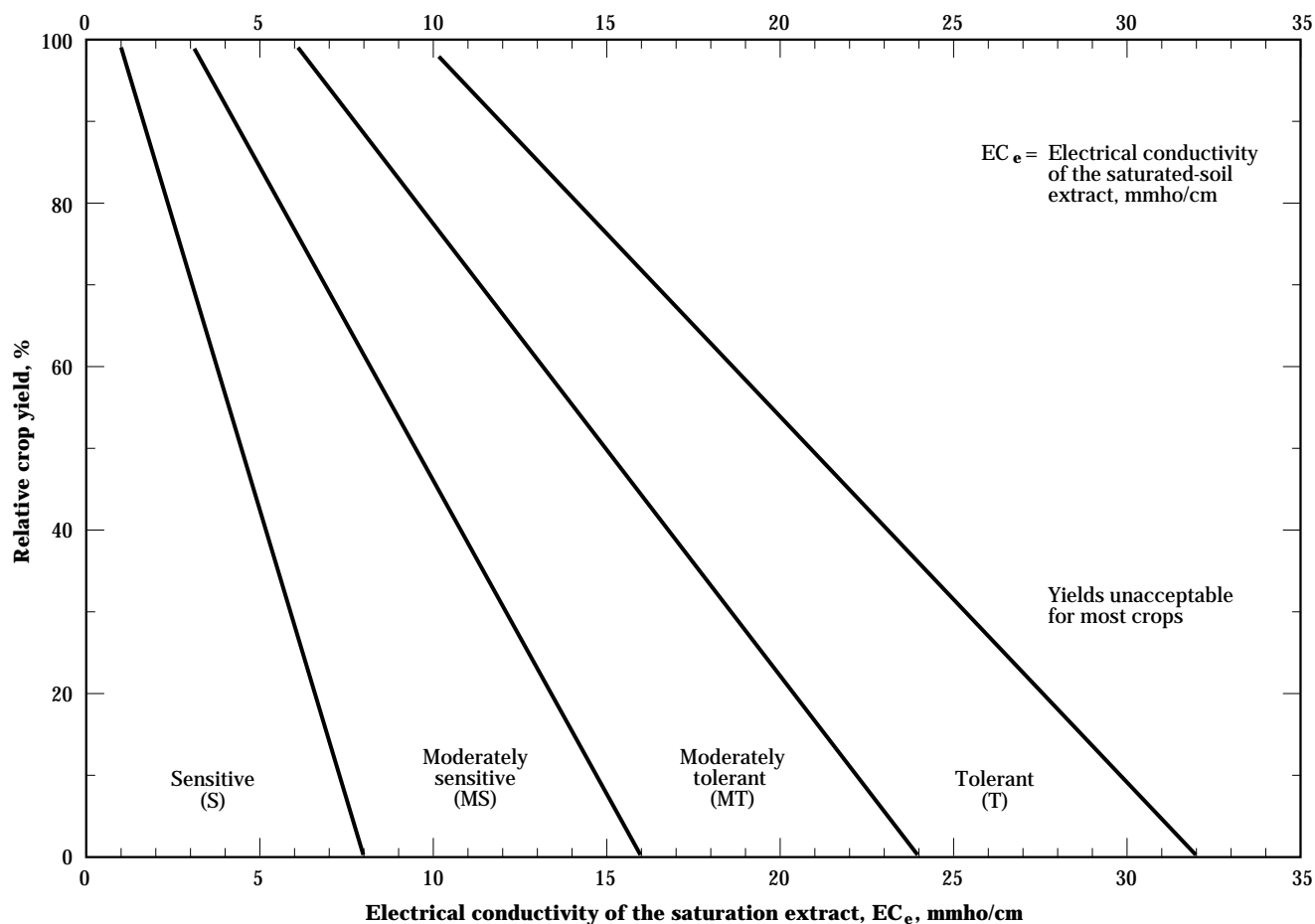

Table 2-34 Salt tolerance of selected crops ^{1/}

Common name	Botanical name	Salt tolerance threshold ^{2/}	Yield decline ^{3/}	Qualitative salt tolerance rating ^{4/}
		(EC _t)	(Y _d)	
		mmho/cm	% per mmho/cm	
Field crops				
Barley	<i>Hordeum vulgare</i>	8.0	5.0	T
Bean	<i>Phaseolus vulgaris</i>	1.0	19	S
Broad bean	<i>Vicia faba</i>	1.6	9.6	MS
Corn	<i>Zea Mays</i>	1.7	12	MS
Cotton	<i>Gossypium hirsutum</i>	7.7	5.2	T
Cowpea	<i>Vigna unguiculata</i>	4.9	12	MT
Flax	<i>Linum usitatissimum</i>	1.7	12	MS
Guar	<i>Cyamopsis tetragonoloba</i>	8.8	17.0	T
Millet, foxtail	<i>Setaria italica</i>	—	—	MS
Oats	<i>Avena sativa</i>	—	—	MT
Peanut	<i>Arachis hypogaea</i>	3.2	29	MS
Rice, paddy ^{5/}	<i>Oryza sativa</i>	3.0	12	S
Rye	<i>Secale cereale</i>	11.4	10.8	T
Safflower	<i>Carthamus tinctorius</i>	—	—	MT
Sesame	<i>Sesamum indicum</i>	—	—	S
Sorghum	<i>Sorghum bicolor</i>	6.8	16	MT
Soybean	<i>Glycine max</i>	5.0	20	MT
Sugar beet	<i>Beta vulgaris</i>	7.0	5.9	T
Sugarcane	<i>Saccharum officinarum</i>	1.7	5.9	MS
Sunflower	<i>Helianthus annuus</i>	—	—	MS
Triticale	<i>x Triticosecale</i>	6.1	2.5	T
Wheat	<i>Triticum aestivum</i>	6.0	7.1	MT
Wheat (semidwarf)	<i>T. aestivum</i>	8.6	3.0	T
Wheat, durum	<i>T. turgidum</i>	5.9	3.8	T
Grasses and forage crops				
Alfalfa	<i>Medicago sativa</i>	2.0	7.3	MS
Alkaligrass, nuttall	<i>Puccinellia airoides</i>	—	—	T
Alkali sacaton	<i>Sporobolus airoides</i>	—	—	T
Barley (forage)	<i>Hordeum vulgare</i>	6.0	7.1	MT
Bentgrass	<i>Agrostis stolonifera palustris</i>	—	—	MS
Bermudagrass	<i>Cynodon dactylon</i>	6.9	6.4	T
Bluestem, angleton	<i>Dichanthium aristatum</i>	—	—	MS
Brome, mountain	<i>Bromus marginatus</i>	—	—	MT
Brome, smooth	<i>B. inermis</i>	—	—	MS
Buffelgrass	<i>Cenchrus ciliaris</i>	—	—	MS
Burnet	<i>Poterium sanguisorba</i>	—	—	MS
Canarygrass, reed	<i>Phalaris arundinacea</i>	—	—	MT

See footnotes at end of table.

Table 2-34 Salt tolerance of selected crops^{1/}—Continued

Common name	Botanical name	Salt tolerance threshold ^{2/}	Yield decline ^{3/}	Qualitative salt tolerance rating ^{4/}
		(EC _d)	(Y _d)	
		mmho/cm	% per mmho/cm	
Grasses and forage crops (continued)				
Clover, alsike	<i>Trifolium hybridum</i>	1.5	12	MS
Clover, berseem	<i>T. alexandrinum</i>	1.5	5.7	MS
Clover, hubam	<i>Melilotus alba</i>	—	—	MT
Clover, ladino	<i>Trifolium repens</i>	1.5	12	MS
Clover, red	<i>T. pratense</i>	1.5	12	MS
Clover, strawberry	<i>T. fragiferum</i>	1.5	12	MS
Clover, sweet	<i>Melilotus</i>	—	—	MT
Clover, white Dutch	<i>Trifolium repens</i>	—	—	MS
Corn (forage)	<i>Zea mays</i>	1.8	7.4	MS
Cowpea (forage)	<i>Vigna unguiculata</i>	2.5	11	MS
Dallisgrass	<i>Paspalum dilatatum</i>	—	—	MS
Fescue, tall	<i>Festuca elatior</i>	3.9	5.3	MT
Fescue, meadow	<i>F. pratensis</i>	—	—	MT
Foxtail, meadow	<i>Alopecurus pratensis</i>	1.5	9.6	MS
Gramma, blue	<i>Bouteloua gracilis</i>	—	—	MS
Hardinggrass	<i>Phalaris tuberosa</i>	4.6	7.6	MT
Kallar grass	<i>Diplachne fusca</i>	—	—	T
Lovegrass	<i>Eragrostis sp.</i>	2.0	8.4	MS
Milkvetch, cicer	<i>Astragalus cicer</i>	—	—	MS
Oatgrass, tall	<i>Arrhenatherum, Danthonia</i>	—	—	MS
Oats (forage)	<i>Avena sativa</i>	—	—	MS
Orchardgrass	<i>Dactylis glomerata</i>	1.5	6.2	MS
Panicgrass, blue	<i>Panicum antidotale</i>	—	—	MT
Rape	<i>Brassica napus</i>	—	—	MT
Rescuegrass	<i>Bromus unioloides</i>	—	—	MT
Rhodesgrass	<i>Chloris gayana</i>	—	—	MT
Rye (forage)	<i>Secale cereale</i>	—	—	MS
Ryegrass, Italian	<i>Lolium italicum multiflorum</i>	—	—	MT
Ryegrass, perennial	<i>L. perenne</i>	5.6	7.6	MT
Saltgrass, desert	<i>Distichlis stricta</i>	—	—	T
Sesbania	<i>Sesbania exaltata</i>	2.3	7.0	MS
Siratro	<i>Macroptilium atropurpureum</i>	—	—	MS
Sphaerophysa	<i>Sphaerophysa salsula</i>	2.2	7.0	MS
Sudangrass	<i>Sorghum sudanense</i>	2.8	4.3	MT
Timothy	<i>Phleum pratense</i>	—	—	MS
Trefoil, big	<i>Lotus uliginosus</i>	2.3	19	MS
Trefoil, narrowleaf birdsfoot	<i>L. corniculatus tenuifolium</i>	5.0	10	MT
Trefoil, broadleaf birdsfoot	<i>L. corniculatus arvensis</i>	—	—	MT

See footnotes at end of table.

Table 2-34 Salt tolerance of selected crops^{1/}—Continued

Common name	Botanical name	Salt tolerance threshold ^{2/}	Yield decline ^{3/}	Qualitative salt tolerance rating ^{4/}
		(EC _t)	(Y _d)	
		mmho/cm	% per mmho/cm	
Grasses and forage crops (continued)				
Vetch, common	<i>Vicia angustifolia</i>	3.0	11	MS
Wheat (forage)	<i>Triticum aestivum</i>	4.5	2.6	MT
Wheat, durum (forage)	<i>T. turgidum</i>	2.1	2.5	MT
Wheatgrass, standard crested	<i>Agropyron sibiricum</i>	3.5	4.0	MT
Wheatgrass, fairway crested	<i>A. cristatum</i>	7.5	6.9	T
Wheatgrass, intermediate	<i>A. intermedium</i>	—	—	MT
Wheatgrass, slender	<i>A. trachycaulum</i>	—	—	MT
Wheatgrass, tall	<i>A. elongatum</i>	7.5	4.2	T
Wheatgrass, western	<i>A. smithii</i>	—	—	MT
Wildrye, Altai	<i>Elymus angustus</i>	—	—	T
Wildrye, beardless	<i>E. triticooides</i>	2.7	6.0	MT
Wildrye, Canadian	<i>E. canadensis</i>	—	—	MT
Wildrye, Russian	<i>E. junceus</i>	—	—	T
Vegetable and fruit crops				
Artichoke	<i>Helianthus tuberosus</i>	—	—	MT
Asparagus	<i>Asparagus officinalis</i>	4.1	2.0	T
Bean	<i>Phaseolus vulgaris</i>	1.0	19	S
Beet, red	<i>Beta vulgaris</i>	4.0	9.0	MT
Broccoli	<i>Brassica oleracea botrytis</i>	2.8	9.2	MS
Brussels sprouts	<i>B. oleracea gemmifera</i>	—	—	MS
Cabbage	<i>B. oleracea capitata</i>	1.8	9.7	MS
Carrot	<i>Daucus carota</i>	1.0	14	S
Cauliflower	<i>B. oleracea botrytis</i>	—	—	MS
Celery	<i>Apium graveolens</i>	1.8	6.2	MS
Corn, sweet	<i>Zea mays</i>	1.7	12	MS
Cucumber	<i>Cucumis sativus</i>	2.5	13	MS
Eggplant	<i>Solanum melongena esculentum</i>	1.16.9	MS	
Kale	<i>B. oleracea acephala</i>	—	—	MS
Kohlrabi	<i>B. oleracea gongylodes</i>	—	—	MS
Lettuce	<i>Lactuca sativa</i>	1.3	13	MS
Muskmelon	<i>Cucumis melo</i>	—	—	MS
Okra	<i>Abelmoschus esculentus</i>	—	—	S
Onion	<i>Allium cepa</i>	1.2	16	S
Parsnip	<i>Pastinaca sativa</i>	—	—	S
Pea	<i>Pisum sativum</i>	—	—	S
Pepper	<i>Capsicum annuum</i>	1.5	14	MS
Potato	<i>Solanum tuberosum</i>	1.7	12	MS

See footnotes at end of table.

Table 2-34 Salt tolerance of selected crops^{1/}—Continued

Common name	Botanical name	Salt tolerance threshold ^{2/}	Yield decline ^{3/}	Qualitative salt tolerance rating ^{4/}
		(EC _d)	(Y _d)	
		mmho/cm	% per mmho/cm	
Vegetable and fruit crops (continued)				
Pumpkin	<i>Cucurbita pepo pepo</i>	—	—	MS
Radish	<i>Raphanus sativus</i>	1.2	13	MS
Spinach	<i>Spinacia oleracea</i>	2.0	7.6	MS
Squash, scallop	<i>Cucurbita pepo melopepo</i>	3.2	16	MS
Squash, zucchini	<i>C. pepo melopepo</i>	4.7	9.4	MT
Strawberry	<i>Fragaria sp.</i>	1.0	33	S
Sweet potato	<i>Ipomoea batatas</i>	1.5	11	MS
Tomato	<i>Lycopersicon lycopersicum</i>	2.5	9.9	MS
Turnip	<i>Brassica rapa</i>	0.9	9.0	MS
Watermelon	<i>Citrullus lanatus</i>	—	—	MS
Woody crops				
Almond	<i>Prunus dulcis</i>	1.5	19	S
Apple	<i>Malus sylvestris</i>	—	—	S
Apricot	<i>P. armeniaca</i>	1.6	24	S
Avocado	<i>Persea americana</i>	—	—	S
Blackberry	<i>Rubus sp.</i>	1.5	22	S
Boysenberry	<i>Rubus ursinus</i>	1.5	22	S
Castor bean	<i>Ricinus communis</i>	—	—	MS
Cherimoya	<i>Annona cherimola</i>	—	—	S
Cherry, sweet	<i>Prunus avium</i>	—	—	S
Cherry, sand	<i>P. besseyi</i>	—	—	S
Currant	<i>Ribes sp.</i>	—	—	S
Date palm	<i>Phoenix dactylifera</i>	4.0	3.6	T
Fig	<i>Ficus carica</i>	—	—	MT
Gooseberry	<i>Ribes sp.</i>	—	—	S
Grape	<i>Vitis sp.</i>	1.5	9.6	MS
Grapefruit	<i>Citrus paradisi</i>	1.8	16	S
Guayule	<i>Parthenium argentatum</i>	8.7	11.6	T
Jojoba	<i>Simmondsia chinensis</i>	—	—	T
Jujube	<i>Ziziphus jujuba</i>	—	—	MT
Lemon	<i>C. limon</i>	—	—	S
Lime	<i>C aurantiifolia</i>	—	—	S
Loquat	<i>Eriobotrya japonica</i>	—	—	S
Mango	<i>Mangifera indica</i>	—	—	S
Olive	<i>Olea europaea</i>	—	—	MT
Orange	<i>C. sinensis</i>	1.7	16	S
Papaya	<i>Carica papaya</i>	—	—	MT

See footnotes at end of table.

Table 2-34 Salt tolerance of selected crops^{1/}—Continued

Common name	Botanical name	Salt tolerance threshold ^{2/}	Yield decline ^{3/}	Qualitative salt tolerance rating ^{4/}
		(EC _t)	(Y _d)	
		mmho/cm	% per mmho/cm	
Woody crops (continued)				
Passion fruit	<i>Passiflora edulis</i>	—	—	S
Peach	<i>Prunus persica</i>	1.7	21	S
Pear	<i>Pyrus communis</i>	—	—	S
Persimmon	<i>Diospyros virginiana</i>	—	—	S
Pineapple	<i>Ananas comosus</i>	—	—	MT
Plum; prune	<i>Prunus domestica</i>	1.5	18	S
Pomegranate	<i>Punica granatum</i>	—	—	MT
Pummelo	<i>Citrus maxima</i>	—	—	S
Raspberry	<i>Rubus idaeus</i>	—	—	S
Rose apple	<i>Syzygium jambos</i>	—	—	S
Sapote, white	<i>Casimiroa edulis</i>	—	—	S
Tangerine	<i>Citrus reticulata</i>	—	—	S

1/ Adapted from Maas and Hoffman (1977) and Maas (1990). Data serve as a guide to relative tolerances. Absolute tolerances depend upon climate, soil conditions, and cultural practices. Note: 1 mmho/cm = 1 dS/m.

2/ Salt tolerance threshold (EC_t) is the mean soil salinity at initial yield decline. Salinity expressed as EC_e in mmho/cm referenced to 77 °F (25 °C).

3/ Percent yield decline (Y_d) is the rate of yield reduction per unit increase in salinity beyond the threshold.

4/ Qualitative salt tolerance ratings are sensitive (S), moderately sensitive (MS), moderately tolerant (MT), and tolerant (T) as shown in figure 2-32.

5/ Values are for soil water while plants are submerged. Less tolerant during seedling stage.

(3) Specific ion effects

Toxicity problems are different from those of salinity because they occur within the plant and are not caused by osmotic potential or water stress. Toxicity normally results when certain ions are absorbed with soil-water, move with the plant transpiration stream, and accumulate in the leaves at concentrations that cause plant damage. The extent of damage depends upon the specific ion concentration, crop sensitivity, crop growth stage, and crop water use rate and time. The usual toxic ions present in irrigation water include chloride, sodium, and boron. Not all crops are sensitive to these ions. Most annual crops are not sensitive at the concentrations given in table 2-32. However, many tree crops and other woody perennials are susceptible. Toxicity often accompanies or complicates a salinity or infiltration problem although it may appear even when salinity is low.

Chemical analysis of plant tissue, soil-water extract, or irrigation water is most commonly used to identify toxicity problems. Leaf injury symptoms appear in chloride-sensitive crops when leaves accumulate about 0.3 to 0.5 percent chloride on a dry weight basis. Maximum permissible concentrations of chloride in the saturated-soil extract for several crops are given in table 2-35.

Symptoms of sodium toxicity occur first on older leaves as a burning or drying of tissue at the outer edges of the leaf. As severity increases, the affected zone progresses toward the center of the leaf between the veins. Sodium toxicity is often modified and reduced if calcium is present. Because of this interaction, a reasonable evaluation of the potential toxicity is given by the exchangeable-sodium-percentage (ESP) of the soil or the SAR of saturated-soil extracts or irrigation water (USDA 1954). Tolerances of representative crops to sodium are given in table 2-36.

Boron is an essential minor element, but if concentrations exceed only slightly that required for optimum plant growth, it becomes toxic. Boron toxicity symptoms typically appear at the tip and along the edges of older leaves as yellowing, spotting, drying of leaf tissue, or a combination of these. The damage gradually progresses toward midleaf. A wide range of crops has been tested for boron tolerance in sand cultures. The results of these tests are summarized in tables 2-37 and 2-38. These data were based on the boron level at which toxicity symptoms were observed, and do not necessarily indicate corresponding yield reductions.

Table 2-35 Chloride tolerance limits of some fruit crop cultivars and rootstocks^{1/}

Crop	Rootstock or cultivar	Maximum permissible chloride concentration of saturated-soil extract without leaf injury ^{2/} (meq/L)
Rootstocks		
Avocado (<i>Persea americana</i>)	West Indian	7.5
	Guatemalan	6.0
Citrus (<i>Citrus spp.</i>)	Mexican	5.0
	Sunki Mandarin	25.0
	grapefruit	25.0
	Cleopatra mandarin	25.0
	Rangpur lime	25.0
	Sampson tangelo	15.0
	rough lemon	15.0
	sour orange	15.0
	Ponkan mandarin	15.0
	Citrumelo 4475	10.0
	trifoliolate orange	10.0
	Cuban shaddock	10.0
Calamondin	10.0	
sweet orange	10.0	
Savage citrange	10.0	
Rusk citrange	10.0	
Troyer citrange	10.0	
Grape (<i>Vitis spp.</i>)	Salt Creek, 1613-3	40.0
	Dog Ridge	30.0
Stone Fruits (<i>Prunus spp.</i>)	Marianna	25.0
	Lovell, Shalil	10.0
	Yunnan	7.5
Cultivars		
Berries (<i>Rubus spp.</i>)	Boysenberry	10.0
	Olallie blackberry	10.0
	Indian summer raspberry	5.0
Grape (<i>Vitis spp.</i>)	Thompson seedless	20.0
	Perlette	20.0
	Cardinal	10.0
	Black Rose	10.0
Strawberry (<i>Fragaria spp.</i>)	Lassen	7.5
	Shasta	5.0

^{1/} Adapted from Maas (1990).

^{2/} For some crops, the concentration given may exceed the overall salinity tolerance of that crop and cause some yield reduction.

Table 2-36 Relative tolerance of selected crops to foliar injury from saline water applied by sprinklers ^{1/2/}----- Na⁺ or Cl⁻ concentrations causing foliar injury ^{3/} -----

< 5 meq/L	5 - 10 meq/L	10 - 20 meq/L	> 20 meq/L
Almond (<i>Prunus dulcis</i>)	Grape (<i>Vitis spp.</i>)	Alfalfa (<i>Medicago sativa</i>)	Cauliflower (<i>Brassica oleracea botrytis</i>)
Apricot (<i>Prunus armeniaca</i>)	Pepper (<i>Capsicum annuum</i>)	Barley (<i>Hordeum vulgare</i>)	Cotton (<i>Gossypium</i>)
Citrus (<i>Citrus spp.</i>) <i>tuberosum</i>)	Potato (<i>Solanum</i>)	<i>hirsutum</i>) Maize (corn) (<i>Zea mays</i>)	Sugar beet (<i>Beta vulgaris</i>)
Plum (<i>Prunus domestica</i>)	Tomato (<i>Lycopersicon lycopersicum</i>)	Cucumber (<i>Cucumis sativus</i>)	Sunflower (<i>Helianthus annuus</i>)
		Safflower (<i>Carthamus tinctorius</i>)	
		Sesame (<i>Sesamum indicum</i>)	
		Sorghum (<i>Sorghum bicolor</i>)	

1/ Data taken from Maas (1990).

2/ Susceptibility based on direct accumulation of salts through the leaves.

3/ Leaf absorption and foliar injury are influenced by cultural and environmental conditions, such as drying winds, low humidity, speed of rotation of sprinklers, and the timing and frequency of irrigations. Data presented are only general guidelines for late spring and summer daytime sprinkling.

Table 2-37 Boron tolerance limits for agricultural crops ^{1/2/}

Common plant name	Scientific plant name	Common plant name	Scientific plant name
Very sensitive (<0.5 mg/L)		Moderately sensitive (1 – 2 mg/L)	
Blackberry ^{3/}	<i>Rubus spp.</i>	Broccoli	<i>Brassica oleracea botrytis</i>
Lemon ^{3/}	<i>Citrus limon</i>	Carrot	<i>Daucus carota</i>
Sensitive (0.5 – 0.75 mg/L)		Cucumber	<i>Cucumis sativus</i>
Apricot ^{3/}	<i>Prunus armeniaca</i>	Lettuce ^{3/}	<i>Lactuca sativa</i>
Avocado ^{3/}	<i>Persea americana</i>	Pea ^{3/}	<i>Pisum sativa</i>
Cherry ^{3/}	<i>Prunus avium</i>	Pepper, red	<i>Capsicum annuum</i>
Fig, kadota ^{3/}	<i>Ficus carica</i>	Potato	<i>Solanum tuberosum</i>
Grape ^{3/}	<i>Vitis vinifera</i>	Radish	<i>Raphanus sativus</i>
Grapefruit ^{3/}	<i>Citrus X paradisi</i>	Moderately tolerant (2.0 – 4.0 mg/L)	
Onion	<i>Allium cepa</i>	Artichoke ^{3/}	<i>Cynara scolymus</i>
Orange ^{3/}	<i>Citrus sinensis</i>	Barley	<i>Hordeum vulgare</i>
Peach ^{3/}	<i>Prunus persica</i>	Bluegrass, Kentucky ^{3/}	<i>Poa pratensis</i>
Pecan ^{3/}	<i>Carya illinoensis</i>	Cabbage ^{3/}	<i>Brassica oleracea capitata</i>
Persimmon ^{3/}	<i>Diospyros kaki</i>	Cauliflower	<i>Brassica oleracea botrytis</i>
Plum ^{3/}	<i>Prunus domestica</i>	Clover, sweet ^{3/}	<i>Melilotus indica</i>
Walnut ^{3/}	<i>Juglans regia</i>	Cowpea ^{3/}	<i>Vigna unguiculata</i>
Sensitive (0.75 – 1.0 mg/L)		Maize (corn)	<i>Zea mays</i>
Artichoke, Jerusalem ^{3/}	<i>Helianthus tuberosus</i>	Muskmelon ^{3/}	<i>Cucumis melo</i>
Bean, kidney ^{3/}	<i>Phaseolus vulgaris</i>	Mustard ^{3/}	<i>Brassica juncea</i>
Bean, lima ^{3/}	<i>Phaseolus lunatus</i>	Squash	<i>Cucurbita pepo</i>
Bean, mung ^{3/}	<i>Vigna radiata</i>	Tobacco ^{3/}	<i>Nicotiana tabacum</i>
Garlic	<i>Allium sativum</i>	Turnip	<i>Brassica rapa</i>
Groundnut/Peanut	<i>Arachis hypogaea</i>	Tolerant (4.0-6.0 mg/L)	
Lupine ^{3/}	<i>Lupinus hartwegii</i>	Alfalfa ^{3/}	<i>Medicago sativa</i>
Sesame ^{3/}	<i>Sesamum indicum</i>	Beet, red	<i>Beta vulgaris</i>
Strawberry ^{3/}	<i>Fragaria spp.</i>	Parsley ^{3/}	<i>Petroselinum crispum</i>
Sunflower	<i>Helianthus annuus</i>	Sugarbeet	<i>Beta vulgaris</i>
Sweet potato	<i>Ipomoea batatas</i>	Tomato	<i>Lycopersicon lycopersicum</i>
Wheat	<i>Triticum eastivum</i>	Vetch, purple ^{3/}	<i>Vicia benghalensis</i>
		Very Tolerant (6.0-15.0 mg/L)	
		Asparagus	<i>Asparagus officinalis</i>
		Celery ^{3/}	<i>Apium graveolens</i>
		Cotton	<i>Gossypium hirsutum</i>
		Sorghum	<i>Sorghum bicolor</i>

1/ Data taken from Maas (1990).

2/ Maximum concentrations tolerated in soil-water without yield or vegetative growth reductions. Boron tolerances vary depending upon climate, soil conditions, and crop varieties.

3/ Tolerance based on reductions in vegetative growth.

Table 2-38 Citrus and stone fruit rootstocks ranked in order of increasing boron accumulation and transport to leaves^{1/}

Common name	Botanical name	Level of boron accumulation
Citrus		
		Low
Alemow	<i>Citrus macrophylla</i>	
Gajanimma	<i>Citrus pennivesiculata</i> or <i>Citrus moi</i>	
Chinese box orange	<i>Severinia buxifolia</i>	
Sour orange	<i>Citrus aurantium</i>	
Calamondin	<i>X Citrofortunella mitis</i>	
Sweet orange	<i>Citrus sinensis</i>	
Yuzu	<i>Citrus junos</i>	
Rough lemon	<i>Citrus limon</i>	
Grapefruit	<i>Citrus X paradisi</i>	
Rangpur lime	<i>Citrus X limonia</i>	
Troyer citrange	<i>X Citroncirus webberi</i>	
Savage citrange	<i>X Citroncirus webberi</i>	
Cleopatra mandarin	<i>Citrus reticulata</i>	
Rusk citrange	<i>X Citroncirus webberi</i>	
Sunki mandarin	<i>Citrus reticulata</i>	
Sweet lemon	<i>Citrus limon</i>	
Trifoliolate orange	<i>Poncirus trifoliata</i>	
Citrumelo 4475	<i>Poncirus trifoliata X Citrus paradisi</i>	
Ponkan mandarin	<i>Citrus reticulata</i>	
Sampson tangelo	<i>Citrus X tangelo</i>	
Cuban shaddock	<i>Citrus maxima</i>	
Sweet lime	<i>Citrus aurantiifolia</i>	High
Stone fruit		
		Low
Almond	<i>Prunus dulcis</i>	
Myrobalan plum	<i>Prunus cerasifera</i>	
Apricot	<i>Prunus armeniaca</i>	
Marianna plum	<i>Prunus domestica</i>	
Shalil peach	<i>Prunus persica</i>	High

1/ Adapted from Maas (1990).

(d) Leaching for salinity control

(1) Salt balance and leaching

Where salinity is a hazard, the only economical means of salt control is to ensure a net downward flow of water through the crop root zone over time. In this case, the normally defined net irrigation requirement must be expanded to include an additional increment of water for leaching. The leaching requirement is the minimum fraction of the total applied and infiltrated water (irrigation plus precipitation) that must pass through the crop root zone to prevent a reduction in yield from excessive accumulation of salts (USDA 1954 and ASCE 1990).

Leaching occurs whenever the infiltrating part of the irrigation and rainfall exceeds the crop evapotranspiration and the water storage capacity of the soil. In humid regions precipitation is normally sufficient to adequately flush salts from the crop root zone. In arid regions additional irrigation water must be applied to assure adequate leaching. Depending upon the degree of salinity control required, leaching may occur continuously or intermittently at intervals of a few months to a few years.

Where a shallow water table exists, water may flow upward from the ground water resulting in poor drainage and preventing the export of salt from the root zone. This situation can be tolerated temporarily, but cannot be continued indefinitely. Upward flow and drainage may take place alternately during the year. Typically, drainage takes place in the winter and early in the irrigation season, when the crop evapotranspiration rates are low and rainfall or irrigation water applications are high. Upward flow often takes place late in the irrigation season when water requirements are high and rainfall and irrigation amounts are insufficient. If upward flow continues without sufficient leaching, soil salinity will ultimately reduce crop evapotranspiration so much that the crop dies. Temporary use of soil water beyond that normally removed between irrigations or from shallow ground water is a good water management strategy. However, where salinity is a hazard a net downward flow of water through the root zone is needed to sustain crop productivity.

Once salts have accumulated to the maximum tolerable limit for the crop under a given set of conditions, any salt added with subsequent irrigation must be

balanced by a similar amount removed by leaching or salt precipitation to prevent a loss in yield. Two quantities generally are used to establish the leaching requirement:

- The salt concentration of the applied water.
- The salt tolerance of the crop (table 2–34).

The average salt concentration of the applied water can be calculated as a volume weighted value based upon the amounts of irrigation and precipitation. The crop salt tolerance, however, is more difficult to evaluate and has traditionally been established on a relative basis by measuring yields where water of varying salt concentration has been applied at relatively large leaching fractions (typically approaching 0.5). In some areas the electrical conductivity of the irrigation water varies throughout the growing season. A weighted average should be used to calculate irrigation requirements for salinity control in these areas.

(2) Leaching requirement

The most common method of estimating the leaching requirement uses a steady state salt-balance model. Hoffman, et al. (1990) and Rhoades and Loveday (1990) have defined the leaching fraction (L_f) for steady state conditions to be:

$$L_f = \frac{D_d}{D_a} = \frac{EC_{aw}}{EC_d} \quad [2-71]$$

where:

- D_d = the depth of drainage water per unit land area (in)
- D_a = the depth of infiltrated water including both irrigation and precipitation (in)
- EC_{aw} = the electrical conductivity of the applied water, irrigation plus precipitation (mmho/cm)
- EC_d = the electrical conductivity of the drainage water (mmho/cm)

By varying the fraction of applied water that percolates through the root zone, the concentration of salts in the drainage water and either the average or the maximum salinity of soil water in the crop root zone (saturated-soil extract) can be maintained below the desired level. The leaching requirement (L_r) is defined as the minimum leaching fraction needed to prevent yield reduction and can be defined as:

$$L_r = \frac{EC_{aw}}{EC_d^*} \quad [2-72]$$

where:

EC_d^* = the maximum value of the electrical conductivity of the drainage water without reducing crop yields

Inherent in equations 2-71 and 2-72 are the assumptions that no salts are precipitated, dissolved, or removed by the crop. Further, uniform areal infiltration of applied water and uniform evapotranspiration are assumed. Because the electrical conductivity of water is generally a reliable index of total salt concentration, it is often used to estimate the leaching requirement. Several empirical models have been used to relate EC_d^* to some readily available soil salinity value. Several of these empirical methods are given in table 2-39.

Water flowing into and out of the root zone rarely reaches a truly steady state. Thus the amount of salt in water stored in the root zone fluctuates continually. The goal of water management is to maintain the salinity within limits that neither allow excess drainage nor reduce crop growth. Nevertheless, a steady state analysis can provide an estimate of the extra irrigation water needed to maintain a favorable salt balance in the soil.

Table 2-39 Estimates of the electrical conductivity of drainage water for determination of the leaching requirements^{1/}

Reference	Method used to estimate EC_d^* in equation 2-72
Bernstein, 1964	$EC_d^* = EC_e$ where yield is reduced 50%
van Schilfgaarde, et al. 1974	$EC_d^* = EC_e$ where roots can no longer extract water
Rhoades, 1974	$EC_d^* = 5 EC_t - EC_i$
Hoffman and van Genuchten, 1983	Figure 2-33
Rhoades and Loveday, 1990	Figure 2-33

^{1/} EC_e = Electrical conductivity of the saturated-soil extract (mmho/cm).

EC_t = Crop salt tolerance threshold defined in equation 2-70 and values given in table 2-34 (mmho/cm).

EC_i = Electrical conductivity of the irrigation water (mmho/cm).

EC_d^* = Maximum value of the electrical conductivity of the drainage water without reducing crop yield (mmho/cm).

Procedures used to estimate the amount of drainage required to control leaching combine the above definition of leaching requirement (equation 2-73) and the soil-water balance. With soil-water conditions relatively high (normal irrigation scheduling practices), even small precipitation events can be effective in leaching excess salts. Under arid conditions with little rainfall, the combination of these two equations is straight forward.

However, in areas where growing season precipitation contributes substantially to the crop water requirements or off-season rainfall is a significant part of the leaching fraction, the procedure becomes more complicated.

The soil-water balance is used to determine the annual depth of irrigation water required. Over the course of the season, the beginning and ending soil-water balance is generally about the same when irrigation practices are used that refill the crop root zone each irrigation. With this assumption and the restriction that upward flow should not be included as a net water contribution in areas where salts are leached (i.e., adequate drainage), the amount of excess irrigation water required can be estimated. Under arid conditions, the following method is used to estimate the additional water contribution needed for leaching. The net irrigation requirement as a function of the leaching requirement is:

$$L_f = \frac{D_d}{D_a} = \frac{EC_{aw}}{EC_d} \quad [2-73]$$

$$L_z = \frac{EC_{aw}}{EC_d^*} \quad [2-74]$$

$$F_n = \frac{ET_c}{(1 - L_r)} \quad [2-75]$$

$$F_g = \frac{F_n}{E_a} \quad [2-76]$$

where:

F_n = The net irrigation requirement (in)

F_g = The gross irrigation application (in)

ET_c = The seasonal crop evapotranspiration (in)

L_r = The leaching requirement

E_a = The irrigation application efficiency (see section 623.0209 for definition of the irrigation application efficiency)

The leaching requirement (L_r) used in equation 2-75 is calculated from figure 2-33. The ratio of the electrical conductivity at the crop tolerance threshold EC_t (table 2-34) to the electrical conductivity of the applied water is calculated first. In this case, $EC_{aw} = EC_i$ as there is no rainfall. The net irrigation requirement can then be calculated using equation 2-75 and the gross irrigation requirement with equation 2-76 as shown in example 2-21.

Under growing conditions where significant precipitation occurs and must be included in the water balance, the following methods are recommended to determine the net irrigation requirement. In this case the electrical conductivity of the applied water must include the effect of rainfall. Determining the leaching requirement involves iteration because the leaching requirement depends upon the irrigation depth, and the irrigation depth is unknown.

Figure 2-33 Prediction of leaching requirement based on crop tolerance and water salinity (adapted from Hoffman and van Genuchten 1983)

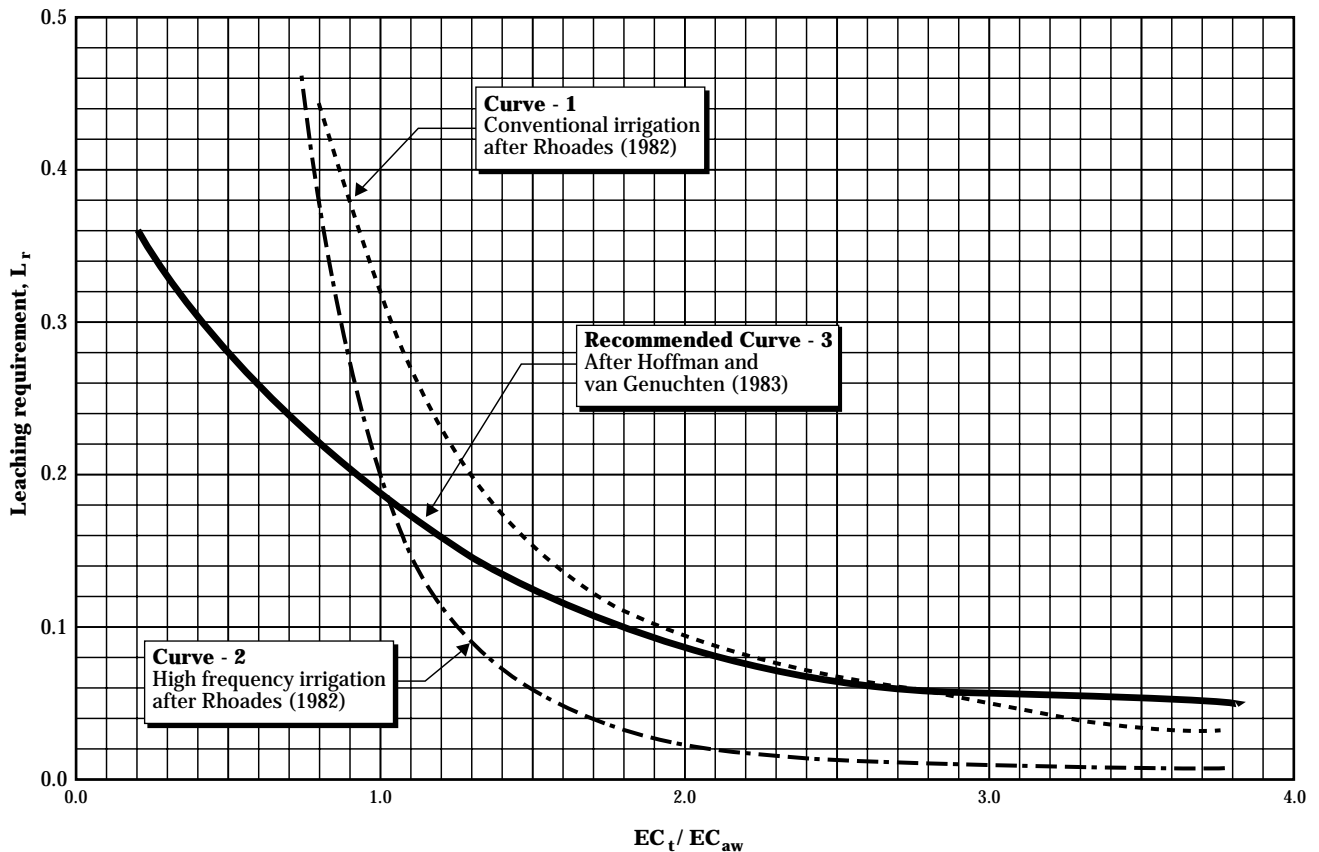

The leaching requirement can be calculated by combining the equations for the soil-water balance and salt balance, giving:

$$F_i = \frac{ET_c}{1 - L_r} - P_{net} \quad [2-77]$$

where:

F_i = The irrigation requirement (depth) that must infiltrate if all the infiltrated precipitation contributes to meeting crop evapotranspiration (in)

P_{net} = The average net annual precipitation that contributes to leaching

P_{net} can be estimated by:

$$P_{net} = P_a - SP_a - E_{os} \quad [2-78]$$

where:

P_a = The average annual rainfall (in)

SP_a = The average annual surface runoff (in)

E_{os} = The average surface evaporation in the nongrowing season (in)

The average electrical conductivity of the applied water (EC_{aw}) can be calculated from:

$$EC_{aw} = \frac{EC_i F_i}{(F_i + P_{net})} \quad [2-79]$$

Example 2-21 Leaching requirement

Given: Irrigated area is in an arid location where rainfall is negligible. Tomatoes will be grown. The irrigation water has an $EC_i = 2$ mmho/cm. The seasonal evapotranspiration for tomatoes is 24 inches. Application efficiency is estimated to be 80 percent.

Required: Determine the leaching requirement and gross irrigation needed for this site.

Solution: L_r is a function of $\frac{EC_t}{EC_{aw}}$ (figure 2-33, curve 3)

Here, $EC_{aw} = EC_i$ and $EC_t = 2.5$ mmho/cm for tomatoes (table 2-34), so

$$\frac{EC_t}{EC_{aw}} = \frac{2.5 \text{ mmho / cm}}{2.0 \text{ mmho / cm}} = 1.25$$

From figure 2-33, $L_r \cong 0.15$

Then from equation 2-75:

$$F_n = \frac{ET_c}{1 - L_r} = \frac{24}{1 - 0.15} = 28.2 \text{ in}$$

Compute the gross irrigation requirement using equation 2-76:

$$F_g = \frac{F_n}{E_a} = \frac{28.2 \text{ in}}{0.8}$$

$$F_g = 35.2 \text{ in}$$

where:

EC_i = The electrical conductivity of the irrigation water

This equation assumes that the precipitation does not contain dissolved salts.

After the depth of irrigation that must infiltrate has been determined using equation 2-77, the following equation can be used to calculate the gross irrigation requirements:

$$F'_g = \frac{F_i}{(1 - F_{ro})} \quad [2-80]$$

where:

F'_g = The gross irrigation requirement to meet the salinity requirements (in)

F_{ro} = The fraction of the gross irrigation that does not infiltrate, decimal fraction

The value of F_{ro} is estimated from local experience and is a function of the type of irrigation system (sprinkler, border, furrow).

The irrigation requirement determined from the salinity balance and crop yield threshold (F_i in equation 2-77) is the depth of irrigation that must infiltrate to maintain a salt balance resulting in no yield reduction. It is not the net irrigation requirement. If the primary water losses during irrigation occur above the soil surface (because of evaporation, drift, or runoff), then the depth infiltrated is nearly equal to the net irrigation requirement. However, with some systems, significant amounts of deep percolation occur even when not trying to leach salts. This creates a problem when estimating the gross irrigation requirement. A method of predicting the gross irrigation requirement is to estimate the fraction of the gross application that does not infiltrate, then calculate the gross application using equation 2-80.

Equation 2-80 cannot be used without considering the seasonal water balance and the type of irrigation system. For example, a system could have such large deep percolation losses that adequate leaching occurs with a smaller gross irrigation than that needed to supply the seasonal evapotranspiration needs. The gross irrigation requirement should be computed

based on both the seasonal water balance and the salt balance. The larger of the two gross irrigation amounts would then be the seasonal gross irrigation requirement.

The seasonal irrigation requirement to meet crop water needs is given by:

$$F_g = \frac{(ET_c - P_e)}{E_a} \quad [2-81]$$

where:

F_g = Seasonal gross irrigation requirement (in)

ET_c = Seasonal crop evapotranspiration (in)

P_e = Growing season effective precipitation (in)

E_a = Irrigation application efficiency, decimal fraction (see section 623.0209 for definition and values)

The value of average annual runoff (SP_a) used in equation 2-78 must be determined locally. Where local information on evaporation from the soil during the nongrowing season is available, it should be used. If this information is not available, the information in figure 2-34 can provide a reasonable estimate. Care and judgment must be exercised in the use of the information in this figure because it is based on average soil and climatic conditions in the upper Midwest.

Because the electrical conductivity of the precipitation is essentially zero, a weighted average of the electrical conductivity of all water entering the soil must be used. This requires the use of a trial and adjustment procedure to determine the average annual leaching requirement. The trial and adjustment procedure is illustrated in the calculations in example 2-22.

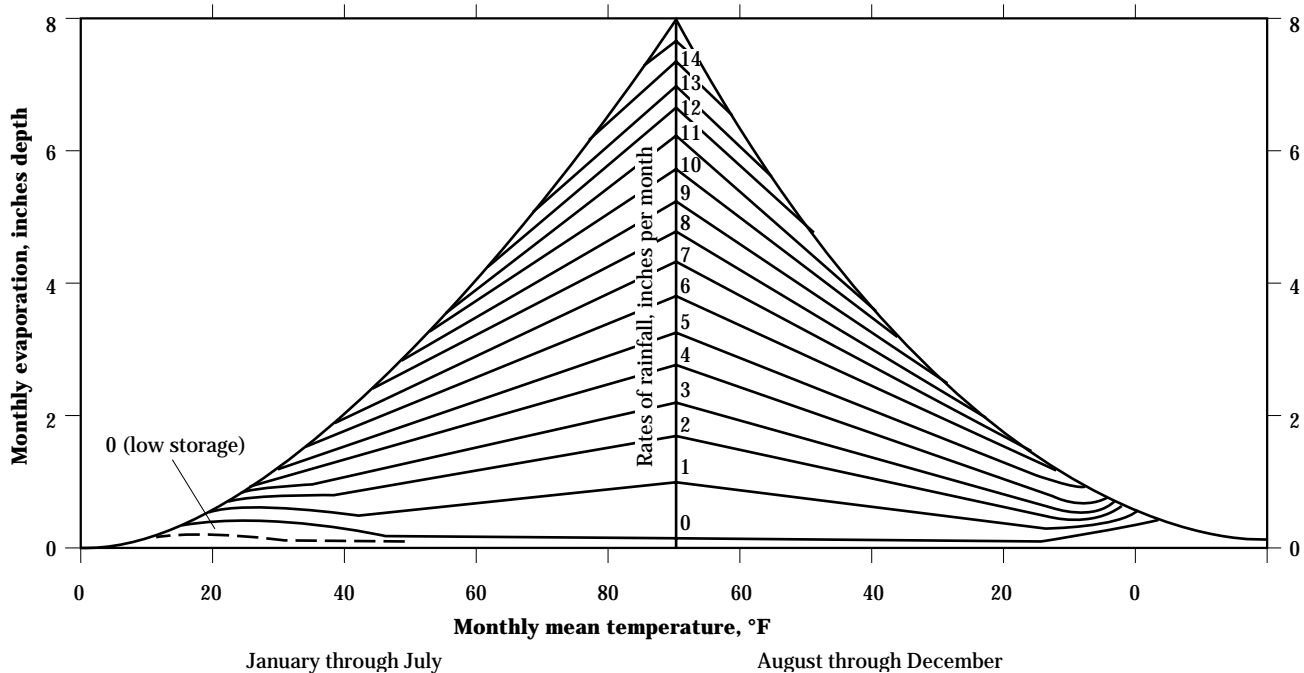
Figure 2-34 Evaporation from land areas for various temperatures and rates of rainfall**Example 2-22** Leaching requirement calculations**Procedure to calculate leaching and gross irrigation requirements**

1. Estimate L_r with figure 2-33 using the ratio EC_t/EC_i to that for EC_t/EC_{aw} .
2. Calculate F_i from equation 2-77.
3. Calculate EC_{aw} from equation 2-79.
4. Calculate EC_t/EC_{aw} and using figure 2-33 (curve 3) estimate a new value of L_r .
5. Repeat steps 2 through 4 until the value of L_r does not change.
6. Compute gross irrigation required (F'_g) for salinity control using equation 2-80.
7. Compute gross irrigation required (F_g) for crop water use from equation 2-81.
8. Select the largest value for the gross irrigation from steps 6 and 7.

Given:	Corn grown in Colorado	
	Seasonal consumptive use (ET_c)	= 24.8 inches
	Average annual precipitation (P_a)	= 11.2 inches
	Average growing season precipitation (P_l)	= 8.0 inches
	Average annual precipitation surface runoff (SP_a)	= 1.0 inches
	Average growing season effective precipitation (P_e)	= 6.0 inches
	Surface evaporation in non-growing season (E_{os})	= 2.5 inches
	Electrical conductivity of irrigation water (EC_i)	= 3.0 mmho/cm

Example 2-22 Leaching requirement calculations—Continued

Salt tolerance threshold of corn (EC_t from table 2-34) = 1.7 mmho/cm
 Percent of gross irrigation that does not infiltrate (F_{ro}) = 10%
 Irrigation efficiency = 70% ($E_a = 0.7$)

Find: The average annual gross irrigation requirement including the required leaching needs.

Calculation:

A. Determine the leaching requirement (L_r).

1. Use EC_t/EC_i to obtain an initial estimate of L_r ;

$$\frac{EC_t}{EC_i} = \frac{1.7}{3.0} = 0.57$$

from figure 2-33, $L_r \cong 0.28$

2. Calculate F_i from equation 2-77 and P_{net} from equation 2-78:

$$P_{net} = P_a - SP_a - E_{os}$$

$$P_{net} = 11.2 - 1.0 - 2.5 = 7.7 \text{ in}$$

$$\text{and } F_i = \frac{ET_c}{1 - L_r} - P_{net} = \frac{24}{1 - 0.28} - 7.7 = 26.7 \text{ in}$$

3. Calculate EC_{aw} using equation 2-79

$$\begin{aligned} EC_{aw} &= \frac{EC_i F_i}{(F_i + P_{net})} \\ &= 3.0 \frac{(26.7)}{(26.7 + 7.7)} = 2.33 \text{ mmho / cm} \end{aligned}$$

4. Calculate EC_t/EC_{aw}

$$\frac{EC_t}{EC_{aw}} = \frac{1.7}{2.33} = 0.73$$

and from figure 2-33 (curve 3), $L_r \cong 0.24$.

5. Go to step 2 and repeat calculations, new F_i value:

$$F_i = \frac{ET_c}{1 - L_r} - P_{net} = \frac{24.8}{1 - 0.24} - 7.7 = 24.9 \text{ in}$$

6. New EC_{aw} value:

$$EC_{aw} = 3.0 \frac{(24.9)}{(24.9 + 7.7)} = 2.29 \text{ mmho / cm}$$

Example 2-22 Leaching requirement calculations—Continued

7. Determine ratio of EC_t to EC_w :

$$\frac{EC_t}{EC_{aw}} = \frac{1.7}{2.29} = 0.74$$

and from figure 2-33 (curve 3), $L_r \cong 0.24$.

8. Stop. L_r is about the same as that in step 4. Thus, $F_i = 24.9$ inches. Generally, the iteration only requires a few cycles.

B. Calculation of the gross irrigation requirement.

Equation 2-80 is used to calculate the gross irrigation requirement for salinity control:

$$F'_g = \frac{F_i}{(1 - F_{ro})}$$

$$F'_g = \frac{24.9}{(1 - 0.1)}$$

$$F'_g = 27.7 \text{ in}$$

Without salinity control, the gross irrigation is calculated by equation 2-81:

$$F_g = \frac{(ET_c - P_e)}{E_a}$$

$$F_g = \frac{(24.8 - 6)}{0.7} = 26.9 \text{ in}$$

Thus, in the example, salinity control determines the gross irrigation requirements. Note that for this example the gross irrigation required for salinity control is only slightly above the "traditional" gross irrigation.

If soil-water depletions are replaced frequently, the plant roots near the soil surface will be exposed to water that has an electrical conductivity near that of the applied water rather than an “average” root zone value. Crop yields are, therefore, usually more affected by the irrigation water salinity level than by the soil-water salinity in the lower part of the root zone; particularly if the minimum leaching requirement is maintained under high frequency irrigation (see fig. 2–33, curve 2). Research findings (van Schilfgaarde, et al. 1974) indicate that leaching fractions generally can be much lower (in the range of 0.05 to 0.20) than those previously recommended by the U.S. Salinity Laboratory staff (USDA 1954). These reduced requirements contrast with estimated leaching fractions ranging from 0.30 to 0.60 for irrigated areas of the Western United States (Jensen 1975). In most areas this leached water percolates to drains or a shallow ground water zone where it ends up in return flow drainage.

Precise attainment of minimum leaching fractions is a difficult problem (van Schilfgaarde, et al. 1974). For example, a 1 percent error in estimating evapotranspiration can cause a 20 percent change in leaching if the leaching target is 5 percent. Willardson and Hanks (1976), in leaching tests with a solid set sprinkler system that applied water uniformly, concluded that it is unrealistic to expect to maintain average leaching fractions less than 0.10 to 0.15 on a field scale.

From a practical standpoint, the management approach to control salinity is more critical than an accurate estimation of the leaching requirement. If the management objective is to apply the calculated L_r to the 10 or 20 percent of the field that receives the least depth of water, the average L_r over the entire field will be considerably more than the estimated L_r . Jensen (1975) showed that, depending on the distribution uniformity and the management objectives, using a given L_r of the field receiving the least amount of water would produce an average L_r for the field three to five times higher than the given L_r , even for systems that have a very high uniformity. Also, because of the uncertainty in estimating the required depth of water to refill the profile, the achievement of a desired L_r over a field is difficult in practice. Periodic monitoring of root zone salinity is therefore unavoidable to verify the maintenance of salt balance. Irrigating without leaching for several seasons while monitoring the soil salinity status and then leaching periodically is often more practical.

To achieve the desired degree of leaching, either natural or artificial drainage must be adequate to convey the drainage water (leachate) away from the root zone. Moreover, if a water table is present, it must be controlled at an appropriate depth to enable leaching and to prevent any appreciable upward flow (with its salt) into the root zone.

The salt balance is affected by precipitation reactions involving slightly soluble salts, such as gypsum, carbonates, and silicate minerals. Consequently, the amount of salt leached below the root zone may be less than that applied. When irrigation water has a concentration of salt more than 100 ppm to 200 ppm and if leaching fractions are less than 0.25, some salts precipitate in the root zone and become stored in the soil profile. When irrigation water has a moderate amount of salt, such as the 800 ppm that occurs in the lower reaches of the Colorado River, and leaching fractions are below 0.25, salts precipitated in the soil profile exceed the amount weathered (Hoffman 1990). Salt precipitation may be a significant part of calculating the salt balance when the leaching fraction is small.

(3) Leaching frequency

High concentrations of salt in the lower part of the crop root zone can be tolerated with minimal effects in crop yield provided the upper part is maintained at a relatively low salt content. Plants compensate for reduced water uptake from the highly saline zone by increasing water uptake from the zone low in salinity. Although this compensation can occur without yield reduction, questions often asked are how much salt can be stored in the root zone before leaching is required and how frequently must extra water be applied to provide for leaching.

Some irrigation water has salinity at reduced levels such that even without leaching, many irrigations can be applied before salinity accumulates to levels detrimental to crop yield. This delay in leaching is dependent on crop salt tolerance. The more tolerant the crop, the longer the delay.

The salt tolerance of many annual crops increases as the growing season progresses. This suggests that if soil salinity levels are low enough at the beginning of the irrigation season for early seedling growth and adequate amounts of low-salt water are applied for evapotranspiration, soil salinity can be permitted to

increase throughout the irrigation season. For the next crop, rainfall either singly or in combination with dormant season or preplant irrigations can replenish soil water and leach accumulated salts to permit irrigation the next season without the need for further leaching. An important exception to this process occurs for perennial crops, like trees, that form their buds for the next year during the latter half of the irrigation season.

If irrigation water is saline, rainfall and out-of-season leaching may not be sufficient and leaching during the irrigation season may be required to prevent yield loss. The key factor is that leaching is not required until accumulated soil salinity surpasses the salt tolerance threshold for the crop. This certainly does not mean that leaching is relatively unimportant. The leaching requirement must be satisfied. Leaching can be done each irrigation or less frequently, such as seasonally or at even longer intervals, provided soil salinity is maintained below the salt tolerance threshold if yield losses are to be avoided. In many instances, inefficiencies of water application are compensated for by applying more water throughout the field. Where the leaching requirement is low, as with relatively nonsaline water, these additional applications frequently provide sufficient extra water for leaching.

(4) Influence of irrigation method

The irrigation method used to apply water affects the way salts accumulate in the crop root zone. Irrigation systems may not apply water uniformly over the entire irrigated area. Some irrigation methods apply water over the entire area by flooding and sprinkling. Furrow irrigation systems, porous or multiemitter trickle and subsurface irrigation systems apply water along lines. Point sources of irrigation water include microbasins and trickle systems that have widely spaced emitters. Soil salinity profiles beneath each method of irrigation may differ because of nonuniform water application over time and space.

Irrigation systems that apply water uniformly over the entire area typically result in a relatively uniform increase in salinity with soil depth to the bottom of the root zone, provided that net leaching is downward. If the field is inadequately drained where evaporation from the soil surface is high, soil salinity, particularly near the soil surface, increases with time between irrigations. Salt accumulation can also vary widely

within a given field if soil hydraulic conductivity, uniformity of water application, or crop water extraction differ.

With surface irrigation methods (basin, borders, and furrow), the depth of applied water entering the soil varies with location in the field and depends on the soil infiltration rate and the time available for infiltration. Differences in the infiltration rate can be caused by land slope, degree of compaction, textural changes, and soil chemistry. The intake opportunity time may also vary. The upper end of the field nearest the water supply generally has water on the surface longer than does the lower end. High spots in the field also receive less water, and low spots more. Proper design and management of surface irrigation systems are critical when salinity is a problem.

A properly designed sprinkler system applies water with good uniformity and at application rates low enough to prevent runoff. If properly managed, it can result in adequate and uniform leaching. On sensitive crops, however, sprinklers can cause leaf burn when salts (sodium and chloride) concentrate excessively on the surface of leaves.

For buried trickle lines, the salt distribution within the soil profile is moved laterally and vertically. Typically, the salts concentrate in isolated pockets at the soil surface midway between line sources. A second, deep zone of accumulation whose location depends on the degree and efficiency of leaching also forms. The area directly beneath the line source is leached the most, with the size of the area determined by the rate and frequency of irrigation and the water extraction pattern of the crop. This type of soil salinity profile is common of many furrow and micro irrigation systems for row crops.

The salt distribution from point irrigation sources increases radically in all directions below the soil surface with the shape dependent on the rate of water application. In fine-textured soils, and particularly in layered soils, more water can move horizontally than vertically as the rate of application increases. This results in a relatively shallow depth of salt accumulation. For tree crops irrigated with several drip emitters per tree, the wetting patterns may overlap, thus reducing the level of salt accumulation midway between emitters under a tree.

Subirrigation, which has been adapted in a few select situations, is accomplished by managing the water table at an elevation to allow upward water movement of water to meet crop evapotranspiration demands. This process tends to concentrate salts on or near the soil surface irrespective of whether the salinity originates from the water or the soil. A similar process takes place with subsurface-trickle irrigation systems. Neither of these irrigation methods provide a means of leaching these shallow salt accumulations. Thus, care must be exercised when using these methods with poor quality water unless the soil is leached periodically by natural rainfall or surface applied water.

(e) Salinity management alternatives

(1) Salinity control

The major objective of improved management under saline conditions is to keep salinity within acceptable limits for germination, seedling establishment, and crop growth and yield while minimizing the salt-loading effects of drainage. Procedures that require relatively minor changes in management are selection of more salt-tolerant crops, additional leaching, pre-plant irrigation, and seed placement. Alternatives that require significant adjustments are changing the method of irrigation, altering the water supply, land-grading, modifying the soil profile, installing artificial drainage, and crop residue management. Ayers and Westcot (1985) and the ASCE Manual "Agricultural Salinity Assessment and Management" (ASCE 1990) give specific recommendations regarding these suggested management practices.

(i) More frequent irrigations—Salts in the soil solution concentrate as water is extracted by the crop. Hence, salt concentrations within the crop root zone are lowest following an irrigation and highest just before the next irrigation. Increasing irrigation frequency decreases the soil-water content variation thereby reducing the range of salt concentrations between irrigations. Maintaining a higher soil-water content provides water for plant use that is at lesser salt concentration. The upper part of the root zone remains relatively low in salinity if the depth applied at each irrigation is adequate to meet the crop water requirements. Frequent irrigations also permit small water applications that minimize surface runoff. Applying more water less frequently may not always be

beneficial because the extra water is often lost to surface runoff or evaporation, which reduces the application efficiency. Frequent applications of a larger depth of water tend to reduce aeration in the soil. Water must pass through the crop root zone to be effective in leaching.

Notwithstanding the above, no improvement in yield under salinity caused by increasing irrigation frequency has been experimentally demonstrated (Bresler and Hoffman 1986). While the evapotranspiration rate does not decrease below its maximum potential until the allowable depletion is reached, the relative importance of the evaporation and transpiration components varies markedly with irrigation frequency. If the surface soil is wetted frequently, the evaporation rate is high even under full canopy conditions. Therefore, under frequent irrigations, the relatively high evaporation tends to concentrate salts in the surface layer, unless the soil is permeable enough to allow any excess water to leach below the root zone. In addition, root water extraction takes place preferentially from the upper soil layers if they are frequently wetted while extraction proceeds in the deeper layers only if the surface layer is allowed to dry excessively. Both processes tend to concentrate salts more in the surface layer under frequent irrigations, counteracting some of the benefits of a less fluctuating soil matric potential.

Thus, the recommendation to irrigate more frequently because of salinity must be tempered by other factors. An exception must be made for the case of micro irrigation, where the localized water applications displace the salts towards the boundaries of the wetted zone, leaving an area under the emitter that always has a higher water content and low salt concentration. Net water movement must be downward as well as laterally away from the plant. Too often micro irrigation systems are shut off during rainfall events, causing salt to move back into the area of plant roots because of the uniform rainfall application.

Increasing the quantity of applied water for salinity control is the only practical measure where a crop is irrigated with saline water. Studies have shown that increasing the seasonal irrigation depth compensates for the increased water salinity, at least up to a point, but the salinity of the irrigation water per se is not reduced (Bresler and Hoffman 1986).

(ii) Crop selection—If saline irrigation water is used, selection of a salt-tolerant crop may be required to avoid yield reductions. Agricultural crops have about a tenfold range in salt tolerance (table 2–34). The selection of a more salt-tolerant crop, however, will not eliminate the need for leaching and for better management practices; but it will reduce the need and amount of leaching. Planting crops earlier in spring or growing cool-season crops where salinity problems are marginal for production may reduce the water requirement sufficiently to attain full production even with rather salt-sensitive crops.

(iii) Additional leaching—Soluble salts that accumulate in excessive amounts in soils must be leached below the crop root zone. The time interval between leachings does not appear to be critical if crop tolerances are not exceeded. Depending on the size of the leaching requirement, leaching can be accomplished with each irrigation, every few irrigations, once yearly, or after even longer intervals, depending on the severity of the salinity problem and crop salt tolerance. An annual leaching during the noncrop or dormant period is often sufficient.

(iv) Preplant irrigation—Salts often accumulate near the soil surface during fallow periods, particularly if the water table is high or winter rainfall is below normal. Under such conditions seed germination and seedling growth can be reduced unless the soil is leached before the seed germinates.

(v) Seedbed preparation and seed placement—Obtaining a satisfactory stand of furrow-irrigated crops on saline soils or where saline water is used is often a problem. Growers sometimes compensate for poor germination by planting two or three times as much seed as would normally be required. In other instances, planting procedures are adjusted to ensure that the soil around the germinating seeds is low in salinity. Examples of the effect of bed shapes are shown in figure 2–35.

In furrow-irrigated soils, planting seeds in the center of a single-row, raised bed places the seeds in the area where salts are expected to concentrate. With a double-row, raised planting bed, the seed is placed near the shoulder of the bed and away from the area of greatest salt accumulation. Thus, soil salinity can be minimized at germination compared to single-row

plantings because the water moves the salts away from the seed area toward the center of the ridge.

Alternate-furrow irrigation may help in some cases. If the planting beds are wetted from both sides, the salt accumulates in the top and center of the bed. If alternate furrows are irrigated, however, salts often can be moved beyond the single seed row to the nonirrigated side of the planting bed. Salts may still accumulate, but accumulation at the center of the bed will be reduced. The longer the water is held in the furrow, the lower will be the salt accumulation at the mid-bed seed area. Off-center, single-row plantings on the shoulder of the bed, close to the water furrow, have also been used as aids to germination under saline conditions. Double-row planting under alternate-furrow irrigation is not recommended because salt will accumulate on the edge of the bed away from the irrigated furrow.

Increasing the depth of water in the furrow of single- or double-row plantings, can also improve germination in salt-affected soils. Salinity can be controlled even better by using sloping beds, with the seeds planted on the sloping side just above the water line. Irrigation is continued until the wetting front has moved well past the seed row. During the first cultivation after planting, the sloped bed can be converted to a conventional raised bed.

(vi) Changing irrigation method—Gravity irrigation methods, such as basin, furrow, or border methods, generally are not sufficiently flexible to permit changes in frequency of irrigation or depth of water applied per irrigation and still maintain high levels of application efficiency. For example, with typical furrow irrigation, it may not be possible to reduce the depth of water applied below 3 to 4 inches per irrigation. As a result, irrigating more frequently might improve water availability to the crop, but might also waste water. If a change to more frequent irrigations is advisable, a sprinkler, drip, automated surface irrigation system may be required.

With adequate system design and management and by adjusting the duration and frequency of application, sprinklers can readily apply the depth of water to supply the crop's water requirement plus leaching. Sprinklers are sometimes used during germination and early seedling growth when some crops may be par-

ticularly sensitive to salinity, high temperatures, soil crusting, or a combination of these. Where the water quality is poor, yields may be better if drip irrigation is used because of the continuously high soil-water content and daily replenishment of water lost by evapotranspiration.

(vii) Changing water supply—Changing to a water supply of better quality is a simple solution to a salinity problem, but alternative supplies are not always available. If water of two different qualities is available, a blend may reduce the salinity hazard of the more saline water. However, this practice is not generally recommended (Rhoades 1990). Mixing water supplies may reduce the total volume of the water supply that can be consumed by salt-sensitive crops.

The amount of such reduction depends upon the relative volumes and concentrations of the receiving water and wastewater and the tolerances of the crops to be irrigated. Therefore, the merits of blending should be evaluated on a case-by-case basis.

(viii) Land grading—In some instances fields are not graded accurately enough to permit satisfactory water distribution by surface irrigation. High spots in the field reduce water intake by the soil and may lead to salinity problems. As an alternative, sprinkler or drip irrigation can be used without precise grading.

Figure 2-35 Pattern of salt buildup as a function of bed shape and those effects on the germination of seeds placed at different locations on the beds (adapted from Bernstein, et al. 1955)

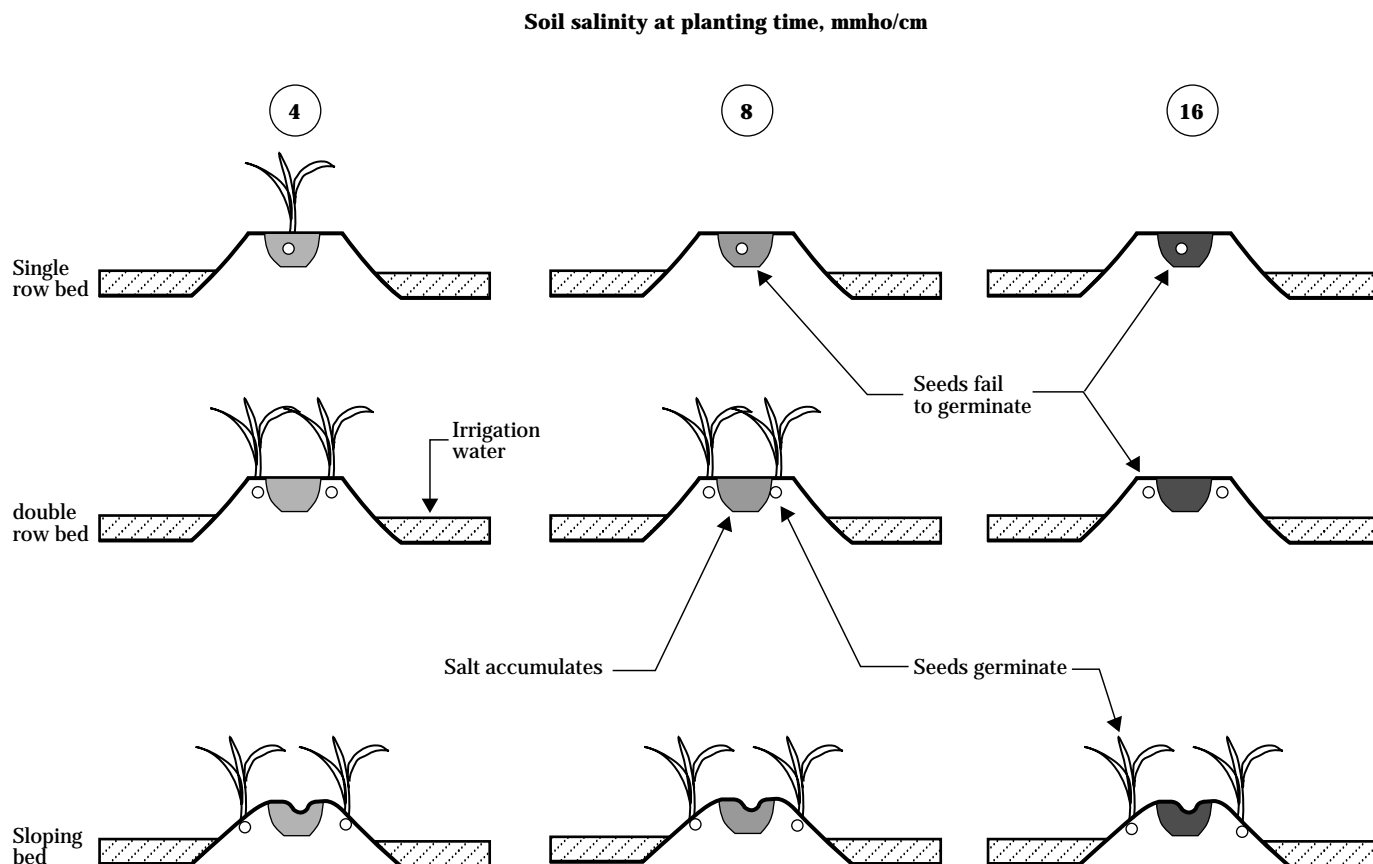

(ix) Soil profile modification—If the soil has layers that impede or inhibit root and water penetration, water management and salinity control can be simplified if the layers are fractured, destroyed, or at least rendered more permeable to roots and water. Subsoiling and chiseling may improve internal drainage of the soil profile, but results are often short lived. Deep plowing, however, often results in permanent improvement in some soils. It may bring up salt from the subsoil and create salinity problems. The physical and chemical properties of the entire profile should be considered before deep plowing is recommended. It generally is performed after land grading, but before leaching. This is a drastic treatment and often necessitates growing a salt-tolerant crop, such as barley, the first year after deep plowing, and then regrading.

The inhibiting layer may be caused by soil compaction from farming equipment and tillage operations. Where an inhibiting layer exists, it must be broken up by subsoiling or chiseling. It generally is possible to decrease the continuing severity of the problem by reducing farming operations that are not absolutely essential to produce the crop.

Salt and tillage break down soil aggregates and reduce the soil pore space, which reduce water movement and root development. The addition of organic matter to arid soils improves biological activity and water movement and results in a better soil condition. Reducing soil compaction and adding organic matter to arid soils are long-term beneficial modifications to the soil profile.

(x) Drainage—Lack of adequate surface or subsurface drainage greatly complicates water management for salinity control. Land grading and improved surface drainage systems may be required to alleviate poor surface drainage because flat or uneven slopes cause ponding and waterlogging. Subsurface drainage may be impeded by a layer that is slowly permeable to water. Subsurface drainage problems may also arise because of over-irrigation, seepage of water from higher elevations, or leakage from canals. A water table less than 4 to 6 feet below the soil surface may cause salts to accumulate in the root zone if net downward water movement is not maintained. Salt moves with the water to the soil surface and is deposited when the water evaporates. This can cause salinity problems even with good quality irrigation water. The salinity problem is solved by first improving drainage, then leaching.

(2) Management of infiltration problems

Both chemical and physical methods can be used to improve soil permeability reduced by excess sodium in the soil. Beneficial chemical methods include using soil or water amendments and blending or changing the irrigation water supply. Physical methods that may increase the amount of water penetration are increasing the irrigation frequency, cultivating or deep tilling, extending the duration of each irrigation, changing the grade or length of run for surface irrigations, collecting and recirculating surface runoff, using sprinklers to match the rate of water application to the soil infiltration rate, and using organic residue.

Amendments may be effective where the soil hydraulic conductivity has been decreased by the use of irrigation water low in salinity ($EC_i < 0.5$ mmho/cm) or by the presence in the soil or water of excessive amounts of sodium, carbonate, or bicarbonate (a high SAR). Amendments will not be useful if low hydraulic conductivity is caused by soil texture, compaction, water-restricting layers, or high ground water. Where low infiltration rates are caused by a high soil exchangeable sodium percentage (ESP), improved permeability should result if either the sodium concentration in the irrigation water is decreased or the concentrations of calcium, magnesium, or both, are increased. An inexpensive process or chemical is not available for removing sodium from irrigation water. Calcium, however, can be added to the soil or the water to decrease the sodium to calcium ratio. The source of calcium may be direct (gypsum) or indirect from acid or acid-forming substances (sulfuric acid or sulfur) that dissolve calcium from lime in the soil. Field trials should always be conducted to determine if results are sufficiently beneficial to justify the expense.

Where the permeability problem results primarily from a low water infiltration rate, granular gypsum may be more effective if left on the soil surface or mixed to a shallow soil depth, rather than worked deeper into the soil. Applying gypsum in the irrigation water generally requires less gypsum per unit area than that for soil applications. Water applications of gypsum are particularly effective for restoring lost permeability caused by low-salinity water, but the gypsum becomes less effective as the salinity of the irrigation water increases because it normally contains gypsum.

Sulfur may also be effective as a soil amendment for correcting a sodium problem (high ESP) if the soil

contains lime. The sulfur must first be oxidized to sulfuric acid by soil bacteria, which in turn reacts with soil lime to produce gypsum. The oxidation process is slow and requires a warm, well aerated, moist soil. Because sulfur is not water soluble and must react with soil lime, it is not normally effective as an amendment for improving water infiltration. Sulfur has been used successfully on calcareous soils that have an extremely high ESP level.

Sulfuric acid is used occasionally as an amendment and can be applied either to the soil or to the irrigation water. It reacts rapidly with soil lime because oxidation is not required. However, it is highly corrosive and dangerous to handle. If sulfuric acid is not handled properly, it may damage concrete pipes, steel culverts, checkgates, and aluminum pipes.

Fertilizer that has filler material can be used as a beneficial amendment. Other amendments may also be effective, but they are not extensively used because of their relatively high costs. Ayers and Westcot (1985), the U.S. Salinity Laboratory staff (USDA 1954) and ASCE (1990) give specific information on chemical methods to manage permeability problems.

Cultivation and deep tillage may increase water penetration, although in most cases they are only temporary solutions. Deep tillage (chiseling, subsoiling) can improve water penetration, but because many permeability problems are at or near the soil surface, the shallow soil soon reverts to its previous condition. Where slow infiltration is caused by a surface crust or a nearly impermeable soil surface, cultivation can roughen the soil and open cracks and air spaces that slow the surface flow of water and, for a time, greatly increase infiltration.

Long-term benefits of desired infiltration and permeability in the soil profile include:

- Reduce soil inhibiting layers by decreasing soil compaction from tillage and traffic.
- Add organic matter to improve biological activity, water movement, and maintain a better soil condition.

Extending the duration of each irrigation may increase the amount of irrigation water infiltrating, but aeration, waterlogging, excessive surface runoff, and surface drainage problems may result. The duration of the preplant irrigation could be extended to allow the

soil profile to fill. This irrigation may provide the only opportunity to fill the deeper part of the crop root zone without secondary effects on the growing crop.

Crop residue left on the soil or cultivated into the surface often improves water penetration. For significant improvements in water penetration, relatively large quantities of crop or other organic residues are usually required. Rice hulls, sawdust, shredded bark, and many other waste products have been tried with various degrees of success at rates equal to 10 to 20 percent of the soil by volume. Nutritional imbalances and nitrogen shortages may develop after the use of sawdust, and chloride or potassium toxicity has been noted from the use of rice hulls.

(f) Reclamation of salt-affected soils

Reclamation is discussed separately from other salinity management techniques to emphasize the differences between the relatively continual management procedures required to control salinity and the reclamation procedures required to restore productivity lost because of severe soil salinity or sodicity. The U.S. Salinity Laboratory staff (USDA 1954) and ASCE (1990) give specific recommendations on the reclamation of salt-affected soils. Reclamation may require the removal of excess soluble salts as well as the reduction of soil ESP. The only proven way to reduce the soluble salt concentration in the root zone is leaching. The ESP is more difficult to reduce because sodium ions adsorbed on soil-exchange sites must first be replaced with divalent cations from the soil solution, through a chemical reaction, and then be leached from the root zone. Hence, the reclamation of a sodic soil is a combination of chemical and mass-transfer processes.

(1) Drainage

Reclamation of salt-affected soils by leaching requires adequate drainage because of the large amounts of water that must pass through the soil profile. Natural internal drainage is normally adequate if the soil profile below the crop root zone is permeable and provides sufficient internal storage capacity or if permeable layers are present to provide natural gravity drainage to a suitable outlet. Where such natural drainage is lacking, artificial systems must be installed.

Preventing soil-water accumulation, either on the soil surface or in the plant root zone, requires continuous downward movement of water through the soil. In some cases, this excess water moves away through natural channels, such as porous subsoil strata, and eventually joins streams or rivers. In other cases artificial drains must be installed to make possible a net downward movement of soil water. The objective of drain installation is to lower and control the elevation of the water table. Specific information on the design of drainage systems is given in the SCS National Engineering Handbook.

(2) Removal of soluble salts

The amount of water that must be applied to reclaim a saline soil by leaching depends primarily on the initial soil salinity level and the technique of applying water.

Typically, about 70 percent of the soluble salts initially present in a saline soil profile will be removed by leaching with a depth of water equivalent to the depth of soil to be reclaimed if water is ponded continuously on the soil surface and drainage is adequate. The relationship between the fraction of salt remaining in the profile and the amount of water leaching is shown in figure 2-36.

The amount of water required for leaching soluble salts can be reduced by intermittent applications of ponded water or by sprinkling. Differences in leaching efficiency among these methods primarily result from differences in the effect of molecular diffusion to primary flow channels and by the larger percentage of water flowing through the fine pores and soil mass in the unsaturated case. Leaching efficiency by sprinkling

Figure 2-36 Depth of water per unit depth of soil required to leach a saline soil by continuous or intermittent ponding, or to leach a soil inherently high in boron (adapted from Hoffman 1981)

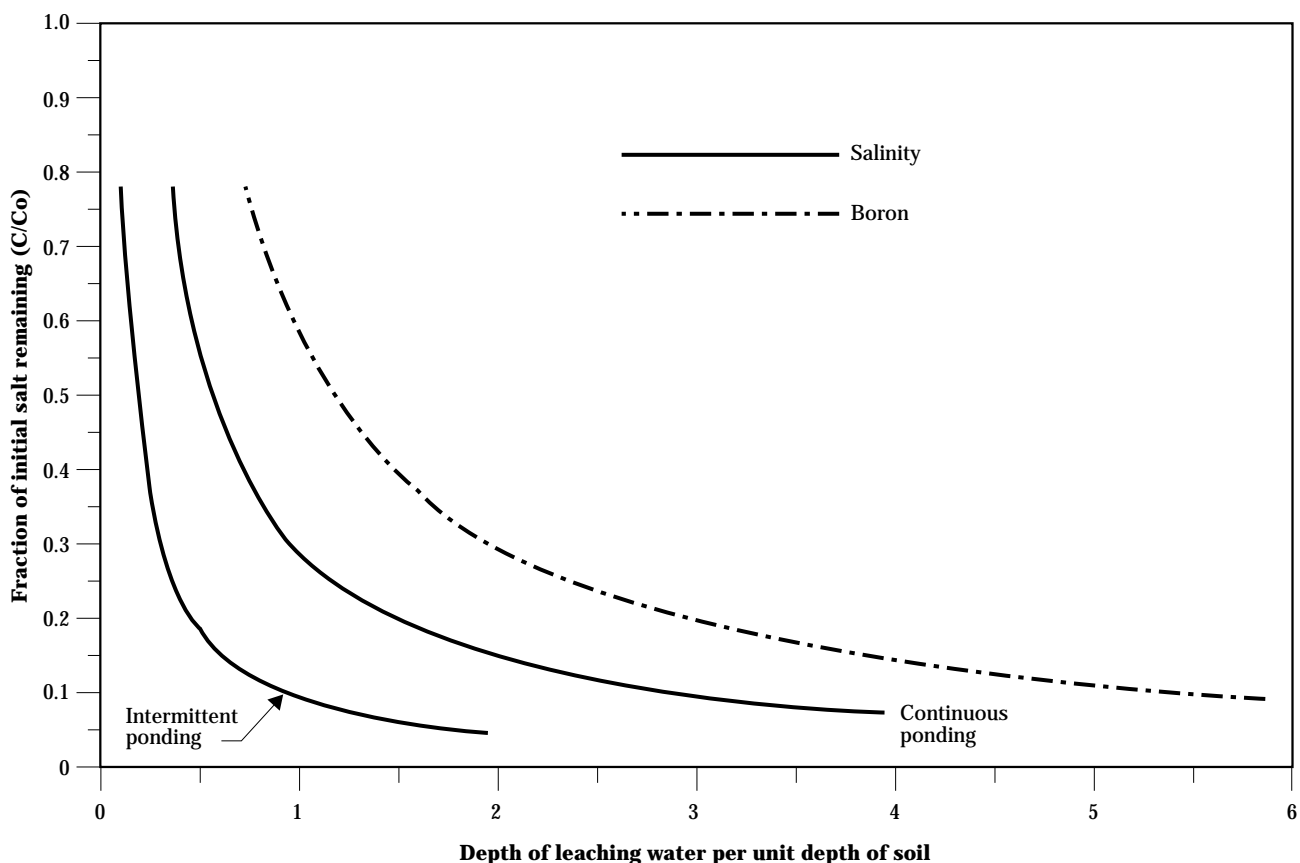

is similar to that for intermittent ponding. Sprinkling has the added advantage over ponding in that precise land leveling is not required. Intermittent ponding or sprinkling may take longer than continuous ponding, but can be accomplished with less water.

Reclamation of salt-affected soils can be enhanced by the presence of plants. If the initial soil salinity is high, the topsoil must be leached before even salt-tolerant plants can be grown. The beneficial effects of plants are not well understood, but probably result from the physical action of plant roots, the increased dissolution of lime in the presence of carbon dioxide evolved from plants, or the addition of organic matter.

Excess boron is generally more difficult to leach than soluble salts because it is more tightly absorbed to soil particles. For soils inherently high in boron, the amount of water required to remove a given fraction of boron is about twice that required to remove soluble salts by continuous ponding. Boron leaching efficiency does not appear to be significantly influenced by the method of water application.

(3) Reclamation of sodic soils

Reclamation is more difficult for sodic soils than for saline soils. Three processes are needed to reclaim a sodic soil:

- An increase in the hydraulic conductivity.
- Leaching of the sodic salts from the system.
- Replacement of sodium by calcium.

During reclamation leaching water must percolate through the soil profile to dissolve and transport the divalent cations to the cation-exchange sites for exchange with the adsorbed sodium.

If sufficient gypsum is not naturally present, any soluble calcium salt can be applied as an amendment to reclaim sodic soils. The application of gypsum, calcium carbonate, or calcium chloride is most common. Sulfur and sulfuric acid are sometimes used to enhance conversion of naturally occurring calcium carbonate to gypsum, which is more soluble than calcium carbonate.

Calcium chloride is much more soluble than gypsum or calcium carbonate. When sufficient gypsum is naturally present in the upper soil profile and when the clay-sized minerals in the soil are of the 1:1 lattice or nonexpanding type (illite, kaolinite, vermiculite),

chemical reclamation can be achieved simply by leaching if hydraulic conductivity is adequate. It may be advantageous in some cases, to superimpose a wetting and drying, freezing and thawing, or crop growth cycle on the chemical reclamation process before the soil is fully reclaimed. This is particularly true if soil permeability has been reduced drastically by exchangeable sodium. The amount of amendment required to reclaim a sodic soil is a function of the soil cation-exchange capacity (CEC), the desired change in ESP, the soil bulk density, and soil depth.

The flow of leaching solution through the profile is essential to the reclamation process. Hydraulic conductivity of a sodic soil is a function of both ESP of the soil and electrolyte concentration of the percolating solution as well as soil pH. Hydraulic conductivity decreases as ESP increases when electrolyte concentration remains constant, and increases as electrolyte concentration increases when ESP remains constant. The functional relationships vary with soil texture and mineralogy. The amount of water that must pass through the profile for chemical reclamation with gypsum depends on the amount of gypsum needed for chemical exchange.

Leaching solutions having low-electrolyte concentrations cause sodic soils to disperse, resulting in a low hydraulic conductivity. Leaching solutions having high-electrolyte concentrations have a flocculating effect on soil particles and cause clay packets to contract. As a result, the higher the salt concentrations of the leaching solution, the higher the hydraulic conductivity. Clay minerals having expanding-type lattices (montmorillonite) influence hydraulic conductivity more than do minerals of the nonexpanding type (illite, kaolinite, vermiculite).

Gypsum, sulfur, and limestone amendments generally are broadcast and then cultivated into the soil. If sulfur is used, leaching should be delayed until the sulfur has oxidized and gypsum has been formed.

If acids or acid-formers are used, alkaline-earth carbonates must be either in or above the sodic layer to ensure that downward percolating water will carry dissolved calcium to the exchange sites. After leaching, the solubility of gypsum in nonsaline, sodic soil is sufficiently low to be of no problem to any but the most salt-sensitive crops. Hence, if hydraulic conductivity is acceptable and sufficient leaching takes place,

crops that are not sensitive to sodium can often be grown during reclamation.

Where soil physical conditions have deteriorated and hydraulic conductivity is so low that the time required for chemical reclamation is excessive, the high-electrolyte method for sodic-soil reclamation may be warranted. This method consists of applying successive dilutions of a high-salt water containing divalent cations. Exchangeable sodium is replaced by divalent cations from the leaching solution, while water penetration is maintained by the flocculating effect of the high-salt water. Soil hydraulic conductivity often is extremely low where clay minerals of the expanding-lattice type (montmorillonite) are in the soil. The high-electrolyte method has also been used to reclaim a slowly permeable, mildly sodic, low-electrolyte soil in a humid environment where hydraulic conductivity and infiltration were increased by 30 to over 100 percent.

The U.S. Salinity Laboratory staff (USDA 1954) and ASCE (1990) give specific procedures and examples for reclaiming sodic soils.

In areas that have salt problems, irrigated agriculture cannot be sustained without adequate leaching and drainage to prevent excessive buildup of salts in the soil profile. Where subsurface drainage systems are installed to improve downward water movement and removal of the required leaching volume, the soluble salts can potentially move to surface water. Some soluble salts in drainage flows have been found to be toxic to waterfowl. Desirable nutrients necessary for plant growth that are also soluble, such as nitrates, are also easily leached out of the root zone.

Where possible, leaching events can be planned when nitrate levels in the soil are low. The leaching requirement for salinity control can be minimized with adequately designed, installed, and operated irrigation delivery and application systems and by monitoring irrigation applications and salinity levels. Drainage-return flows can be intercepted and diverted to other outlets and uses. Drainage flows can be desalted, disposed of through use of evaporation ponds, or used as a supply for applications where brackish water is acceptable, such as the irrigation of high salt-tolerant plants or other industrial uses (ASCE 1990, Doerge 1991).

623.0206 Auxiliary irrigation water requirements

In addition to the evapotranspiration and salinity management requirements, irrigation systems can meet special needs of crops. These secondary uses can often pay high dividends and should be considered in the design of irrigation systems. This section focuses on the water requirements for frost protection, crop and soil cooling, wind erosion control, and the application of chemicals through the irrigation system (chemigation). Water for these uses is generally required for a relatively short duration. The rate and timing of water application is often more important than the volume of water applied.

In some cases the primary and secondary uses for irrigation systems can be accommodated with one irrigation system design. In those cases the management of the system must change to successfully accomplish the secondary objectives. Information in this section describes some of the requirements for the auxiliary uses of an existing irrigation system.

The secondary benefit in some cases requires performance that an existing irrigation system or a system designed to meet evapotranspiration and leaching requirements cannot satisfy. In those cases a second irrigation system may be required. The design of the secondary system will be quite different from the system used to apply water for evapotranspiration and leaching. The design of an irrigation system to meet the auxiliary use often requires information not presented in this section. More specific references need to be consulted.

(a) Frost protection

Agricultural and horticultural plants are often produced in regions where cold temperatures can damage crops. If the plant temperature drops below the critical temperature where damage occurs, crop production that year may be lost on perennial species, and the entire planting may die on annual species.

Crop damage can result from two types of cooling. Radiant frost occurs in a clear, calm, dry environment

where energy is radiated from the plant surface into the cold atmosphere. The ambient air temperature is generally above the critical temperature that causes plant damage, but outgoing radiation on clear nights may cool plants 1 to 4 °F below the ambient air temperature. In addition, crops withdraw energy from the air layer immediately surrounding the plants, thus air in contact with plants is generally cooler than the bulk air above the canopy. Light winds reduce the turbulence above the plants, allowing the plant surface to become colder than the air above. Frost forms on the plants when the temperature drops below the dew point of the air. This is called the critical temperature. The dew point is generally well below the critical temperature in dry environments.

An advective freeze occurs when the ambient air temperature drops below a critical value and high wind speeds increase the convective heat transfer from the cold air to the plants. Often the advective freeze is associated with the arrival of a cold front and occurs when wind speeds increase to above 10 mph. Irrigation can do little to protect plants from an advective freeze. In fact, wetting the foliage in an advective freeze can cool plants substantially, causing increased cold damage. Under windy conditions, the buildup of ice on plants and the irrigation system can cause structural damage as well. Thus, most cold protection is really for frost protection.

Some plant parts are more susceptible to damage from low temperatures than are other parts. Leaves, blossoms, and young fruit generally are the most sensitive to frost damage and are usually killed by a temperature of from 26 to 30 °F. Lethal temperatures of more hardy parts, such as buds of deciduous fruit trees, are related to stage of development. Therefore, the incentive to protect plants may be more at one time of the year than at another. Sometimes plants need to be cooled to delay bud formation early in the spring when a subsequent freeze is likely.

The processes involved in the phase changes of water must be understood to determine the irrigation required for frost protection. Water can exist as a vapor, liquid, or solid. Changing phases involves energy exchange. Evaporation requires about 1,080 BTU's of energy per pound of water at 32 °F. The reverse process is condensation, which releases energy (1,080 BTU/lb). To melt ice, energy must be added (143 BTU/lb), and to freeze water an equal amount of energy is

released. The final phase change is from a solid to vapor. Sublimation is where ice is transformed directly into water vapor without going through the liquid state. It requires about 1,220 BTU per pound.

What happens during a sprinkler application of water that provides frost protection? Consider an irrigation sprinkler operating while the air temperature is 33 °F. Water supplied to the irrigation system must be warmer than 32 °F, for example, 50 °F. After the water leaves the sprinkler nozzle, the water droplets begin to cool and evaporate. Cooling the droplets adds energy to the air. This is a primary way to use irrigation systems for freeze protection, but great care and large amounts of water are needed because only 1 BTU per pound is released for each degree Fahrenheit of temperature change of water. With time the water droplets will cool to the wet bulb temperature of the air, which is below 33 °F. If the water reaches the plant surface before dropping to the wet bulb temperature, it evaporates from the plant surface, drawing energy from the plant surface and dropping the plant temperature. If sprinkling only results in wetting the crop canopy so that evaporation occurs, the plants will be cooled below the ambient air temperature and sprinkling will actually damage the crop rather than protect it.

So what has to happen to provide protection? The processes that release energy, thereby warming plants and the air, include condensation and freezing. These processes must occur at a faster rate than the inverse processes of evaporation, melting, and sublimation. The irrigation system must be operated to provide that environment.

Coating plants with a water film can maintain the temperature above the critical plant damage point. Energy is lost from the outer surface of the water film by radiation, convection, and evaporation. The heat of fusion is released from the thin film as the water freezes. As long as the film is maintained, the temperature of the water will remain near 32 °F as freezing supplies the energy lost from the outer surface of the water film. The ice coating on the plant must be continually in contact with unfrozen water until the surrounding air warms enough so that the wet bulb temperature of the air is above the critical plant damage temperature. In California, ice-coated alfalfa plants were continually sprinkled at 0.11 inch per hour, and the plant temperature stayed above 28 °F. When the sprinkling was stopped, the sublimation of the ice

dropped the plant temperature to 12 °F, 5 °F below the 17 °F air temperature. Sprinkling generally is required until the ice formed on the plants completely melts.

Several types of irrigation methods are available to protect plants from cold damage. Successful irrigation methods include overcrop sprinkling, undertree sprinkling, fogging, and flooding (Barfield, et al. 1990). Each process is somewhat different, and each has very special requirements.

(1) Frost protection from overcrop sprinkling

Barfield listed many of the cited successes and failures of frost protection. The results have been mixed, but overcrop sprinkler frost protection has been successful for small fruit, potatoes, flowers, cranberries, and grapes. Early research in frost prevention indicated that an application rate of about 0.1 inch per hour would protect crops against radiation frosts. Subsequent work showed that plants could be protected against freezing temperatures as low as 16 °F with zero winds where the application rate is increased to 0.25 inch per hour. At this application rate, protection was obtained under winds of 12 mph, down to 30 °F air and 9 °F dew point temperatures, respectively. Only 7 to 10 percent injury to mature strawberries was observed at these temperatures. In the check plots that were not irrigated, 100 percent of the mature fruit was injured.

The appropriate application rate for frost protection depends on several factors, and general recommendations are risky as evidenced by the list of failures of overcrop sprinkling in protecting crops. Yet the results from Gerber and Harrison (1964) provide an initial estimate of the required application rate for frost protection (table 2-40). These application rates were field tested in Florida under various temperature and wind speed conditions. The most practical rates range from 0.1 to 0.3 inch per hour. Repeat frequency of leaf or foliage wetting must be at least once each minute. Sprinkling must begin by the time the wet bulb temperature reaches 4 °F above the critical temperature of the plant parts to be protected. Once in operation, sprinkling must continue until the wet bulb temperature is back above the critical temperature by about 4 °F. Systems are generally operated until the plant is free of ice because of the rising air temperature. Recommended minimum temperature for turning on or off the irrigation system for frost control of apple trees in Washington is given in table 2-41.

Design considerations for overtree sprinkling to provide successful frost protection in Washington (USDA 1985) include:

- Plastic sprinklers have been used, but metal sprinklers seem to be preferred by growers.
- Under low temperature conditions, special frost sprinklers that have hooded springs and a special arm to reduce freeze up should be used.
- For good uniformity, pressure variation along the lateral should not exceed 20 percent of the design operating pressure of the sprinklers.
- The water supply should be protected from materials that might clog the sprinkler nozzles and against sand and silt particles that may abrade the nozzle openings. Frequent checks need to be made for proper sprinkler operation and any signs of nozzle clogging or wear. Systems should be checked for proper operation before they are needed. Sprinkler failure can result in severe damage or loss of crop. The frost protection system must be able to operate on a moment's notice in case of a rapid change in weather conditions. It must also be capable of operating for hours without interruption.

- Single nozzle sprinklers generally are used to minimize the amount of water applied. Nozzles range from 1/16 to 3/16 of an inch in diameter. Operating pressures generally range from 36 to 60 psi. Uniform application is important for good frost protection, efficient application of irrigation water, and fertilizers applied through the sprinkler system. SCS practice standards for sprinkler systems require that sprinkler spacing along the lateral not exceed 50 percent of the wetted diameter.
- Good surface and subsurface drainage is necessary to protect the crop against excess water.
- Heavy fall application of plant nutrients should be avoided to prevent their loss through runoff and deep percolation.

Table 2-40 Sprinkling rate (in/hr) necessary for frost protection ^{1/}

Temperature of a dry leaf, °F ^{2/}	Wind speed, mph ^{3/}				
	0-1	2-4	5-8	10-14	18-22
27	0.1	0.1	0.1	0.1	0.2
26	0.1	0.1	0.1	0.2	0.4
24	0.1	0.2	0.3	0.4	0.8
22	0.1	0.2	0.5	0.6	—
20	0.2	0.3	0.6	0.8	—
18	0.2	0.4	0.7	—	—
15	0.3	0.5	0.9	—	—
11	0.3	0.7	—	—	—

1/ Modified from Gerber and Harrison (1964).
 2/ The temperature of a dry leaf is the expected minimum leaf temperature on an unprotected leaf. This ranges from 1 °F below air temperature on nights that have a light wind to 3 to 4 °F on very calm nights.
 3/ **Note:** These rates are based on the assumption that relative humidity does not affect frost protection. Thus the rates should be used as a first approximation in determining the application rate for design and planning. The rates should not be used to manage an actual sprinkler irrigation system.

Table 2-41 Temperatures to start and stop overtree frost protection ^{1/}

Critical temperature (°F)	Dewpoint temperature range (°F)	Minimum turn-on or turn-off air temperature (°F) ^{2/}
32	3 to 10	45
	10 to 16	43
	16 to 21	41
	21 to 24	39
	24 to 28	37
	28 to 31	35
30	31 to 32	33
	0 to 9	42
	9 to 15	41
	15 to 20	38
	20 to 24	36
	27 to 30	32
28	0 to 8	39
	8 to 14	37
	14 to 19	35
	19 to 23	33
	23 to 27	31
	27 to 28	29
26	0 to 10	35
	10 to 16	33
	16 to 20	31
	20 to 24	29
	24 to 25	27

1/ Absolute minimum temperature for turning on or off the system (2 or 3 °F higher than the indicated minimum is recommended).
 2/ Modified from the Washington State Irrigation Guide (WAIG 1985).

Experience and research have shown that overcrop sprinklers can be operated intermittently to provide frost protection while minimizing the amount of water that must be applied. The cycling frequency affects the water application rate and frost protection success. The foliage configuration of the plants, especially the amount of foliage overlap, has a significant effect. The part of the wetted area that receives water is also an important factor in selecting an application rate and cycle frequency. Perry, Martsof, and Morrow (1980) developed a model to predict the allowable "off" time for cycling based on plant needs and environmental conditions. The model is quite complex and is not generally available for design at this time. However, it could be used in specific situations to improve designs to conserve water.

(2) Frost protection from undertree sprinkling

Barfield, Perry, Martsof, and Morrow (1990) indicate that undertree sprinkling methods can also be effective in frost protection. Undertree sprinklers often produce small water droplets below the crop canopy, an area they termed "the misting zone." Here, the water droplets cool and evaporate. Thus, energy transfers from the water into the air surrounding the plants, thereby increasing the humidity of that air. If the humidification results in the formation of ice on the plants, energy is released, which can increase the degree of frost protection.

Evaporation of water from the soil surface can also enrich the humidity of the air, thus increasing the efficiency of undertree sprinkling. As the relative humidity is increased, the emissivity of the air decreases, reducing the outgoing longwave radiation and the degree of frost damage. The level of protection is dependent on the amount of water applied and the aerial extent of the freezing surface. Part of the heat from freezing and cooling of water is carried into the ground by infiltrating water. Another part goes into warming the air, and the rest into evaporation. Transfer of the heat of the frosty buds is by radiation, convection, and by condensation, which occurs on the coldest plant tissues. Ambient air temperature increases of about 2 °F are common although increases up to 4 °F have been found. Most of the systems use small (5/64 to 3/32 inch), low-trajectory (<7°) sprinkler heads at 40 to 50 psi. Application rates range from 0.08 to 0.12 inch per hour or slightly more than half of typical overtree requirements.

Although, undertree sprinkling appears to be quite promising, the physics of the process is not fully understood and the process has not been tested as extensively as overtree sprinkling. Davies, Evans, Campbell, and Kroeger (1988) developed a model to help predict the change of air temperature resulting from undertree sprinkling. Using their model, initial estimates can be made of the frost protection provided by undertree sprinkling. However, these results have been evaluated in only a few experiments. They proposed that additional testing of the procedure is needed before general design recommendations can be developed.

(3) Frost protection by fogging and flooding

Using fog generators for frost protection has had limited success. Fog can provide a radiation shield for frost protection by decreasing the amount of outgoing radiation that cools plants. To be successful, water droplets must be very small (about 10 microns in diameter). Such small drops cannot be produced with typical irrigation equipment. Fog must also be maintained in a thick layer, which is difficult to accomplish even with mild winds. The fog can also cause increased liability if the field is near a road.

Some frost protection occurs if the fog eventually freezes on plant surfaces. However, the rate of water application when fogging is generally quite low, providing less protection than sprinkling. Because sprinkled water must evaporate before condensing, fog that occurs from sprinkling offers no frost protection because of condensation. Thus, there is no net energy release. Equipment for fogging is expensive, difficult to operate, and may not be useful for irrigation. Thus, fogging appears to have limited potential for frost protection. Even if fogging is feasible for frost protection, methods to predict the required application rate and frequency for fogging are not readily available.

Flooding the soil surface can provide some frost protection for selected crops and locations. In some cases only the soil surface is wetted. The process seems to work because of increased evaporation from the soil leading to a more humid environment where condensation may be enhanced. Wetting the soil may also increase its ability to conduct heat to the soil surface, providing more short-term heating of plants. However, results have been mixed. In some cases crop damage is increased by flooding. In any case large

amounts of water may be needed, and significant lead time is required to provide enough water to flood the soil surface. The ability to flood the area limits the type of irrigation systems that are capable of providing frost protection.

Another frost protection practice is *delaying bud development*. In the fall deciduous trees enter a period of winter rest. In the spring buds begin growing, eventually leading to blossoming and leafing of the trees. Bud growth and blossom emergence are temperature dependent. Cool spring temperatures delay blossoming while warm temperatures accelerate bud development. A danger exists that premature bud and blossom development may be frozen if cold weather returns. Irrigation during warm periods early in spring may cool plant parts so that bud formation is delayed, thus avoiding later freezing of blossoms that emerge prematurely.

As with other frost protection practices, the results of evaporative cooling to delay bud formation have been mixed. Bloom delay has not been successful as a frost control measure on deciduous trees when water imbibition by the buds reduces the ability of the buds to super cool. In this case the critical temperature of the bud may be nearly the same as that of the bloom. Thus, even though bloom is delayed, little or no frost protection occurs. Sprinkled blossoms are often less winter hardy and more disease susceptible. Bloom delay has been successful for some coniferous trees, but the winter hardiness may be reduced.

Irrigation sprinkling devices must be operated to maintain the proper conditions to provide frost protection. Most experience deals with overcrop sprinkling. In the protection process, about seven times as much energy is used for evaporation as is released by freezing. Thus, for every unit of water evaporated, about seven units must be frozen to offset the energy loss. If inadequate amounts of water are applied, evaporation becomes dominant and plants rapidly approach the wet bulb temperature. The design and planning of irrigation systems for frost protection can be accomplished with existing guides; however, success requires close scrutiny and careful management of the irrigation system.

Weather forecasts provide a general alert to potential for frost, but they generally are not sufficiently site specific. Accurate temperature monitoring systems should be placed in good instrument shelters or radia-

tion screens and used at plant level. Temperature alarm systems are a good idea to warn of impending dangerous temperature levels. Visual indicators are very important in determining the suitability of the irrigation application rate and frequency. Uniform ice formation on the plants provides a simple visual indication that more water is being applied than is immediately freezing. A clear rather than milky-white appearance of the ice provides additional evidence that the plant is not being refrigerated. Barfield, Perry, Martsof, and Morrow (1990) discuss several other operational considerations for frost protection. Proper irrigation leads to plant protection with a minimum amount of water.

(b) Crop and soil cooling

Irrigation systems can also be used to cool plants, which can alleviate heat stress and delay bud development. The objective of this process is the opposite of frost protection, but same basic physics principles apply. In cooling, evaporation of water in the air and on the plant surface utilizes some energy that would otherwise be used for transpiration. In a normal environment plants can transpire adequately to maintain temperatures within a productive range. If the energy input becomes too high, the plants cannot meet the transpiration demand. The water potentials of plants decrease (i.e., become more negative) as water stress increases. If stress becomes too severe, the leaf water potentials may be reduced to growth limiting levels. The stress can normally be alleviated by adding water to increase the soil water potentials. However, on hot days heat stress may develop that limits growth even if the soil is wet and the soil water potential is near zero. Energy not used for transpiration is available to also heat the plants. Under these conditions the internal water status of plants improves only with reduction of the heat stress.

Using irrigation to cool plants and soil was reviewed by Barfield, Perry, Martsof, and Morrow (1990). Yield or quality increases, or both, have been demonstrated for almonds, apples, beans, cherries, cotton, cranberries, cucumbers, flowers, grapes, lettuce, peas, potatoes, prunes, strawberries, squash, sugarbeets, tomatoes, and walnuts. Yield increases result from improved conditions for plant growth, reduced dehydration of fruit, fewer dropped blossoms, and less "burning off" of young seedlings at or near the soil surface.

The physical processes for cooling crops for heat suppression and showing phenological development are similar and relatively well understood (Barfield, et al. 1990). The required sprinkler application rate depends on the evaporative demand of the environment. The application rate should be adequate to keep the plant surface continuously wet during the desired period. Empirical relationships have been developed to provide practical guidance for plant cooling. Sprinkler irrigation can reduce ambient air temperature from 6 to 12 °F. Hobbs (1972) determined that the potential air temperature reduction during sprinkling with a solid set system (average application rates near 0.025 in/hr) can be estimated from three climatic parameters:

$$\Delta T = -0.282 - 0.193RH + 0.114T + 0.145U \quad [2-82]$$

where:

- ΔT = Estimated air temperature reduction, °F
- RH = Prevailing relative humidity, %
- T = Prevailing ambient air temperature, °F
- U = Prevailing wind velocity, mph

Evaporative cooling from wet surfaces normally reduces leaf temperatures about 2.0 to 2.5 times the attained air temperature reduction. Crops can reach the wet bulb temperature of the air if the plant surface is uniformly and continuously wet. Soils are not cooled as extensively. The temperature near the soil surface is reduced to about half the air temperature reduction during sprinkling.

Very low application rates are adequate for cooling because of the high latent heat of evaporation of water. Application rates in reported studies have ranged from about 0.003 to 0.16 inch per hour. Maximum cooling occurs when sprinkling rates range from 1.0 to 1.5 times the prevailing potential evapotranspiration rate. Rates near the upper end of this range allow for inefficiencies caused by leaf runoff, nonuniformity of water application, and partial wetting of the leaf canopy. These rates are smaller than the typical application rate of sprinkler systems. Thus, typical systems may need modification or intermittent operation to cool the entire field adequately.

Continuous sprinkling during the heat stress period is necessary if application rates are near the potential evapotranspiration rate. Cycling sprinklers on and off every 10 to 15 minutes increases the efficiency of water use when application rates significantly exceed

the potential evapotranspiration rates. Critical temperatures for initiating plant cooling are not well established. Sprinkling is usually begun at threshold temperatures near 80 to 84 °F for cool climate crops, such as potatoes, and at 86 to 90 °F for warm season crops. Cooling of soils for germination of critical crops, such as lettuce, has shown to be effective.

(c) Wind erosion control

Wind erosion can seriously damage young seedlings and reduce the long-term productivity of soils. Erosion occurs because of the shear force of wind over the soil surface. Soil particles are picked up and carried downwind or moved across the soil surface, sometimes at a high velocity. Where the soil particles collide with young plants, severe damage can occur. Once erosion begins the process is difficult to stop. Erosion primarily occurs where the soil surface is bare or mostly bare, smooth, and is in a loosened condition because of tillage or winter freezing and thawing. This occurs mostly from fall through spring, which is the nongrowing and early growth period of summer crops. Wind speeds are typically highest in the spring; therefore, wind erosion on sandy soils can be severe during seedling development of row crops. The seedlings can be physically damaged by wind, injured by sand blasting, or both.

Irrigation can help control wind erosion by increasing:

- The cohesion of soils to form surface crusts and clods.
- Plant growth and residue following harvest of an irrigated crop.
- Cropping intensity, which shortens the nongrowing periods on cultivated, irrigated cropland.

Little research data have been published that quantifies soil-water content versus erodibility under various soil textures, temperatures, and wind speed where water is applied for the sole purpose of wind erosion control.

Irrigation of medium- to fine-textured soils consolidates loose surface soils after drying and develops surface crusts that resist erosion. The cohesive forces from wetting restrict erosion while the surface is wet. However, as the surface dries, sandy soils resume their erodibility. On highly erodible, bare soils, erosion is

very difficult to control even with a continuous-moving sprinkler system. On warm, windy days evaporation of applied water is great enough that surface soil water is lost well ahead of the time the sprinkler irrigation system rewets the soil. Tillage following irrigation while soils are moist helps produce clods that are more resistant to wind erosion.

Irrigated crops harvested for grain, such as corn, sorghum, and wheat, produce more than adequate residue to control erosion. Generally, surface residue is adequate to protect against erosion as long as the residue remains on the soil surface during the wind erosion events and while growing crop cover is inadequate to protect the soil surface. Leveling or smoothing of irrigated fields by a land plane results in a loose, erodible surface soil condition. Many times it helps to roughen the soil surface by chiseling or other tillage, or by bedding for the next crop immediately after leveling or smoothing. The bedding operation increases surface clods. Also, the bed-furrow surface configuration is more erosion resistant than a flat soil surface, but only if the orientation of the beds/furrows is perpendicular to the predominant wind direction. Irrigation systems can also be used to establish winter cover crops. The cover crops develop adequate cover in the fall to protect the soil surface until the following cash crop is planted. They are especially useful for crops that leave little residue after harvest, such as soybeans, silage corn, sugarbeets, and potatoes.

(d) Chemigation

The application of chemicals (pesticides and fertilizers) through irrigation systems is defined as chemigation. Chemigation can produce positive economic and energy savings by reducing the number of field operations using ground equipment or airplane application systems (Threadgill, et al. 1990). Good system design operation and sound management must be used.

Irrigation water requirements for chemigation generally involve the required depth of water needed to apply the chemical.

The depth of application varies tremendously depending on the type of chemical used, the location of the target pest, number of applications of each chemical during the season, and if the chemical applications are a part of the overall irrigations or are in addition.

The chemigation system consists of a chemical injection device, an injection port, a chemical reservoir, a back flow prevention device, and a calibration device. The chemical injection device should be accurate within 1 percent of maximum injection rates and should be easily calibrated and adjustable for all chemicals at the required injection rates.

Calibration of injection systems and application of the chemicals in the irrigation water is extremely important. Constant rates of chemical injection is necessary during the application process. The rate can be calculated for continuous moving sprinkler systems as

$$\text{injection rate} = \frac{\text{planned chem. app. rate} \times \text{area irrigated}}{\text{time required to irrigate the field or set}}$$

The rate and volume of water applied during the chemigation process is generally the same as the irrigation rate and volume that is applied in the same time.

Chemigation has been widely used to apply fertilizer throughout the crop growing season. Fertigation has proved to be successful on automated systems, such as trickle and center pivots. In many cases, especially on sandy soils, the efficacy of the soluble fertilizers is improved by delaying fertilizer application until the plant uptake rates increase. Often, the peak crop water use and fertilizer uptake demands coincide, and few special irrigation water requirements are necessary.

Fungicides, insecticides, and nematicides have all been applied with irrigation systems. The efficacy and economics appear to be favorable, and farmers have endorsed the practice. These chemicals are much more toxic than fertilizers and some herbicides, and great care is necessary to protect the irrigator and the environment.

Sprinkler irrigation systems are well adapted to chemigation. All types of chemicals can be applied through these systems. Center pivot and lateral-move systems are particularly well suited because of their high uniformity of water application (coefficient of uniformity, CU). The CU for water applications from properly calibrated ground-based sprayers ranges from 0.5 to 0.9 (Bode, et al. 1968). Aircraft normally obtain CU values of about 0.7 (Yates 1962). Most types of sprinkler irrigation systems can be designed and operated to achieve a CU of 0.85 or above. However,

some solid-set and periodic-move sprinkler irrigation systems as well as traveling gun type systems will achieve CUs between 0.7 and 0.8. Continuously moving lateral systems, such as the center pivot, normally achieve a CU of at least 0.85 where installed. The higher CUs of moving systems make them ideally suited to chemigation.

Principle disadvantages of chemigation include:

- Chemicals may be needed when irrigation is not required.
- The threat of ground or surface water pollution increases if accidents occur or if anti-pollution devices fail on irrigation systems supplied from pumped wells.
- Sprinkler applications during windy conditions can result in reduced uniformity, a problem that is more severe with fixed and portable systems.
- Sprinkler drift may be excessive if wind speeds exceed 10 mph. Less than 5 mph is recommended.
- Wind can cause poor weed control on the leeward side of bed or hill planted crops.
- Chemicals can be deposited in nontarget areas because of wind drift and runoff from irrigation systems.
- Wettable powder forms of herbicide are difficult to keep in suspension during injection.

Chemical application with surface irrigation systems has also been successful; however, its potential is more limited. The application of water to the relatively shallow depths required for some chemicals is difficult, and deep percolation may occur more often than for sprinkler methods. Also, poor distribution uniformity can occur with surface irrigation systems that have too long of runs or for soils that have a high infiltration rate. Uneven infiltration may lead to non-uniform chemical distribution across the field. Tailwater reuse systems are necessary to recycle surface runoff to prevent contamination of surface or ground water. Many herbicides are absorbed on the soil particles, and the water distribution process under furrow irrigation may not transport herbicides from the irrigation furrow to the top of ridge or bed where weed control is needed. The turbulence in surface irrigation water can be inadequate to keep herbicides in suspension, leading to poor chemical distribution and a lack of weed control.

Threadgill, Eisenhauer, Young, and Bar-Yosef (1990) discuss in detail the requirements for successful chemigation practices. In many areas chemigation is highly regulated. Users must comply with local, State, and Federal regulations. As always, irrigators should carefully follow label directions. Irrigation systems properly maintained and calibrated should be used under watchful scrutiny to be safe and effective.

The State Cooperative Extension Service, chemical companies, and private consultants can provide localized specific recommendations.

(e) Plant disease control

High humidity or free water on plant foliage is often necessary for infection by fungus and bacterial diseases. Irrigation, especially sprinkling, changes the environment of the air and soil surrounding crops and could increase the occurrence of such diseases. Further, irrigation leads to increased plant densities compared to rainfed production, which can intensify disease problems. Sprinkler irrigation can spread disease organisms by droplet splash from infected plants and the ensuing movement of water over the soil surface if localized runoff occurs. Runoff from surface irrigated fields can transport disease organism across one field and into downstream locations. If disease organisms enter a canal system, diseases can be transported across multiple farms.

Diseases, such as bacterial blight on beans and leaf spot on sugarbeets, may increase in severity if irrigation is applied soon after rain or if applications are prolonged. In dense growing crops, irrigation can increase diseases of vegetable fruit in contact with the soil, such as fruit rot of tomatoes, strawberries, and melons; bottom rot of lettuce; and clerotinia rot of beans. The high humidity associated with low dense crops and wet soil condition is the disease-producing environment. Damage can be reduced by using wider rows or trimming plants to increase air movement between rows.

Root rots, such as rhizoctonia and verticillium, and fusarium wilts are not appreciably affected by irrigation in the normal range of soil water management, but may be more severe under excessive irrigation and under some stress conditions. Root pruning of sugarbeets caused by large shrinkage cracks develop-

ing in swelling clays can increase rhizoctonia infection by providing entry points into roots.

Some stalk rot infections, such as charcoal rot of sorghum (which reduces grain filling, causes premature senescence, and increases lodging), are increased by plant water stress during grain filling. Normal irrigation practices during grain filling generally provide adequate control of charcoal rot. Other physiologically induced disease problems associated with plant water stress that can be adequately controlled by irrigation are internal drought spot damage to potato tubers, blossom end rot of tomato, and black heart disease of celery. Diseases associated with irrigation are likely to be more widespread on vegetables and more severe in the humid, higher rainfall areas.

Treatment for disease may be thwarted by operation of the irrigation system. Sprinkler droplets can wash fungicide residue from foliage, requiring more frequent fungicide application. Wet soils following irrigation or impending sprinkler irrigations limit the times that spray applications can be applied by ground and aerial equipment.

Notwithstanding the above discussion, research and farming experiences generally indicate that irrigation induced bacterial and fungus infections are uncommon. Irrigations usually occur during warm and mostly clear weather; while, spore germination is favored by cool, cloudy, wet weather. Apparently irrigation does not provide the favorable microclimate effect long enough for major secondary infections to develop. In fact, results have shown that well managed irrigation can reduce some stress related diseases and physiological disorders. Proper management requires knowing the right amount of water to apply and when to apply the water. Knowledge of irrigation water requirements is essential to proper management.

(f) Seed germination

Each seed species must absorb a fairly definite proportion of water before germination will start. The amount depends on the structure, size, and composition of the seed. For example, minimum seed moisture content as a percentage of dry weight required for germination is about 30 percent for corn, rice, and sugar beets; 35 percent for peanuts; and 50 percent for soybeans.

Lack of oxygen in the atmosphere surrounding the seed retards germination. Poorly drained or saturated soils are low in oxygen content. Air movement in saturated soils is much slower than that in soils at field capacity level where the free water has drained. Excessive carbon dioxide in the air surrounding the seed also may result in seed injury.

For germination, soil should have a soil-water potential of not less than 12.5 bars for corn and 6.6 bars for soybeans. The soil-water potential must remain low for 5 to 8 days to ensure adequate moisture for the seed. Wide fluctuations in soil-water potential, especially above the critical levels, severely effects seed germination. The rate of root and shoot development of newly germinated seeds, like soybeans, is greater at lower soil-water potential. Pathogen organisms also develop on seeds and roots at very low soil-water potential (around 0.3 bars), and root growth can stop when soil-water potential approaches zero or near saturation. Some crops, such as corn, are less sensitive to high soil-water content and can germinate at levels just under saturation.

Salinity also adversely effects seed germination and root development. Most seedlings are less tolerate to higher salinity levels than they are as more established plants. Problems may occur after the seed is germinated and the hypocotyls from the seed encounter high levels of salts in the surrounding soil. Hypocotyl mortality occurs with crops that are sensitive to foliar salt damage. The levels of salinity that cause foliar damage in many plants from water spray vary from as low as 5 mmho/cm up to around 40 mmho/cm for tomato plants. Seedling roots are also sensitive to excessive salinity (see table 2-34). Mortality of the emerged seedling occurs when new seedling roots are exposed to soil water that has a high salt content. Maintaining a high soil-water content decreases salt concentration, thereby reducing root damage (Stanley, et al. 1961; Mederski, et al. 1973; Rhoades, et al. 1990).

623.0207 Effective precipitation

(a) Introduction

Precipitation stored in the crop root zone can be effectively used for crop evapotranspiration and thereby meet part of the crop's irrigation requirement. Precipitation in excess of the soil-water storage capacity percolates below the crop root zone. In some locations deep percolation is necessary to remove salts from the crop root zone and to maintain salinity levels in a range required for economical crop production. In areas that do not have salinity problems, deep percolation does not reduce irrigation requirements.

The contribution of precipitation to meeting the evapotranspiration requirements may be insignificant in arid areas and a major component in humid areas. To determine the irrigation water requirements of a crop, the part of the total consumptive use furnished by precipitation must be estimated.

(b) Definition of effective precipitation

Effective precipitation as used in this section is defined as the part of rainfall that can be used to meet the evapotranspiration of growing crops. It does not include surface runoff or percolation below the crop root zone. This contrasts with the conventional hydrologic definition where effective precipitation means that part of total precipitation that contributes to runoff. Further, the definition used here does not include that part of precipitation that contributes to leaching. Leaching is important in some areas and not in others. Therefore, the contribution of precipitation to leaching is handled in computing the leaching fraction rather than included in the effective precipitation definition.

(c) Processes controlling effective precipitation

Many pathways and processes are involved in determining the effectiveness of precipitation (fig. 2-37). Some evaporation that takes place in the atmosphere is rarely measured and is not included in normal precipitation records. Precipitation that passes through the atmosphere strikes either the soil or plant surface. Precipitation intercepted by vegetation is either retained on plant surfaces where it ultimately evaporates, or it drains to the soil surface. For either case, part of the precipitation may reduce crop evapotranspiration demands and is therefore effective.

Water that strikes the soil surface, plus that draining to the soil surface from vegetation, may infiltrate, runoff, or remain in soil surface depressions and evaporate. After infiltrating into the soil surface, water can be stored in the crop root zone or percolate below it. Water retained in the crop root zone may be used for crop growth that season, or it may remain in the root zone for use during future growing seasons.

A fraction of the water that percolates below the crop root zone is useful, even essential, to remove salts in arid and semi-arid regions. The remaining component of deep percolation that is not needed for leaching can recharge underground aquifers or return to streams. However, these quantities of water do not reduce crop evapotranspiration and are not effective by the definition used here.

Some water that runs off the soil where it was received may infiltrate elsewhere in the field. If the infiltrated water remains in the root zone, it can be effectively used. Water that leaves the field is not effective.

Adequate measurements are seldom available to quantify the processes controlling precipitation effectiveness. Generally the controlling processes are so involved and the parameter data so uncertain or unavailable that simplified methods are developed and used to predict the fraction of precipitation that is effective. The processes included are rainfall, interception, infiltration, runoff, evapotranspiration, redistribution of soil moisture, and deep percolation.

Figure 2-37 Precipitation pathways (modified from Dastane 1974)

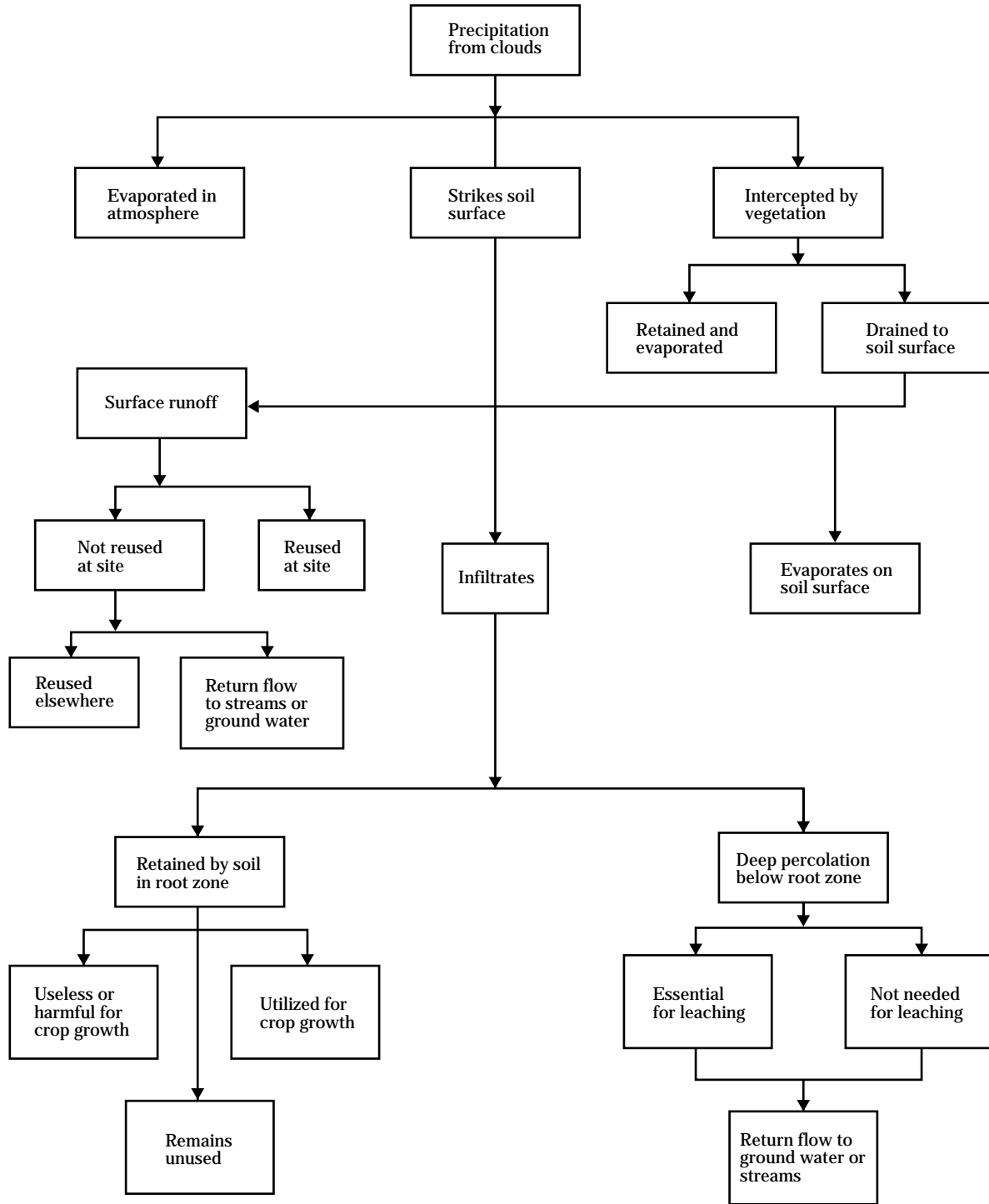

The methods used to estimate effective precipitation are based on representation and varying degrees of simplification of the hydrologic cycle. They vary depending on the level of analysis desired, such as project planning, drainage design, and such special conditions as a shallow water table and salinity management. The time step used in the measurement or calculation of effective precipitation must be carefully considered. An analysis that is sufficient for calculating the net irrigation requirements used in project planning is not the same as that needed for the real time estimation of effective precipitation required for irrigation scheduling. The estimation accuracy demanded for each need is much different.

(d) Factors affecting effective precipitation

Many factors influence the contribution of precipitation to crop evapotranspiration (table 2-42). Precipitation characteristics, soil properties, crop evapotranspiration rates, and irrigation management are the primary factors.

(1) Precipitation characteristics

The precipitation characteristics that determine the effectiveness are amount, frequency, and intensity. Each factor is extremely variable, both spatially and temporally, thus knowledge of these characteristics is essential in designing and managing irrigation systems.

Although some precipitation that evaporates from the plant or soil surface is effective in reducing crop evapotranspiration, the majority of effective precipitation must infiltrate into the soil and be stored in the crop root zone. High intensity rains, even of short duration, may exceed the soil infiltration rate and thus be less effective. Large rainfall events, even those of low intensity and long-duration may also contribute to substantial runoff and can cause deep percolation. Low-intensity, short-duration rains are generally the most effective.

The spatial distribution of precipitation also influences its effectiveness. Uniform rain over a field will raise the soil water content in a predictable way that can be included in future irrigation scheduling decisions.

Table 2-42 Factors influencing effective precipitation (modified from Dastane 1974)

Factor	Relevant characteristics
Precipitation	Depth, intensity, frequency, spatial and temporal distribution
Evapotranspiration	Temperature, radiation, relative humidity, wind speed, type of crop
Land	Topography, slope, type of land use
Soil	Depth, texture, structure, bulk density, salt and organic matter content, hydraulic characteristics
Soil water	Soil water content or potential, suspended matter, turbidity because of clay or colloids, viscosity, temperature, nature of dissolved salts
Ground water	Depth below soil surface, water quality
Management	Type of tillage, degree of leveling, type of soil management (terracing, ridging), use of soil conditioners
Channel	Size, slope, shape, roughness, backwater effect
Crops	Nature of crops, depth of root system, degree of ground cover, stage of growth, crop rotations

Nonuniform rainfall causes management tradeoffs and generally leads to reduced effectiveness. Because applying varying irrigation amounts across the field is not easy, the wetter areas of the field must receive the same irrigation amount as the drier areas. Thus, leaching occurs in the areas that received the most precipitation, and the effectiveness of the precipitation decreases.

The temporal distribution of precipitation also affects its effectiveness. Frequent rains generally lead to reduced effectiveness because the crop may not be able to use the supply as fast as the rain occurs. Infrequent rains provide time for the soil surface to dry (increasing infiltration rates) and for crops to extract soil water (reducing the chance of deep percolation).

The distribution of precipitation during the year and the regional climatic conditions greatly affect precipitation effectiveness. In arid areas where growing season precipitation is small, the moisture level in the soil profile when precipitation occurs is usually low enough so that most of the rain infiltrates and becomes available for crop evapotranspiration. Losses by surface runoff or percolation below the crop root zone are often negligible. Thus, the precipitation effectiveness in these areas is relatively high. For example, the Soil Conservation Service (SCS) estimated that the average precipitation effectiveness is 92 percent for Albuquerque, New Mexico, where the average total growing season precipitation is only 8 inches (USDA 1970).

In humid areas, rains of larger amounts and higher intensity occur more frequently during the growing season. These storms often produce water in excess of that which can be stored in the soil profile for later use. This excess water either runs off or percolates below the root zone. If the storm occurs soon after irrigation, almost all the precipitation is lost. Thus, in areas of high total growing season rainfall, the precipitation effectiveness is low as compared to that in arid areas. The SCS estimated that the average precipitation effectiveness is 64 percent at Baton Rouge, Louisiana, where the average total growing season precipitation is 39 inches (USDA 1970). In Florida, the growing season precipitation averages about 48 inches with an effectiveness of 55 percent (Jones, et al. 1984).

(2) Soil properties

Soil acts as a reservoir for the moisture supply to crops. Hence, properties of absorption, retention, release, and movement of water greatly influence the degree of precipitation effectiveness. Effective precipitation is largely determined by the soil infiltration rate and the available soil water storage. Both of these quantities depend on the soil water content. Dry soils have higher infiltration rates and larger available storage, thus they lead to more effective use of precipitation.

The infiltration rate of the soil is highly correlated to soil texture. Coarse textured soils, such as sands, generally have high infiltration rates leading to less surface runoff. Fine textured soils often have quite low infiltration rates, yielding substantial amounts of runoff.

If the water holding capacity in the crop root zone is high, the potential to store rainfall is high. This leads to effective precipitation. Conversely, if the soil water holding capacity is low, only part of some rains can be stored, which results in less effectiveness. The amount of water held and retained by a soil depends upon its depth, texture, structure, and organic matter content. Medium textured soils generally have the highest water holding capacity. The amount of soil water available to plants varies considerably. It ranges from 4 percent for coarse sands and 13 percent for clays to more than 20 percent for loamy soils. In addition, the deeper the crop root zone, the higher the precipitation effectiveness.

Antecedent soil water content also influences the amount of rainfall that can be stored in the crop root zone. Rainfall following an irrigation event reduces effectiveness. If soil water levels are maintained high by irrigation, precipitation effectiveness is lower than that for areas where more soil water depletion is allowed.

(3) Crop evapotranspiration

When the crop evapotranspiration rate is high, soil moisture is rapidly depleted. This provides more capacity for storing rainfall. If rain occurs, a large amount of water is required to reach field capacity, and losses because of runoff and deep percolation are small. Conversely, if evapotranspiration demands are small, the storage capacity for rainfall is provided at a slower rate and the capacity to receive water is less. If rain occurs, the runoff or deep percolation losses could be relatively large.

(4) Irrigation management practices

The net irrigation applied during each irrigation event is dependent upon the capacity of the crop root zone to store readily available moisture for plant use and the existing irrigation management practices.

Historically, irrigation systems were managed to refill the soil profile during each irrigation event. If a storm occurs soon after an application of irrigation water has been made, only a small percentage of the precipitation is needed to refill the profile and most of the precipitation is lost. Thus, the precipitation effectiveness may be low. If irrigation were scheduled such that small soil moisture depletions were maintained, a little soil water storage would be available to retain the rainfall. Conversely, if larger depletions were allowed, the available soil water storage would be greater, and the precipitation effectiveness would be higher.

Continuous-move irrigation systems, such as center pivots, and lateral-move systems have been operated to apply relatively small amounts of water each irrigation (generally less than 1.25 inches). If the irrigation scheduling procedures employed on the farm maintained a high soil water level or low depletions with frequent irrigations, the precipitation effectiveness would be low even for soils that have a high water holding capacity. Conversely, if the scheduling procedures maintain a relatively low soil water level or higher depletions using small, frequent, irrigations, the rainfall effectiveness is much greater. Thus, the type of irrigation system and the irrigation scheduling procedures used have a direct influence on precipitation effectiveness.

(e) Estimating effective precipitation

(1) Real-time estimates

Several irrigation management decisions require an estimate of the rainfall effectiveness on a real-time basis, often on a storm-by-storm basis. Perhaps the most common use of real-time estimates is for irrigation scheduling. When real-time estimates are needed, the amount of deep percolation and runoff must be estimated. The amount of effective precipitation for irrigation management is generally estimated using the soil water balance from equation 2-83

$$\Delta SW = P + F_g + GW - RO - D_p - ET_c - SD_L \quad [2-83]$$

or as:

$$\Delta SW = P_e + F_n + GW - ET_c$$

with:

$$P_e = P - RO_r - D_{pr}$$

and

$$F_n = F_g - RO_f - D_{pf} - SD_L$$

where:

RO_r = runoff from rainfall

RO_f = runoff from irrigation

D_{pr} = deep percolation from rainfall

D_{pf} = deep percolation from irrigation

P_e = effective precipitation

ΔSW = the change in soil moisture storage in the crop root zone

P = total rainfall during the period

F_g = gross irrigation amount during the period

GW = ground water contribution during the period

RO = surface runoff during the period

D_p = deep percolation during the period

ET_c = crop evapotranspiration during the period

SD_L = spray and drift losses from irrigation water in air and off plant canopies

All of these quantities have the same units, volume per unit area, or units of length. They occur over a given time period Δt , which can range from daily to weekly for short-term estimates.

The upper limit of the soil water content for irrigation management purposes is limited by the field capacity. Thus the maximum amount of effective precipitation for an individual storm is the amount of soil water depletion at the time of the event. If the soil water balance is maintained on a daily basis using computer predictions, then the depletion at the time of the rain can be predicted. The value for each component of the soil water balance is updated daily to maintain an estimate of the soil water content.

The amount of runoff must also be estimated to predict effective precipitation. The runoff can be predicted using the USDA-SCS curve number method applied to the specific site. The water that does not run off must infiltrate. If all the infiltration is stored in

the root zone, the infiltration rate determines the amount of effective precipitation.

For a short time after a rain, the upward flow from the ground water is very small and can be ignored in estimating effective precipitation. Likewise an irrigation is seldom applied during significant rainfall events. The evapotranspiration can be estimated for the period to complete equation 2-83. Thus the only unknown in this equation is the effective precipitation, and it can be solved for by knowing the amount of runoff and the initial and final soil water contents. This procedure is commonly done in most good irrigation scheduling programs.

(2) Monthly effective precipitation

SCS scientists analyzed 50 years of rainfall records at 22 locations throughout the United States to develop a technique to predict effective precipitation (USDA 1970). A daily soil moisture balance incorporating crop evapotranspiration, rainfall, and irrigation was used to determine the evapotranspiration effectiveness. The resulting equation for estimating effective precipitation is:

$$P_e = SF \left(0.70917 P_t^{0.82416} - 0.11556 \right) \left(10^{0.02426 ET_c} \right) \quad [2-84]$$

where:

P_e = average monthly effective monthly precipitation (in)

P_t = monthly mean precipitation (in)

ET_c = average monthly crop evapotranspiration (in)

SF = soil water storage factor

The soil water storage factor was defined by: [2-85]

$$SF = \left(0.531747 + 0.295164 D - 0.057697 D^2 + 0.003804 D^3 \right)$$

where:

D = the usable soil water storage (in)

The term D was generally calculated as 40 to 60 percent of the available soil water capacity in the crop root zone, depending on the irrigation management practices used.

The solution to equation 2-84 for D = 3 inches is given in table 2-43 and figure 2-38. For other values of D, the effective precipitation values must be multiplied by the corresponding soil water storage factor given in

the lower part of table 2-43 or equation 2-85. For example, for an average ET_c of 7.6 inches, average precipitation of 4.7 inches, and soil water storage of 2.0 inches, the monthly effective precipitation is:

$$P_e = 3.70 \text{ in (from equation 2-84)}$$

$$SF = 0.93$$

$$P_e = 3.70 \times 0.93 = 3.44 \text{ in.}$$

The average monthly effective precipitation calculated by equation 2-84 cannot exceed either the average monthly rainfall or average monthly evapotranspiration. If application of this equation results in a value of P_e that exceeds either one, the P_e must be reduced to the lesser of the two.

The procedures used to develop equations 2-84 and 2-85 did not include two factors that affect the effectiveness of rainfall. The soil infiltration rate and rainfall intensity were not considered because sufficient data were not available or they were too complex to be readily considered. If in a specific application the infiltration rate is low and rainfall intensity is high, large amounts of rainfall may be lost to surface runoff. A sloping land surface would further reduce infiltration amounts. In these cases the effective precipitation values obtained from equations 2-84 and 2-85 need to be reduced.

A recent comparison (Patwardhan, et al. 1990) of the USDA-SCS method (USDA 1970) with a daily soil moisture balance incorporating surface runoff highlighted the need for this modification. The authors concluded that the USDA-SCS method was in fairly good agreement with the daily water balance procedure for well drained soils, but overpredicted effective precipitation for poorly drained soils.

The USDA-SCS method is generally recognized as applicable to areas receiving low intensity rainfall and to soils that have a high infiltration rate (Dastane 1974). The method averages soil type, climatic conditions, and soil-water storage to estimate effective precipitation. This provides reasonable estimates of effective precipitation, especially for project planning. Further, the procedures were designed for a monthly time step. If additional detail is needed for a more thorough project analysis or for irrigation scheduling purposes, a daily time step would be required. In this case more sophisticated techniques can be used to estimate effective precipitation. Computer-based soil

moisture balance models incorporating new technology, including results from the current research thrusts in erosion prediction and infiltration modeling, can then be readily used to calculate effective precipitation.

While the current USDA-SCS method has several limitations, it is still a useful tool for the preliminary analysis of rainfall effectiveness if care is taken in its application. If daily estimates of effective precipitation are necessary, additional levels of analysis will require the use of a daily water balance with the attendant daily weather data requirements.

(3) Frequency distribution of effective precipitation

Crop evapotranspiration depends upon a number of climatic factors that vary from year to year. The variation of these factors is normally less than that in precipitation. Accordingly, the net irrigation requirement varies widely from year to year in response to changes in effective precipitation.

Because of this variation in net irrigation requirements, the development of an irrigation water supply cannot be based on average conditions. Estimates of

Table 2-43 Average monthly effective precipitation as related to mean monthly precipitation and average monthly crop evapotranspiration (USDA 1970) ^{1/}

Monthly mean precipitation P _i (in.)	Average monthly crop evapotranspiration, ET _c (in.)										
	0.0	1.0	2.0	3.0	4.0	5.0	6.0	7.0	8.0	9.0	10.0
	Average monthly effective precipitation, P _e (in.)										
0.0	0.00	0.00	0.00	0.00	0.00	0.00	0.00	0.00	0.00	0.00	0.00
0.5	0.28	0.30	0.32	0.34	0.36	0.38	0.40	0.42	0.45	0.47	0.50
1.0	0.59	0.63	0.66	0.70	0.74	0.78	0.83	0.88	0.93	0.98	1.00
1.5	0.87	0.93	0.98	1.03	1.09	1.16	1.22	1.29	1.37	1.45	1.50
2.0	1.14	1.21	1.27	1.35	1.43	1.51	1.59	1.69	1.78	1.88	1.99
2.5	1.39	1.47	1.56	1.65	1.74	1.84	1.95	2.06	2.18	2.30	2.44
3.0		1.73	1.83	1.94	2.05	2.17	2.29	2.42	2.56	2.71	2.86
3.5		1.98	2.10	2.22	2.35	2.48	2.62	2.77	2.93	3.10	3.28
4.0		2.23	2.36	2.49	2.63	2.79	2.95	3.12	3.29	3.48	3.68
4.5			2.61	2.76	2.92	3.09	3.26	3.45	3.65	3.86	4.08
5.0			2.86	3.02	3.20	3.38	3.57	3.78	4.00	4.23	4.47
5.5			3.10	3.28	3.47	3.67	3.88	4.10	4.34	4.59	4.85
6.0				3.53	3.74	3.95	4.18	4.42	4.67	4.94	5.23
6.5				3.79	4.00	4.23	4.48	4.73	5.00	5.29	5.60
7.0				4.03	4.26	4.51	4.77	5.04	5.33	5.64	5.96
7.5					4.52	4.78	5.06	5.35	5.65	5.98	6.32
8.0					4.78	5.05	5.34	5.65	5.97	6.32	6.68

^{1/} Based on 3-inch soil water storage. For other values of soil water storage, multiply by the following factors.

Water storage (D), in.	0.75	1.0	1.5	2.0	2.5	3.0	4.0	5.0	6.0	7.0
Factor (SF)	0.72	0.77	0.86	0.93	0.97	1.00	1.02	1.04	1.06	1.07

Note: Average monthly **effective** precipitation cannot exceed average monthly precipitation or average monthly evapotranspiration. When application of the above factors results in a value of effective precipitation exceeding either, this value must be reduced to a value equal the lesser of the two.

Figure 2-38 Average monthly effective precipitation as related to mean monthly rainfall and average crop evapotranspiration (based on 3-inch soil water storage)*

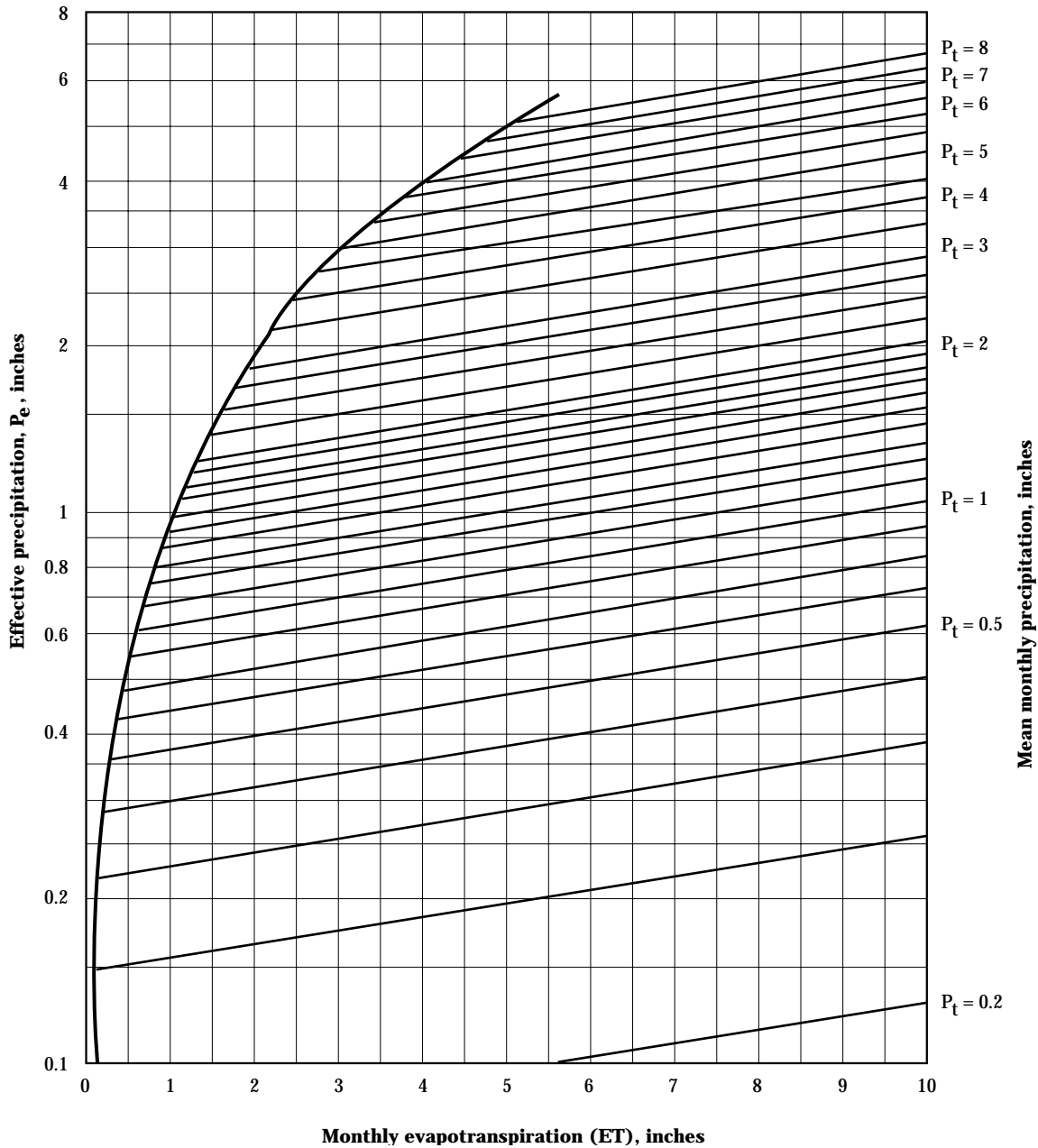

* For other values of soil water storage, multiply by the factors in table 2-43.

effective precipitation and irrigation water requirements generally are developed on a probability basis with the selection of a percentage chance of occurrence to use in design being an economic consideration. For example, providing a water supply that is adequate in 9 out of 10 years might be economical for high-value crops and only provide an adequate supply 6 out of 10 years for low-value crops.

A frequency distribution must be developed to use a probability basis to determine the appropriate depth of effective precipitation. However, the data for effective precipitation are seldom available. Therefore a method is presented to use the frequency distribution of total precipitation and the results from equations 2-84 and 2-85 to estimate effective precipitation.

To develop the frequency distribution, total precipitation records for a particular location are used to determine the total precipitation that occurred during the growing season for each year over a period of 25 years or longer. The growing-season precipitation totals are then ranked in order of magnitude and plotted on log-normal probability paper (fig. 2-39). A straight line that fits the data is then drawn. Instructions for plotting the points and drawing the frequency distribution line are in the SCS National Engineering Handbook, section 4, supplement A, part 3.18. An example of using log-normal graph paper is given in section 623.0210 of this chapter.

The frequency distribution shown in figure 2-39 provides an estimate of the probability that the total growing-season precipitation will be greater than a specified amount. For example, at Raleigh, North Carolina, there is an 80 percent chance that the total growing-season precipitation will exceed 14 inches. The average total growing-season precipitation is 17.9 inches at Raleigh (50% occurrence). The ratio of the total growing-season precipitation at 80 percent probability to the amount at the 50 percent probability ($14/17.9 = 0.78$) is used to adjust the average effective precipitation to what can be expected 80 percent of the time for the effective precipitation.

The monthly effective precipitation that would be expected for any frequency of occurrence can be estimated using figure 2-38 or table 2-43 if monthly consumptive use and monthly total precipitation for that frequency of occurrence are known. Example calculations of monthly and seasonal values of effec-

tive precipitation are shown in tables 2-44 and 2-45. The sample calculation in table 2-44 is for corn grown in North Carolina and that in table 2-45 is for alfalfa grown in Colorado.

The mean monthly ET_c and mean monthly total precipitation are determined in these tables. The average monthly effective precipitation is determined using table 2-43, figure 2-38, or equations 2-84 and 2-85. The 80 percent probable monthly precipitation for each month is determined by multiplying the average monthly precipitation by the previously determined ratio of the 80 percent probable to mean growing-season precipitation (i.e., 0.78 at Raleigh and 0.72 for Denver).

To determine the 80 percent probable effective precipitation, the mean monthly evapotranspiration and the 80 percent probable monthly total precipitation are used with equation 2-84 and 2-85 (or table 2-43 and figure 2-38).

Rainfall patterns may differ from month to month. Rather than using a constant ratio derived from seasonal or yearly data, the 80 percent probability rainfall should preferably be determined from a rainfall frequency distribution analysis prepared for each month using the method described above. This allows for a selection of rainfall probability for each month, with possibly a higher percentage when water is needed most, such as during the flowering stage of most crops. The calculations are similar to those given in tables 2-44 and 2-45 except for column 5.

Figure 2-39 Frequency distribution of growing season precipitation

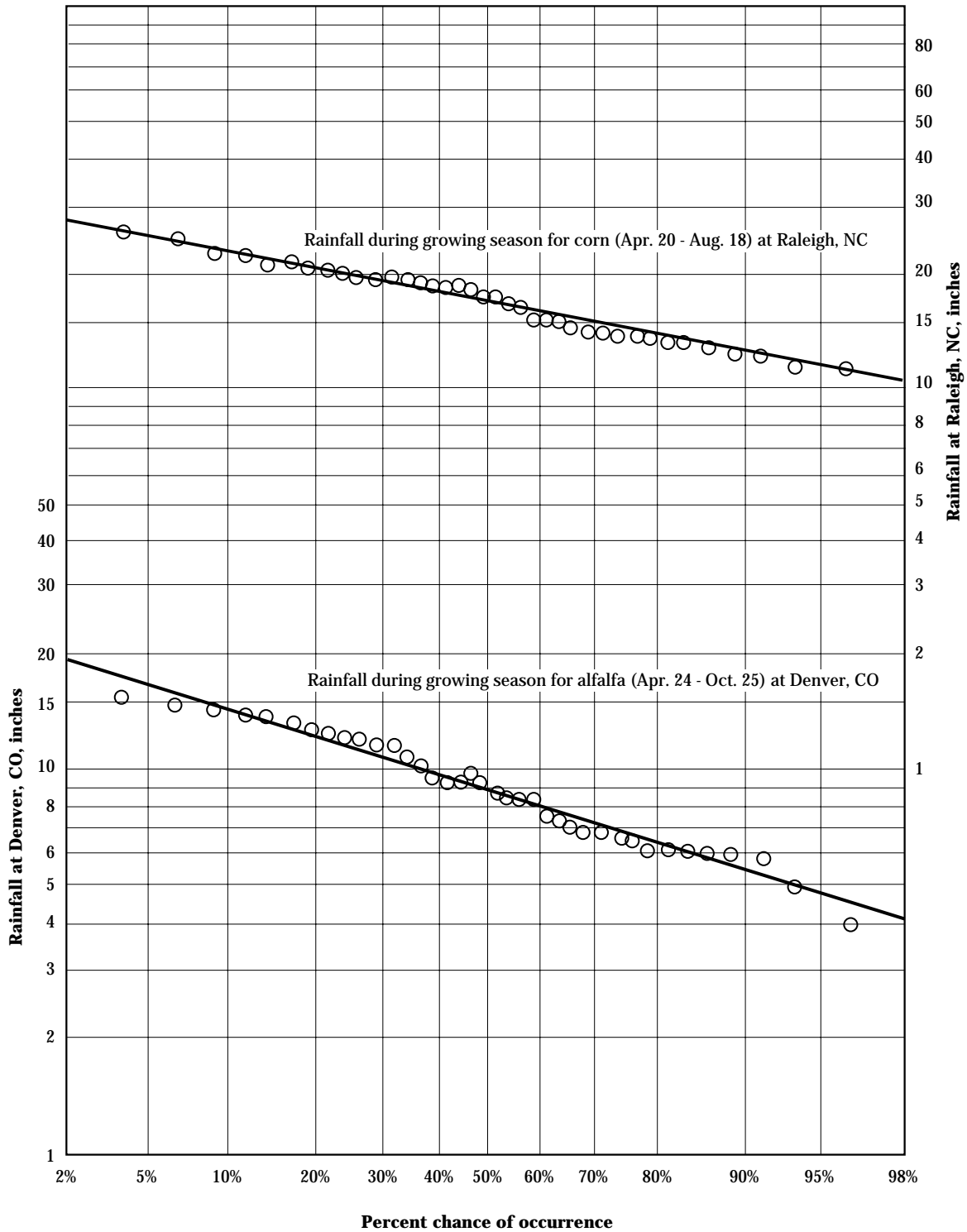

Table 2-44 Sample calculation of effective precipitation (corn at Raleigh, North Carolina)

Month	Mean monthly ET _c	Mean monthly rainfall	Average monthly effective precipitation	80% chance monthly precipitation	80% chance effective precipitation
^{1/}	(in.) ^{2/}	(in.) ^{3/}	(in.) ^{4/}	(in.) ^{5/}	(in.) ^{6/}
April (20 days)	0.70	1.20	0.66	0.94	0.54
May	3.52	3.62	2.17	2.83	1.75
June	7.84	4.05	3.04	3.17	2.46
July	8.79	5.85	4.41	4.58	3.57
August (18 days)	4.10	3.15	2.18	2.47	1.76
Season totals	24.95	17.87	12.46	13.99	10.07

1/ Duration of the growing season.

2/ Crop ET_c values shown in this column are estimated from methods described earlier.

3/ Mean monthly rainfall values are taken from Weather Bureau records.

4/ Values of monthly effective precipitation are obtained using the values shown in columns 2 and 3 together with equations 2-84 and 2-85 (using net application depths of 2 inches for corn at Raleigh, NC, and 4.2 inches for alfalfa at Denver, CO). Values in equation 2-84 are for whole months only. To obtain a value for a part of a month, the values shown in columns 2 and 3 must first be converted proportionately to whole month values and equation 2-84 then used to obtain effective precipitation for the entire month. This later value is then converted back proportionately to obtain the effective precipitation for the actual number of days involved.

5/ Values of monthly precipitation for any frequency of occurrence are obtained by first plotting a precipitation frequency distribution curve (see figure 2-39) and then obtaining from the curve the value of the growing season precipitation for the desired frequency of occurrence, in this case, 8 out of 10 years (14.0 inches at Raleigh and 6.5 inches in Denver). This latter value divided by the average growing season precipitation (17.87 inches at Raleigh and 9 inches at Denver) will give a percentage factor (0.783 and 0.722, respectively) which, when applied to the values shown in column 3, will give the values of monthly precipitation shown in column 5 on a frequency basis.

6/ The values of monthly effective precipitation shown in this column are obtained by using the values shown in columns 2 and 5 together with equations 2-84 and 2-85. See comments in 4/.

Table 2-45 Sample calculation of effective precipitation (alfalfa at Denver, Colorado)

Month	Mean monthly ET _c	Mean monthly rainfall	Average monthly effective precipitation	80% chance monthly precipitation	80% chance effective precipitation
^{1/}	(in.) ^{2/}	(in.) ^{3/}	(in.) ^{4/}	(in.) ^{5/}	(in.) ^{6/}
April (24 days)	0.57	0.49	0.33	0.35	0.24
May	3.99	2.70	1.93	1.95	1.44
June	6.36	1.44	1.24	1.04	0.91
July	7.80	1.53	1.43	1.11	1.05
August	6.66	1.28	1.13	0.92	0.82
September	4.00	1.13	0.87	0.82	0.63
October (25 days)	1.89	0.81	0.57	0.59	0.41
Season totals	31.27	9.38	7.50	6.77	5.51

See table 2-44 for footnote information.

(4) An alternative procedure

If the desired accuracy does not warrant the time required to gather the data to determine the growing season precipitation frequency distribution curve for each crop under consideration, an alternative procedure may be used. This procedure involves multiplying an average ratio to the average growing season effective precipitation to obtain the growing season effective precipitation for a given percent chance of occurrence. The average ratio varies with the desired percent chance of occurrence and with average annual precipitation as shown in table 2-45.

Again, using corn grown North Carolina as an example, it is desired to find the growing season effective precipitation that will have an 80 percent chance of occurrence. Average total annual precipitation at Raleigh is 46 inches, and the average growing season effective precipitation for corn has been determined as 12.5 inches (table 2-44). Table 2-46 gives the average ratio applicable to effective precipitation at this probability level as 0.842. Thus, the growing season effective precipitation that may be expected to occur or be exceeded in 8 out of 10 years would be 0.842×12.5 , or 10.5 inches. This compares to 10.1 inches that is calculated in table 2-44 using a monthly approach.

Example 2-23 illustrates the use of table 2-46 to estimate the effective precipitation during the growing season.

The frequency distribution of effective precipitation for months or other short-time periods may be determined by applying the same ratios shown in table 2-46.

Table 2-46 Average ratios applicable to effective precipitation

Average annual rainfall (in.)	----- Probability of occurrence -----				
	50	60	70	80	90
3	0.80	0.68	0.56	0.45	0.33
4	0.84	0.72	0.61	0.50	0.38
5	0.87	0.76	0.65	0.54	0.42
6	0.88	0.78	0.68	0.57	0.45
7	0.89	0.79	0.69	0.60	0.48
8	0.90	0.81	0.71	0.62	0.51
9	0.91	0.82	0.73	0.63	0.53
10	0.92	0.83	0.75	0.65	0.55
12	0.93	0.85	0.78	0.69	0.58
14	0.94	0.86	0.79	0.71	0.61
16	0.95	0.88	0.81	0.73	0.63
18	0.95	0.89	0.82	0.74	0.65
20	0.96	0.90	0.83	0.75	0.67
22	0.96	0.90	0.84	0.77	0.69
24	0.97	0.91	0.84	0.78	0.70
26	0.97	0.92	0.85	0.79	0.71
28	0.97	0.92	0.86	0.80	0.72
30	0.97	0.93	0.87	0.81	0.73
35	0.98	0.93	0.88	0.82	0.75
40	0.98	0.94	0.89	0.83	0.77
45	0.98	0.94	0.90	0.84	0.78
50	0.98	0.95	0.91	0.85	0.79
55	0.99	0.95	0.91	0.86	0.80
60	0.99	0.95	0.91	0.87	0.81
70	0.99	0.95	0.92	0.88	0.83
80	0.99	0.95	0.92	0.89	0.85
90	0.99	0.96	0.93	0.90	0.86

Example 2-23 Using table 2-46 to estimate the growing season effective precipitation

Determine: The growing season effective precipitation that will occur or be exceeded in 8 out of 10 years at a site where the average total annual precipitation is 30 inches and the average effective precipitation for a growing season is 12 inches.

Solution: Reading across from average annual rainfall = 30 inches, the applicable ratio is 0.81. Thus, the 80 percent probability growing season effective precipitation is $0.81 \times 12 = 9.72$ inches.

(f) Carryover soil moisture

Recharge of soil water because of rainfall during the off-season can reduce the annual irrigation requirements. However, this contribution of carryover soil moisture resulting from winter rain and snow events to the seasonal water requirements is difficult to estimate. In some areas winter precipitation is sufficient to bring the soil moisture in the crop root zone to field capacity. This is particularly true in humid areas where the custom is to deduct the readily available moisture (equivalent to the net irrigation application) when estimating seasonal net irrigation requirements. Therefore, in humid areas, the root zone can be depleted to a dry condition late in the irrigation season with the anticipation of off-season recharge. The stored soil-water contribution in this case is the mature crop root depth times the percentage depletion at the end of the growing season.

In semi-arid regions, the winter precipitation may be inadequate to completely recharge the crop root zone before the start of the irrigation season. In this case, the amount of effective precipitation during fall, winter, and spring must be predicted. This quantity represents the long-term stored soil-water contribution to the net irrigation requirements.

Where late-season water supplies are short (generally arid areas), the soil moisture is often well below field capacity and possibly down to the wilting point in the fall. Under these conditions a pre-irrigation may be

required because of the limited system capacity, inadequate rainfall, and perhaps excessive depletions from past growing seasons. Often these irrigations are the largest application of the season and can be quite wasteful. In these conditions the stored soil-water contribution to the net irrigation requirement is generally quite small.

In areas that have saline irrigation water, the stored soil-water contribution is generally small because of the leaching requirement and the necessity of maintaining a net downward water movement. Also the effects of salinity generally increase rapidly as the soil-water content drops. Therefore, the contribution of stored soil water to the irrigation requirement is generally small for areas that have salt problems.

For crops that have a 4-foot root zone, the amount of usable water that could be stored can range from 1 to 2 inches of water per foot depth of soil, or between 4 to 8 inches in the 4-foot root zone. This can be a major part of the annual requirement of some crops and can be supplied by winter precipitation in some areas in wet years. In areas where irrigation water is plentiful, it is not unusual to find the soil moisture content at the end of the season nearly as high as that at the beginning. No storage capacity is left in the root zone in these areas, and the contribution from winter precipitation is negligible. Nevertheless, the quantity of moisture carried over in the soil from winter precipitation tends to offset any deficiency in the estimated irrigation water requirements.

623.0208 Water table contribution

(a) Introduction

Methods to predict estimates of upward flow rates from a water table are presented in this section. The soil parameters required for these procedures are quite variable and may require field data for specific sites. Field monitoring should be used to ensure that values for soil properties are appropriate and that crop performance meets expectations. Upward flow from a water table can be used to meet the irrigation requirements. In the presence of a shallow water table, it can be a significant part of the irrigation requirements.

A water table near the crop root zone can supply part of the crop evapotranspiration requirements without reducing production. Generally, the rate of water supply is greatest where the distance between the bottom of the crop root zone and the water table is relatively small. However, if the water table remains too close to the soil surface for long periods of time, a lack of aeration in the root zone may develop and limit crop production. Determining the necessary drained depth has been widely researched and depends on soil, climate, and crop factors. Wesseling (1974) gives a preliminary discussion of the effect of wet soils on crop production. Drainage is beyond the scope of this chapter and is well documented in other sources, such as part 624 (section 16) of the SCS National Engineering Handbook. The purpose of section 623.0208 is to determine the amount of water provided to a crop by capillary rise from a water table.

The amount of upward flow from a water table can be important especially in areas where the required irrigation rate is small because of rain or because climatic demands are small. In areas where salinity is a problem, leaching is necessary to remove salts from the crop root zone. This water, high in salts, should not be returned to the crop root zone by upward flow.

The rate that water can be transferred from a water table to the crop depends on the characteristics of the soil, the water content of the root zone, and the depth of the water table. The movement of water through an

unsaturated section of soil depends on two soil properties—the capillary pressure head (h) and the hydraulic conductivity (K). The capillary pressure head, caused by the soil's attraction for water by capillarity, is the soil-water potential or soil moisture tension expressed as a positive value in units of length. The hydraulic conductivity is derived from Darcy's Law of waterflow in the soil:

$$q = -K(h) \frac{\partial h}{\partial z} + K(h) \quad [2-86]$$

where:

- q = volume of waterflow per unit area of soil, commonly called the soil-water flux
- $K(h)$ = hydraulic conductivity, a function of pressure head h
- h = capillary pressure head
- z = distance, expressed as depth below the soil surface

The flux has units of velocity such as inches per day.

The dependence of the hydraulic conductivity and volumetric moisture content of the soil on the capillary pressure head is illustrated in figure 2-40. The hydraulic conductivity of unsaturated soil decreases rapidly as the soil-water content decreases below saturation. Several types of functions have been proposed to describe the relationships among hydraulic conductivity, volumetric water content, and capillary pressure head. Raats and Gardner (1974) give more information on the subject. One method that has worked well for soils that have a moisture content above field capacity was developed by Brooks and Corey (1964). They described the volumetric water content by:

$$\theta_v = \theta_r + (\theta_s - \theta_r) \left(\frac{h_b}{h} \right)^{\lambda_p} \quad [2-87]$$

where:

- θ_v = volumetric water content
- θ_r = residual volumetric soil-water content defined by Brooks and Corey (1964)
- θ_s = saturated volumetric water content
- h_b = capillary pressure head at the bubbling pressure
- h = capillary pressure head
- λ_p = pore size distribution index

Figure 2-40 Hydraulic properties for sand and silt loam

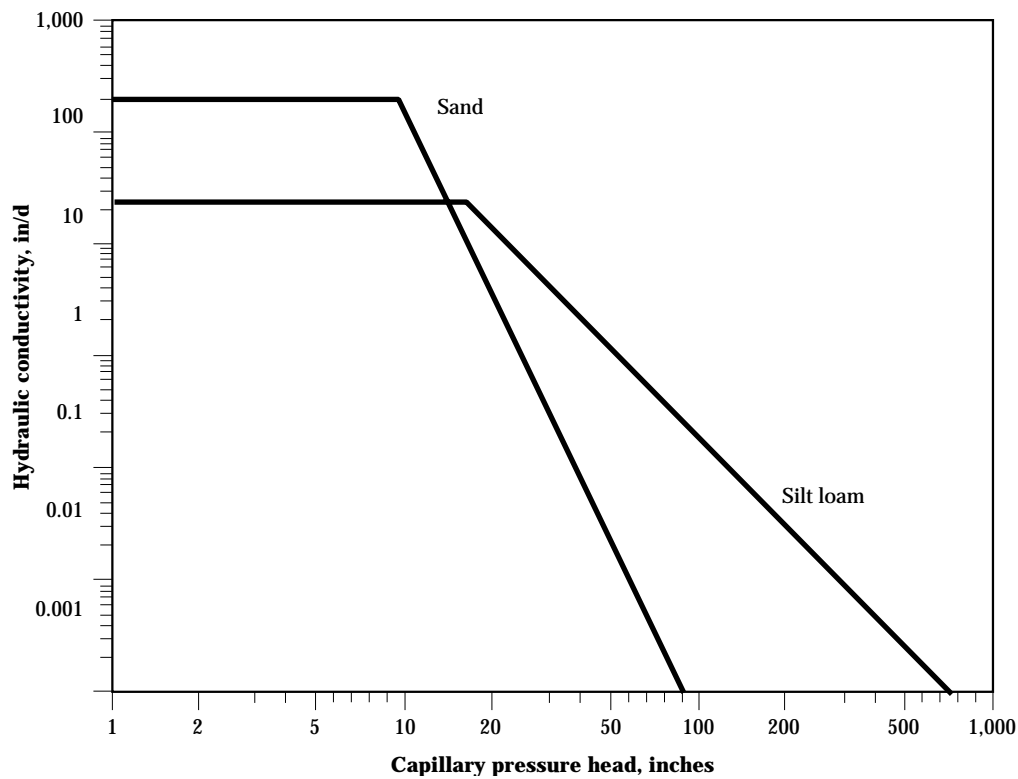
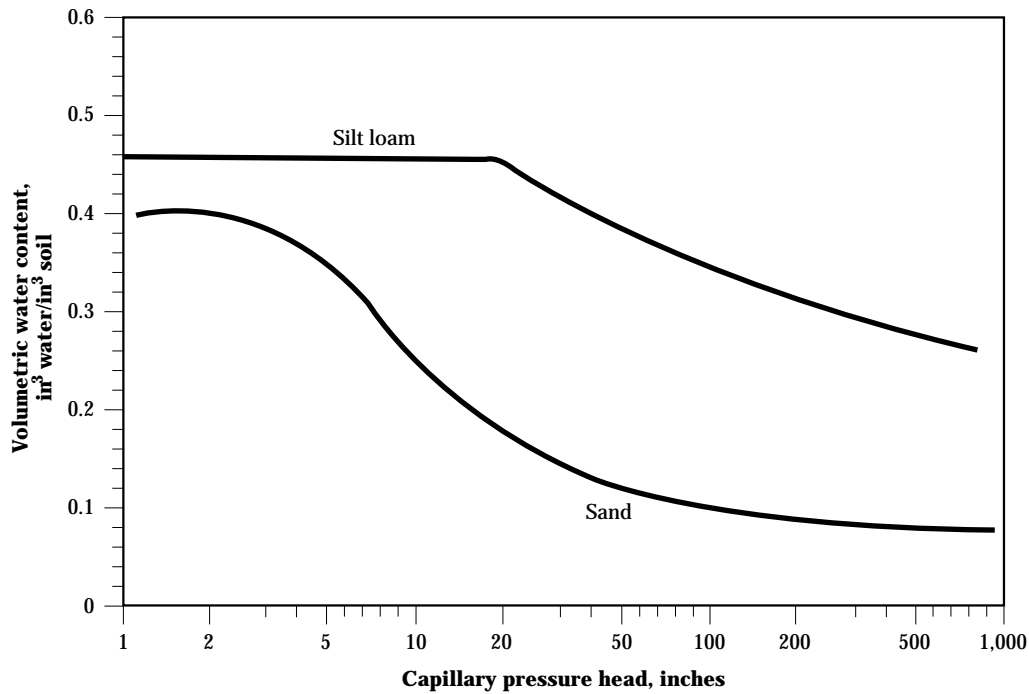

In the Brooks and Corey method, the residual soil-water content, bubbling pressure, and pore size distribution index are empirically determined for a given soil. The hydraulic conductivity is given by:

$$K = K_o \left(\frac{h_b}{h} \right)^\eta \quad [2-88]$$

where:

K = hydraulic conductivity

K_o = saturated conductivity

η = an empirical parameter equal to:

$$\eta = 2 + 3\lambda_p \quad [2-89]$$

Darcy's Law illustrates that vertical, unsaturated water-flow upward into a root zone is affected by the capillary pressure head, gravity, the hydraulic conductivity, and the depth from the root zone to the water table.

The soil properties change with soil type and the height above the water table. Figure 2-41 gives examples of the water content and capillary pressure head above a water table for two soils. At the water table, the soil is saturated (i.e., all soil pores are filled with water) and the capillary pressure head is zero. For a small distance above the water table, the soil remains saturated even though the capillary pressure head is greater than zero. The capillary pressure head where the soil becomes unsaturated is called the bubbling pressure, or the air entry pressure. Above the depth equivalent to the bubbling pressure, the soil becomes partly unsaturated (i.e., some pores are filled with air). As the depth above the water table increases, the water content of the soil decreases and the capillary pressure head increases.

The rate of decrease of water content and increase of capillary pressure head above the water table depends on the soil type. The water content of sandy soils decreases very rapidly with small changes of capillary pressure head. Thus, the water content is generally less for sands than it is for finer textured soil at equal distance above the water table (fig. 2-41).

The rate of upward waterflow depends on the unsaturated hydraulic conductivity of the soil. When the soil is saturated, the hydraulic conductivity is highest, and as the soil is dewatered, conductivity decreases (fig. 2-40). Coarse textured soils generally have a high hydraulic conductivity when saturated. The hydraulic conductivity, however, decreases very rapidly as the

water content of the soil decreases. Finer textured soils have a lower initial saturated conductivity that decreases more gradually as the soil is dewatered.

The rate of upward waterflow can either be steady (i.e., not changing with time) or unsteady (i.e., changing with time). If upward flow is assumed to be steady, the rate of upward flow can be predicted for many conditions. Transient methods are needed where the water table elevation changes quickly or where it is necessary to manage the depth of the water table. Solving for the transient rate of water contribution to the crop root zone is very complex and generally requires specialized computer programs. Unsteady solutions may be necessary for combined drainage-subirrigation systems (Skaggs 1981). The DRAINMOD program is very useful for this purpose (SCS 1983) and should be consulted if unsteady upward waterflow rates are required.

Figure 2-41 Water content and capillary pressure head for two soils that have a steady, upward flow rate of 0.1 inch per day

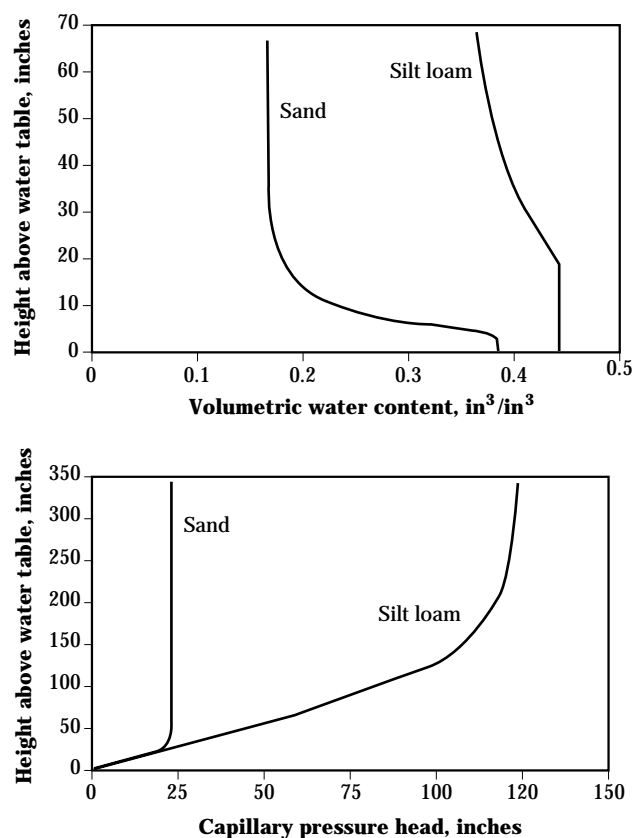

(b) Steady upward flow

Under many conditions steady, upward flow is sufficient for predicting water contributions to crop systems. Two methods to determine the approximate rate of upward waterflow are presented. The first method, a solution provided by Doorenbos and Pruitt (1977), should be considered as an approximation for representative soil types. Because individual conditions may differ dramatically, values estimated from this method should be used with caution and verified through experience. The second method is based on the analysis of Darcy's Law using the solutions by Anat, Duke, and Corey (1965). This method, referred to as Anat's Solution, requires additional soils data as will be discussed later in this section.

(1) Doorenbos and Pruitt's Approximation

Doorenbos and Pruitt (1977) presented a graphical solution for the rate of upward waterflow for several soil types and depths of the water table below the crop root zone (figure 2-42). For example, a sandy loam soil where the water table is 3 feet below the crop root zone could be expected to supply about 0.06 inch of water per day. If the water table is only 2 feet below the root zone, the upward flow is about 0.13 inch per day.

Results from Doorenbos and Pruitt illustrate that the upward flow rate is generally most significant for medium textured soils where the hydraulic gradient and conductivity together produce a usable rate of water supply. In fact, their results show that the upward flow rate is nearly insignificant for all but the medium textured soils. For example, the clay soils (No. 1 and 3) require that the water table be within 1.5 feet of the crop root zone to provide 0.05 inch of water per day. This shallow depth could pose aeration problems in clay soils. Likewise, sandy soils, such as No. 2 in figure 2-42, will not produce substantial amounts of upward flow except where the water table is very shallow. The need to consider upward flow is most important for medium textured soils. The results in figure 2-42 can be used as an initial approximation, but more refined estimates are possible using Anat's Solution technique.

(2) Anat's solution

Anat, Duke, and Corey (1965) developed an analytic solution for equation 2-86 under the conditions of steady upward flow from a water table. They used the Brooks and Corey (1964) method to describe soil hydraulic properties. The solution developed is given by:

$$d_w = h_b \left[\frac{\text{LN}(1 + q_r)}{(\eta + 1)} - \frac{q_r}{(1 + q_r)} + \frac{1 + \frac{1.886}{1 + \eta^2}}{q_r \eta} \right] \quad [2-90]$$

where:

d_w = distance from the bottom of the root zone to the water table

q_r = relative rate of upward waterflow

η = soil property defined by equation 2-89

The relative rate of upward flow is computed as:

$$q_r = \frac{q_u}{K_o} \quad [2-91]$$

where:

q_u = rate of upward flow

The Anat Solution can be summarized using relative depth to the water table and the relative rate of flow (fig. 2-43). The relative depth below the root zone (d_r) is given by:

$$d_r = \frac{d_w}{h_b} \quad [2-92]$$

To use the method in figure 2-43, the relative depth should be calculated using equation 2-92. The relative rate of contribution can be determined from figure 2-43. The daily steady state contribution can then be computed solving for q_u in equation 2-91. Example 2-24 helps illustrate the solution.

Figure 2-42 Water table contribution to irrigation requirements as a function of water table depth (adapted from Doorenbos and Pruitt 1977)

Soil type	Line number
Sticky clay	1
Loamy sand	2
Clay	3
Peat	4
Clay loam	5
Sandy loam	6
Fine sandy loam	7

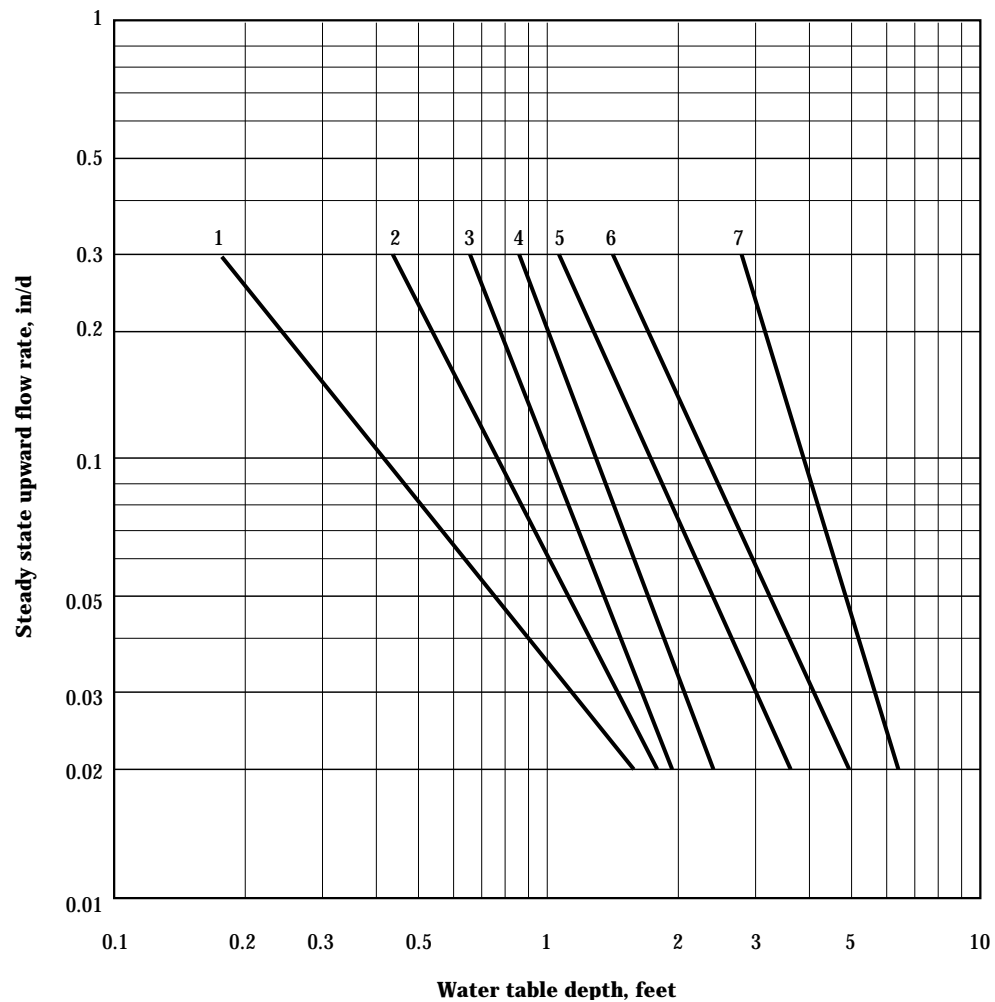
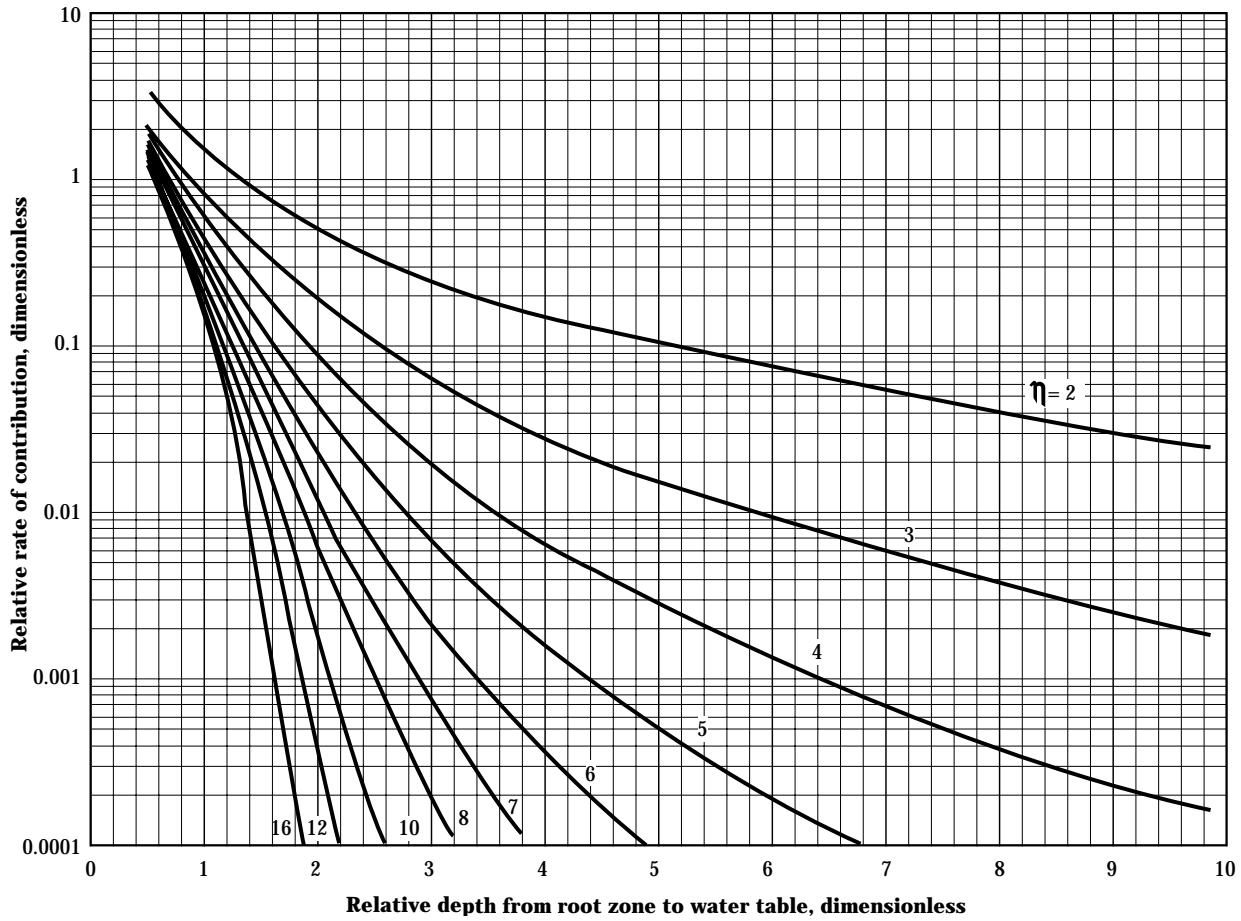

Figure 2-43 Graphical solution for the water table contribution using the Anat Solution (Anat, et al. 1965)

Example 2-24 Anat's Solution

Given: A silty clay loam soil that has a saturated hydraulic conductivity of 20 inches per day, a bubbling pressure head of 10 inches and a pore size distribution index of 1.

Required: Determine the rate of upward flow for depths to the water table of 24, 48, and 60 inches.

Solution: Compute: η using equation 2-89 $\eta = 2 + 3\lambda_p = 2 + 3(1) = 5$
 relative depth (equation 2-92) $d_r = \frac{d_w}{h_b}$

Read the value for q_r from figure 2-43.

Compute: $q_u = q_r K_o$ (equation 2-91), which has the same units as K_o .

Results:

d_w (in)	d_r	q_r	q_u (in/d)
24	2.4	0.017	0.34
48	4.8	0.00056	0.011
60	6.0	0.00018	0.004

(c) Hydraulic properties of soil

The Anat Solution (Anat, et al. 1965) depends on three soil properties (K_o , h_b , and λ_p). Research has shown that these values can vary significantly for a given soil. The hydraulic data are not readily available for most soil types and require careful tests to determine. The soil properties can be determined using procedures described by Bouwer and Jackson (1974) or Shani, Hanks, Bresler, and Oliveira (1987).

The bubbling pressure and pore size distribution index are determined from moisture release data. The moisture release curve is the relationship between the volumetric water content of the soil and the capillary pressure head (figure 2-44).

The Brooks and Corey (1964) relationship for the moisture release curve given in equation 2-87 can be rewritten as:

$$S_e = \left(\frac{\theta_v - \theta_r}{\theta_s - \theta_r} \right) = \left(\frac{h_b}{h} \right)^{\lambda_p} \quad [2-93]$$

where:

S_e = effective saturation

The effective saturation can be plotted versus the capillary pressure head as shown in figure 2-45. If the correct value of the residual soil-water content is selected, the S_e versus h data will fall on a straight line on the log-log plot. Using a trial and error procedure, the appropriate value of θ_r can be determined. Once an acceptable fit has been determined, the data can be analyzed using either a power function regression or by drawing a best fit line and determining the slope of the line. The slope of the line is equal to $(-\lambda_p)$. The slope is determined by selecting two points on the line. The two points shown in figure 2-45 were at ($S_e = 1.0$, $h = 13.5$ inches) and ($S_e = 0.34$ and $h = 200$ inches).

The value of λ_p is given by:

$$\lambda_p = - \left[\frac{\text{LN}(S_{e2}) - \text{LN}(S_{e1})}{\text{LN}(h_2) - \text{LN}(h_1)} \right] \quad [2-94]$$

where:

subscripts 1 and 2 = the points on the line

Figure 2-44 Diagram of the moisture release curve for a sandy clay loam soil using the method of Brooks and Corey (1965)

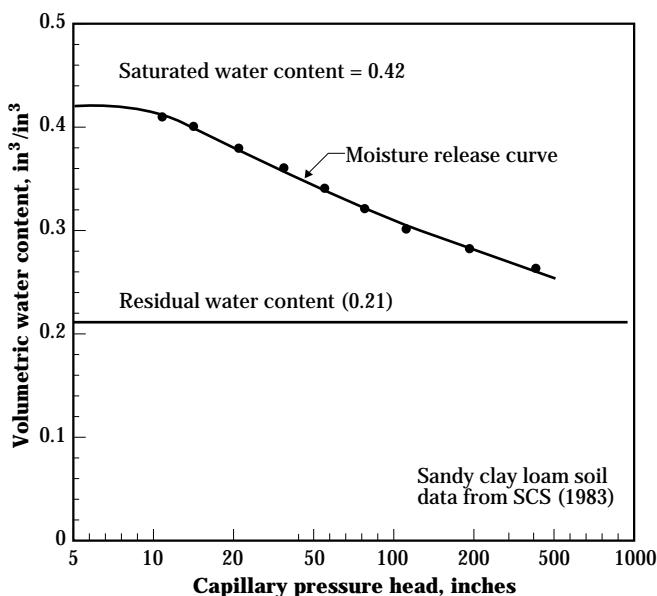
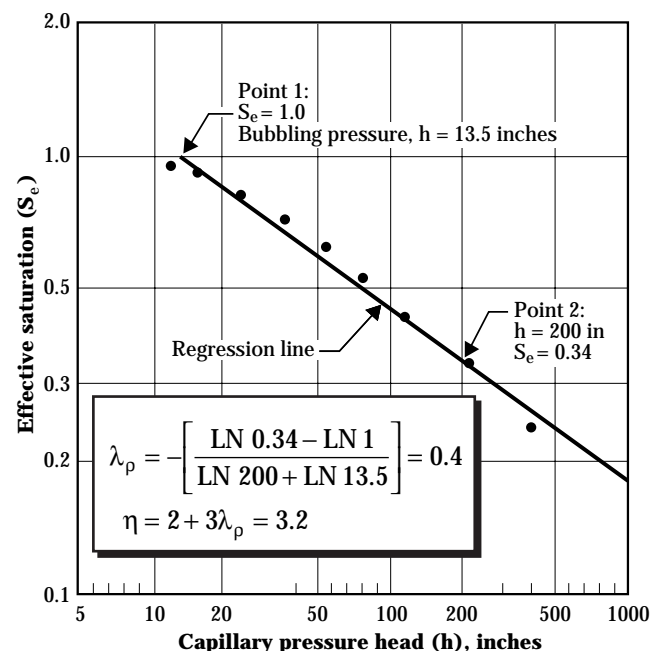

Figure 2-45 Procedure to determine the characteristic parameters for the Brooks and Corey functions



The determination of the value of λ_p for the sample data is shown in figure 2-45. The value of the η parameter is then computed using the relationship in equation 2-89.

The bubbling pressure head (h_b) can be determined when the effective saturation is equal to 1.0. From figure 2-45, the bubbling pressure head for the sample data is 13.5 inches.

The saturated hydraulic conductivity (K_o) is difficult to predict. The saturated conductivity varies for soil textures and densities, for water and soil characteristics, and for farming practices. There is widespread evidence that no-till farming substantially increases the saturated conductivity of some fine textured soils. Old root channels, wormholes, and other macropores or preferential flow channels can increase the saturated hydraulic conductivity. These large channels also provide for a very small bubbling pressure head. However, the large pores in the soil have little, if any, effect on the upward flow of water into the crop root zone. Thus, a disturbed soil sample or a sample without macropores is best used to determine the hydraulic properties for upward flow. The properties should also represent the region of the soil profile where upward flow occurs. Surface soil samples are generally not appropriate for upward flow analysis.

Experimental methods to determine the saturated conductivity have been presented by Bouwer and Jackson (1974). These methods work well for many conditions. New methods of determining hydraulic conductivity using *in situ* techniques have been reported (Shani, et al. 1987). These methods must be modified for the subsoil, but may also be very useful for field studies.

If direct measurement of the saturated conductivity is not possible, K_o can be predicted using the Brooks-Corey functions with the Childs, Collis-George integral (Brakensiek, et al. 1981). The relationship is given by:

$$K_o = 1.416 \times 10^6 \frac{\phi_e^2}{h_b^2} \frac{\lambda_p^2}{(\lambda_p + 1)(\lambda_p + 2)} \quad [2-95]$$

where:

K_o = saturated hydraulic conductivity (in/d)

ϕ_e = effective porosity

The effective porosity ϕ_e is given by:

$$\phi_e = \phi - \theta_r \quad [2-96]$$

where:

ϕ = soil porosity

θ_r = residual water content (fig. 2-44)

The porosity can be computed from the soil bulk density by:

$$\phi_e = 1 - \frac{\rho_b}{\rho_s \times \rho_w} \quad [2-97]$$

where:

ρ_b = soil bulk density (lb/ft³)

ρ_s = specific gravity of the soil solids
(typically = 2.65)

ρ_w = density of water (62.4 lb/ft³)

Using these relationships, Brakensiek, Engleman, and Rawls (1981) presented average values for the Brooks and Corey functions for various soil types (table 2-47). These values can be used as initial estimates for upward flow; however, site specific data should be obtained if possible.

Table 2-47 Average values for parameters used in the Brooks and Corey functions (adapted from Brakensiek, et al. 1981 and other sources)

Soil texture	$\phi = \theta_s$	λ_p	η	η_b (in)	K_o (in/d)
Coarse sand ^{1/}	0.40	1.2	5.6	5.0	1165
Loamy sand	0.40	1.00	5.0	3.8	750
Sandy loam ^{1/}	0.40	0.73	4.2	4.0	180
Silt loam ^{1/}	0.46	0.25	2.75	17.1	25
Loam	0.45	0.25	2.75	9.1	60
Sandy clay loam	0.41	0.34	3.0	10.2	47
Silty clay loam	0.47	0.16	2.5	14.5	10
Clay loam	0.48	0.26	2.8	10.7	36
Sandy clay	0.42	0.23	2.7	11.0	53
Silty clay	0.48	0.17	2.5	10.6	20
Clay	0.48	0.19	2.6	13.0	10

^{1/} Adjusted from data of Shani, et al. (1987).

Note: The values given in this table are typical values that depend on soil structure and other factors as well as texture. These values should be treated as estimates to be used only when better data cannot be obtained.

623.0209 Irrigation efficiencies

(a) Introduction

Irrigation efficiency is an index used to quantify the beneficial use of water diverted for irrigation purposes to a community, farm, field, or system. Overall irrigation efficiency (E_i) includes:

- Irrigation water management decisions, including timing and amount of application (irrigation scheduling)
- All losses in providing the planned irrigation water to the area irrigated

Water management decisions strongly influence E_i for surface systems, while physical site conditions and irrigation facilities control to a greater extent how uniform water can be applied in sprinkler, micro, and subsurface systems. Application uniformity is commonly measured as the irrigation system distribution uniformity (DU). How efficient channels and pipelines transport water is termed conveyance efficiency (E_c).

Micro, sprinkle, surface, and subsurface are irrigation methods. One or more irrigation system types can be used to apply water by a chosen method. For example, graded furrow, graded border, level furrow, and basin systems apply water using the surface irrigation method. The most appropriate method and system for an area depend upon physical site conditions, the crops being grown, timing and amount of water available, and management skill available. Any irrigation system can have overall irrigation efficiencies in the low to mid 90's. However, the proper irrigation method to fit the water, crop and site conditions, and a high level of management are required to accomplish such a high efficiency.

(b) Irrigation efficiency (E_i)

Irrigation efficiency is the ratio of the average depth of irrigation water beneficially used to the average depth applied, expressed as a percentage.

Irrigation efficiency represents the percentage of applied water that is potentially accessible to crop evapotranspiration, crop heating (frost control), crop

cooling, crop quality control, and leaching of salts from the soil profile. The irrigation efficiency is affected by the uniformity of distribution and losses. If either the uniformity of distribution decreases or losses increase, the overall irrigation efficiency generally decreases. Irrigation efficiency is directly related to the percentage of irrigated area being under irrigated or over irrigated. Therefore, irrigation system designs that maximize uniform application as well as minimize water losses caused by improper management (often poor irrigation scheduling), evaporation, wind drift, runoff, or deep percolation produce the greatest irrigation efficiencies.

Irrigation efficiency is a function of: the irrigation method used, physical condition of the irrigation system, physical condition of the soil, plant or crop type, spacing and population, timing and amount of irrigation water applied, water management level and skill, and environmental condition at the time water is applied. The way in which these functions interact with respect to uniformity and losses determines the irrigation efficiency.

(1) Water losses during application

Water loss varies with the type of irrigation method and system, the environmental conditions under which the system is operated, and the type and condition of conveyance system. For a well designed and installed irrigation system that fits the crop, water, and site conditions, water management is the principal means available by the irrigator to ensure that losses are held to a minimum. In the absence of reliable irrigation scheduling practices, the general tendency is to over water, resulting in excess runoff and deep percolation below the root zone. However, if the dryness appearance of plants is used as an indicator for scheduling, the tendency is to under irrigate. During hot, dry days a plant whose root development depth was restricted by over irrigation early in the growing season, can show stress even though adequate moisture exists in the normal root zone. This condition usually results in over irrigation.

(2) Sprinkle irrigation method

For sprinkle irrigation, major sources of water loss include:

- Improper water management (applying water when it is not needed or in excessive amounts)
- Evaporation from droplets, the wetted canopy, and the soil surface

- Wind drift
- Runoff and deep percolation
- Leakage from conveyance system, worn nozzles, gaskets, or other equipment

Direct evaporation from droplets during irrigation is typically small except under very high evaporative conditions. Such losses are normally less than 5 percent of the total water that is applied, but increases as droplet size decreases and vapor pressure deficit increases. Losses as high as 45 percent have been measured under very low relative humidity and high temperature and wind conditions. Likewise, the longer droplets are airborne, the greater will be the water loss. Therefore, designs are preferred that minimize the height of sprinklers above the soil or canopy while still maintaining adequate uniformity and appropriate application rates.

For a given set of environmental conditions, evaporation from the wetted canopy is dependent on the type of crop, stage of growth, total leaf area, wind speed, wind direction, ambient air temperature, humidity, and duration of irrigation. Evaporation from the leaf surface of a crop canopy that covers the entire soil surface is the principal source of evaporative loss during irrigation. It amounts to as much as 25 percent of the total water loss for the day (Thompson, et al. 1988). Depending on the environmental conditions, the canopy may remain wet for 30 minutes or more after irrigation has ended. Therefore, the longer the irrigation set, the smaller the percentage of loss will be. Low Pressure In Canopy (LPIC) continuous-move laterals apply water a few inches above the soil surface low within the crop canopy, thereby eliminating the evaporation losses from the canopy. Where continuous-move LPIC sprinkler laterals apply water to less than half of the surface area and are used with appropriate soil, plant, and water management that controls water translocation, the system can be a Low Energy Precision Application (LEPA) system.

Evaporation from the soil surface varies with wind speed, temperature, and canopy development. A canopy that provides full shading for the soil surface reduces soil evaporation losses. Likewise, wind increases turbulence at the soil surface, increasing soil evaporation. The total water loss attributed to soil evaporation is typically less than evaporation from the leaf surfaces, but may become relatively significant immediately after sprinkle irrigation. Where soil loss is

high, evaporation from canopy is generally low (low canopy cover). Where canopy loss is high, typically soil loss is low (shading affect from high canopy cover).

Wind drift is primarily considered a uniformity problem although it can also contribute significantly to water losses if water droplets are small or if the drift is carried outside the field. Losses are typically less than 5 percent of the applied water, but vary depending on system type, operating pressure, and orientation to the wind. Drift losses are greater where the wind direction is parallel to the lateral or line of sprinklers and the wind blows toward the outer edge of the field. In comparison, drift losses are minimized for center pivots because the angle between the wind and lateral is continually changing.

Drift is a function of droplet size, droplet shape, and wind speed. It increases rapidly for droplets that are smaller than 0.04 inch. Because wind speed increases with height above the soil surface or canopy, the greater the trajectory angle or height of the nozzle, the more drift affects uniformity of application and the potential for loss. Therefore, designs are preferred that use low sprinkler trajectories or that place the nozzle closer to the crop canopy or in the crop canopy.

Properly designed and managed sprinkle irrigation systems should not produce runoff or deep percolation. Therefore, the key to minimizing such losses is proper management. For solid-set systems, differences in application uniformity because of wind drift may result in some areas of the field receiving more than the design depth of application and other areas receiving less. Fields irrigated by center pivots are subject to runoff near the outer edge where application rates are greatest. As surface roughness and residue decrease during the growing season because of tillage, rainfall, and irrigation, soil infiltration and surface storage capacity decrease. Application rates that are acceptable early in the season can result in runoff later. In addition as water droplets impact the soil surface, infiltration rates may decrease because of surface seal formation.

For well maintained sprinkle irrigation systems, pipe leakage and drainage losses should be held to 1 percent or less. Sprinkler drainage losses can be eliminated by incorporating antidrain valves at each sprinkler. As with all irrigation systems, proper water

management and a routine maintenance program should be established and adhered to for preventing water loss and ensuring proper operation of the system.

(3) Micro irrigation method

For micro irrigation, major sources of water loss include:

- Improper water management (applying water where it is not needed or in excessive amounts)
- Evaporation from the wetted soil surface
- Runoff and deep percolation
- Leakage from conveyance system

Water is normally not discharged into the atmosphere above the crop; therefore, micro systems are not subject to drift nor to droplet and canopy evaporation except with micro sprinklers and spray nozzles. Because application rates are typically quite low, the potential for runoff is reduced compared to sprinkle irrigation. Water infiltration rates are also more constant during the growing season since surface sealing caused by puddling from droplet impact is reduced.

(4) Surface irrigation method

Major sources of water loss for surface irrigation include:

- Improper water management (applying water where it is not needed or in excessive amounts)
- Evaporation from the wetted soil and water surfaces
- Runoff and deep percolation
- Leakage from conveyance system

Surface systems are not subject to wind drift losses nor evaporation from the wetted canopy. However, runoff and deep percolation generally are greater for graded surface systems than for well managed sprinkle irrigation systems. Typically, the combined losses of deep percolation and runoff dominate to the point that evaporation loss from the soil surface is relatively minor in comparison. However, with the appropriate match of soils, crops, field gradients, and water volume, a properly designed, installed, and managed surface system can have a higher efficiency than that for sprinkle irrigation.

Because the soil is used to transport water across the field, the infiltration opportunity time varies as water is moved from the inflow end to the outflow end of the field or is stored on the soil surface generally in lower areas. Therefore, designing and managing a graded

surface irrigation system for a wide variety of crops and adequately irrigating all parts of the field without over-watering another part is more difficult unless a tail water reuse system is included. With a very low gradient system, runoff can be minimized or eliminated by blocking off the end of the field or furrow, by decreasing grade or having level sections at the lower end, or by reusing the runoff water on the same or adjacent fields. Improper decreasing of tail water runoff without a reuse system can result in increased deep percolation losses and a lower distribution uniformity. Level basin, level furrow, and contour levee surface irrigation systems are relatively easy to design, install, and manage if soils are uniform and large volumes of water can be diverted or pumped onto the irrigated area.

(5) Subsurface irrigation method (subirrigation and water table control)

For subsurface irrigation systems, major sources of water loss include:

- Improper water management (primarily irrigation scheduling resulting from poor timing of water introduction, the water table being kept too high or too low)
- Evaporation from soil and water surfaces
- Deep percolation and lateral seepage

Subirrigation systems are not subject to wind drift or evaporation from wetted plant surfaces. Deep percolation losses can become significant depending on the permeability of the restricting barrier that supports the water table. Lateral seepage losses can vary greatly depending on the depth of water table in adjacent land, location of deep channels, and permeability and depth of soil strata.

Because the water table should be maintained at a nearly constant elevation, provisions should be made for irrigation water inflow or drainage and rainfall outflow. Water management involves maintaining a nearly constant water table elevation within desirable levels during periods of rainfall, no rainfall, and crop water use. Unless excess chemicals are applied to plant and soil surfaces where they can be subjected to runoff, good ground water quality can be maintained with a subsurface irrigation system. Percolating water containing soluble chemicals tend to concentrate the chemicals in the upper few inches of a free water table. As plants use water, the water table drops, leaving chemicals behind for plant use.

(c) Uniformity of application

(1) Distribution Uniformity (DU)

Distribution uniformity is the measure of the uniformity of irrigation water distribution over a field. SCS typically uses DU of low one-quarter. **DU is the ratio of the average of the lowest one-fourth of measurements of irrigation water infiltrated to the average depth of irrigation water infiltrated, expressed as a percentage.**

In comparing irrigation systems, micro irrigation, level basin irrigation with uniform soils and adequate flow volume, and continuous move laterals have the greatest capability of maintaining the highest uniformity of application. Graded surface irrigation systems on nonuniform soils generally have the lowest. Depending upon the physical conditions at the site and the level of management, the reverse may also be true.

In micro irrigation, the point of water discharge is the desired point of infiltration. The volume of water available for discharge at a point downstream is independent of the depth of water infiltrated upstream. As long as the tubing is sized adequately to accommodate the system flow rate within pressure loss allowances, the discharge potential at each emission device will be similar. In addition, the time that water is available for discharge is nearly equal at all emission points along the lateral if the lateral is reasonably level.

In surface irrigation systems, flow rate downstream decreases as infiltration occurs upstream. Because water movement along the furrow or border is directly related to this available stream size, both the infiltration opportunity time and the volume of water for a given surface area decrease somewhat from the inflow to the outflow end of the field. For sprinkle irrigation systems, actual uniformity varies depending on whether the system is fixed (solid set), periodic move, or continuously moving, and the associated sprinkler nozzle discharge pattern. In the absence of wind and extreme high temperatures, properly designed, operated, maintained, and managed sprinkle systems typically have uniformity's between those of micro and graded surface systems.

The physical condition of the irrigation system may also affect the uniformity of water application. Surface systems have minimal water distribution hardware and are least affected by age or physical condition as long

as soil surface smoothness is maintained. Instead, inflow rate and soil conditions, including grade uniformity, control water distribution across the field. However, this is not the case for micro or sprinkle systems. For micro irrigation, the emitter is the major cause of nonuniform water application. Because of manufacturing variations and plugging, emitters of the same size and design differ slightly from the stated discharge-pressure relationship. By using multiple emitters in the same emission area, discharge variations are minimized and reliability of applying the designed amount of water is increased. Because of their small orifices, emission devices are subject to clogging. Therefore, proper filtering of water, periodic filter back-flushing, and use of chemical treatment are required to maintain high distribution uniformity.

Sprinklers are subject to nonuniform water application because of the differences in rotation speed, changes in orifice diameter caused by wear, irregularity of trajectory angle caused by nonvertical risers, and wind effects on aerial water distribution. Wind distortion can be partly overcome by spacing sprinklers or tow paths more closely together, using sprinklers that have a lower trajectory angle, and placing sprinklers or spray nozzles closer to or within the crop canopy. If improperly designed and managed, sprinkler or spray nozzles can result in a low distribution uniformity because of crop interference. For continuously moving sprinkler systems, tower start-stop times affect uniformity, especially with sprinklers having small wetted diameters. However, such nonuniformities tend to even out over a growing season because such movements in the field are random.

Another source of nonuniformity for sprinkle and micro irrigation systems is changes in elevation along the lateral. Because micro systems normally operate at pressures much less than those for sprinkler systems, a given change in elevation has a larger relative effect on water pressure and discharge. Pressure regulators, line flow control devices, and flow control nozzles are available for both systems to reduce these variations. Pressure compensating emission devices for micro laterals can also reduce this sensitivity.

To compare the uniformity of water application between different irrigation methods and systems, methods can be developed for assigning numerical values to actual field test data. Such methods include distribution uniformity (DU) for the average low-quarter or

low-half depth and Christiansen coefficient of uniformity (CU).

For each irrigation method, DU can be used to indicate the uniformity of water application throughout the field. It is computed as: [2-98]

$$DU = 100 \left(\frac{\text{Avg. low - quarter depth of water infiltrated}^*}{\text{Avg. depth of water infiltrated}^*} \right)$$

* For sprinkle and micro systems, use catch can measurements; for surface systems use infiltrated depth.

The average low-quarter depth of water infiltrated is the average depth of the lowest one-quarter of all measured values, each of which represent an equal area of the field. A similar definition is used for the high quarter depth and low half depth.

(2) Christiansen's coefficient of uniformity (CU)

CU is also used to evaluate application uniformity. When all areas represented by each observation are equal, CU is determined as:

$$CU = 100 \left(1 - \sum_{i=1}^n \frac{|\bar{x} - x_i|}{n\bar{x}} \right) \quad [2-99]$$

where:

- x_i = the depth of observation i
- \bar{x} = mean depth for all observations
- n = number of observations

When CU is greater than 70 percent, test data typically form a bell shaped curve that is normally distributed and symmetric about the mean. For such cases, CU can be approximated as: [2-100]

$$CU = 100 \left(\frac{\text{Avg. low - half depth of water infiltrated}^*}{\bar{x}} \right)$$

* For sprinkle and micro systems, use catch can measurements.

Using this definition, an approximate relationship between DU and CU can be written as:

$$CU = 100 - 0.63(100 - DU) \quad [2-101]$$

Similarly, this can be solved for DU as:

$$DU = 100 - 1.59(100 - CU) \quad [2-102]$$

(d) Application efficiency (E_a)

Application efficiency is the ratio of the average depth of irrigation water infiltrated and stored in the root zone to the average depth of irrigation water applied, expressed as a percentage.

Application Efficiency Low Quarter (AELQ) is the ratio of the average of the lowest one-fourth of measurements of irrigation water infiltrated to the average depth of irrigation water infiltrated, expressed as a percentage. This term is most often used in defining management effectiveness.

The greatest irrigation water loss generally results from applying too much water too soon (improper irrigation scheduling). Deficit irrigation of a significant part, or all, of the irrigated area is an exception. Other water losses include evaporation from soil and leaf surfaces, runoff, percolation below the plant root zone, and wind drift. In all cases irrigation water management has a large influence on the net amount of water available for beneficial use. **Application efficiency is primarily affected by operator irrigation water management decisions.** An adequately designed and installed system can be badly mismanaged.

Evaporation losses vary with the irrigation method, system used, and system operation. It can occur directly from the wetted soil or water surface, wetted plant canopy, and droplets discharged from sprinkler nozzles. Evaporation from the soil surface relative to other losses decreases as the depth of application increases. Surface, subsurface, and micro systems (except micro sprinklers and sprays) are subject only to evaporation at the soil surface since the canopy is not wetted during irrigation. As the crop canopy develops and the soil is shaded, soil evaporation losses are further reduced. Evaporation from sprinkle irrigation tends to be greater than that from surface and micro systems because of the increased surface area wetted as well as that water may be discharged directly into the atmosphere above the crop canopy. As wind speed and vapor pressure deficit increase and droplet size decreases, droplet evaporation increases.

Runoff is a function of soil surface slope and storage, the infiltration rate of the soil, and the application rate of the irrigation system. Properly designed micro and

sprinkler systems should have no runoff if correctly designed, installed, and managed. Water management is important with all irrigation systems. This is especially true for sprinkler systems because the impact of droplets on the soil surface can reduce surface storage and can produce a surface seal that reduces infiltration during subsequent irrigations.

To be adequately and fully irrigated, all graded surface irrigation systems must have some runoff unless the end of the field is severely underwatered, level field sections are provided at the outflow end, or the ends are blocked on low gradient fields. With nearly level surface irrigation systems, small dikes across the end can be used to increase irrigation uniformity. Blocked ends are most effective when opportunity time is increased on the lower third to fourth of the field. Runoff loss from the field can also be reduced if tail water is collected for reuse on the same or adjacent fields.

Deep percolation occurs where the infiltrated volume of water exceeds the volume needed to bring the soil-water content in the plant root zone to field capacity. Properly designed and managed irrigation systems that are installed on suitable sites can have very little or no water lost to deep percolation. Unless the upper fourth of the field is chosen for the design application depth, some deep percolation always occurs where graded

surface irrigation is used. This is necessary to ensure sufficient stream size and infiltration opportunity time at the outflow end of the field for filling the root zone to field capacity or to some planned lesser level.

Cutback, tail water reuse, surge, or cablegation techniques can be used to minimize deep percolation losses. Often irrigation stream size is decreased to reduce or eliminate tail water runoff at the expense of increasing deep percolation and irrigation nonuniformity. Runoff and deep percolation should be managed because they largely affect efficiency and are the primary transport mechanisms for off-site surface and ground water pollution.

The term most often used to define management effectiveness is application efficiency (E_a). However, because application efficiency is a function of water losses, a high value does not necessarily mean an effective and uniform irrigation. For example, runoff and deep percolation can be eliminated by severely underwatering, but an E_a near 100 percent can result. (E_a cannot exceed 100 percent.) If insufficient water is stored in the root zone in most of the irrigated area to meet the crop water requirements, crop performance (yield or biomass) will be reduced. Therefore, a more complete definition of an effective irrigation should include the concepts of adequacy and uniformity of application. (See equations below.)

$$E_a = 100 \left(\frac{\text{Average depth of irrigation water stored in the root}}{\text{Average depth of irrigation water applied}} \right)$$

$$\text{AELQ} = 100 \left(\frac{\text{Avg. depth of irrig. water stored in the low quarter root zone}}{\text{Avg. depth of irrigation water applied}} \right)$$

(e) Irrigation adequacy

(1) Adequacy of irrigation

Adequacy of irrigation is the percentage of the field that receives the desired amount of water. In arid and semi-arid regions where the probability of sufficient rainfall is low, each irrigation typically fills the soil profile to field capacity or to some planned lesser level. In sub-humid and humid regions, this may be less than field capacity to provide storage for rainfall that may occur between irrigations. The choice of how much water to apply may also be a function of the sensitivity of the crop to water stress, its market value, and water supply.

Adequacy of irrigation can most easily be evaluated by plotting a depth of application distribution as shown in figure 2-46. The curve is developed by grouping field measurements of application depth in descending order, accounting for the field area that each measurement represents. The point where the curve intersects the line for desired application depth indicates the percentage of the field that is being adequately irrigated. Note that the distribution gives the amount of water applied (received by each part of the field and can be used to calculate DU, the area under irrigated, and the area over irrigated). Deep percolation moves chemicals below the root zone and can contribute to ground water pollution. Both under and over irrigation can result in crop yield and quality reduction.

Figure 2-46 Distribution of field application depth indicating adequacy of irrigation

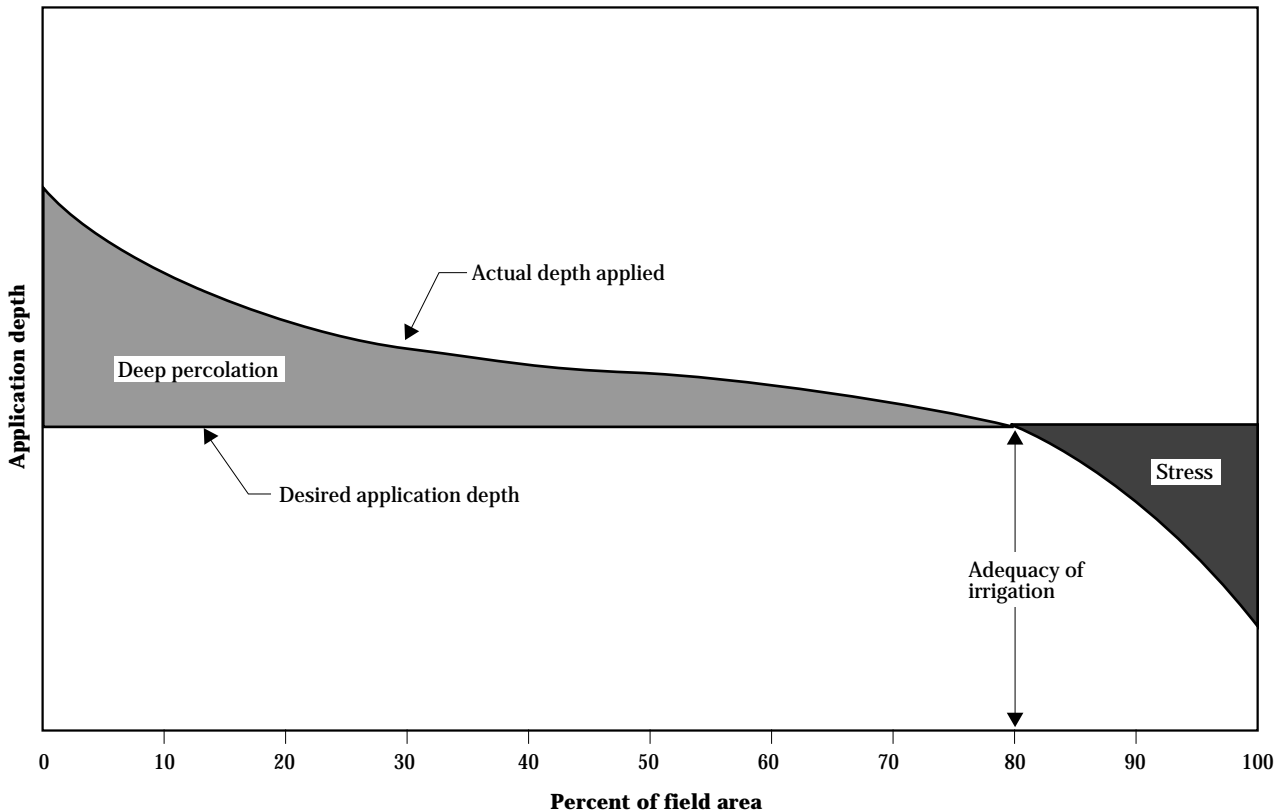

The relationship DU and E_a is demonstrated in figure 2-47. Here, two irrigation systems (A and B) having the same adequacy, but different uniformity's and E_a are shown for the same field. The application depth for each system is equal to the area under the curve for full irrigation (i.e., field capacity). Therefore, if uniformity of application (DU or CU) was 100 percent, both curves would fall exactly along the line for full irrigation. Note that since curve A is flatter, it has the better uniformity. The amount of over and under irrigation

for system A is represented by the area a_1 and a_2 , respectively, and for system B as a_1+b_1 and a_2+b_2 , respectively. Because over irrigation (potential for runoff and deep percolation) is greater for system B, that system has a lower E_a than system A. Therefore, for irrigation systems designed to apply water to field capacity, improving application uniformity also improves the E_a . However, this is not true for systems that under or over water the entire field because the total amount of water loss remains unchanged.

Figure 2-47 Distribution for two irrigation systems having equal adequacy but different uniformity and application efficiency

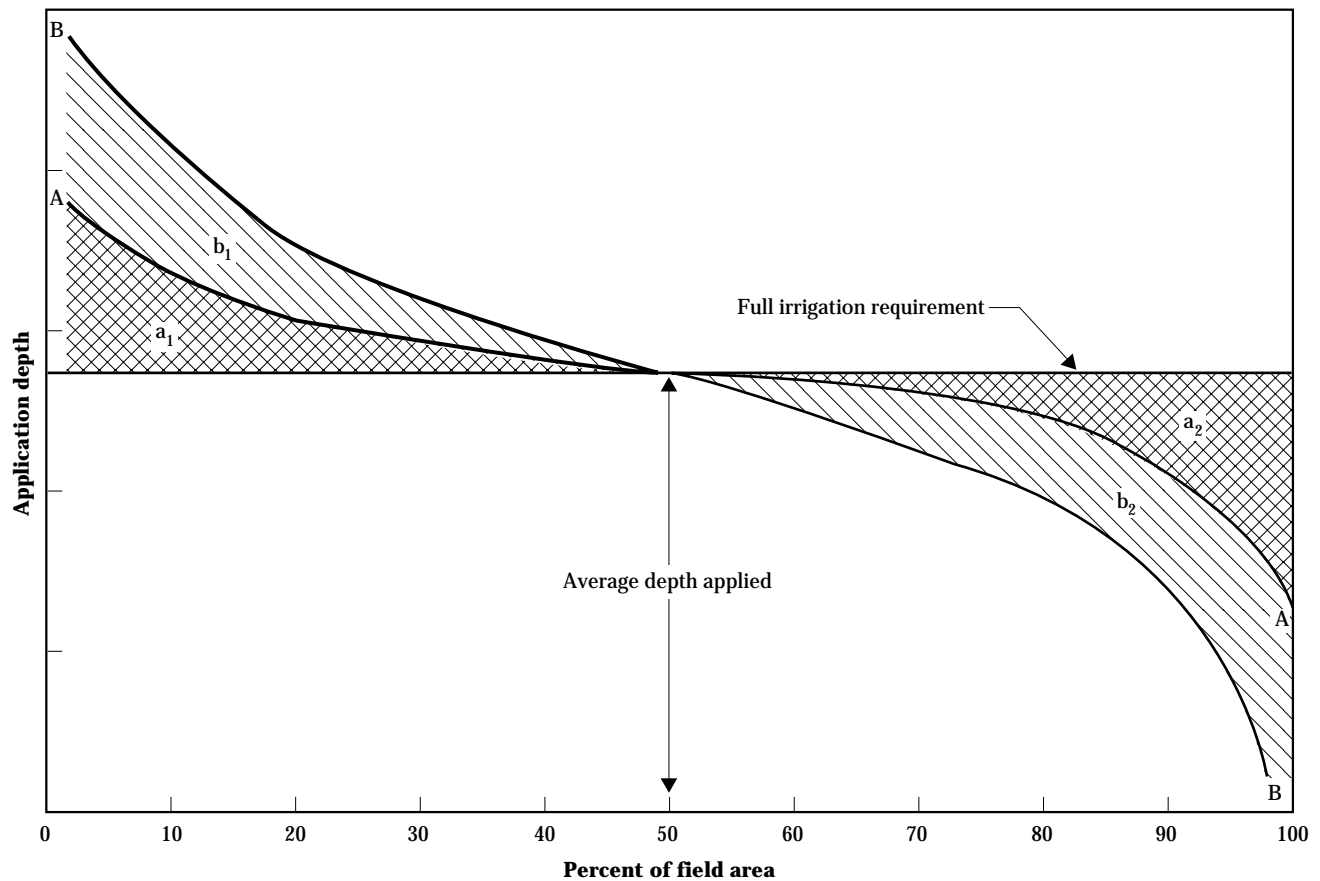

The relationship of adequacy and E_a is shown in figure 2-48. Here, a third system (C) is used that has the same uniformity as system A. System C has a lower adequacy and therefore is not applying sufficient water for the root zone to be filled to field capacity. The amount of over and under irrigation for system A is represented by a_1+c_1 and a_2 , respectively. For system C, this is c_1 and a_2+c_2 , respectively. Because system A has the greater percentage of over irrigation (potential runoff and deep percolation), system C now has the greater E_a . However, improving E_a by decreasing application depth below full irrigation does not necessarily result in a more effective irrigation. Depending on the market value, water-stress sensitivity of the crop, and price of energy and water, this may or may not improve net income.

(2) Sprinkler systems

A concept that combines a measure of uniformity and E_a and provides for adequacy considerations is the Application Efficiency of the Low Quarter (AELQ) or the Application Efficiency of the Low Half (AELH).

AELQ is the ratio of the average of the lowest one-fourth of measurements of irrigation water infiltrated to the average depth of irrigation water infiltrated, expressed as a percentage.
AELH is the ratio of the average of the low one-half of measurements of irrigation water infiltrated to the average depth of irrigation water infiltrated, expressed as a percentage. AELQ and AELH can be measured by conducting field tests of existing systems.

Figure 2-48 Distribution for two irrigation systems having equal uniformity but different adequacy and application efficiency

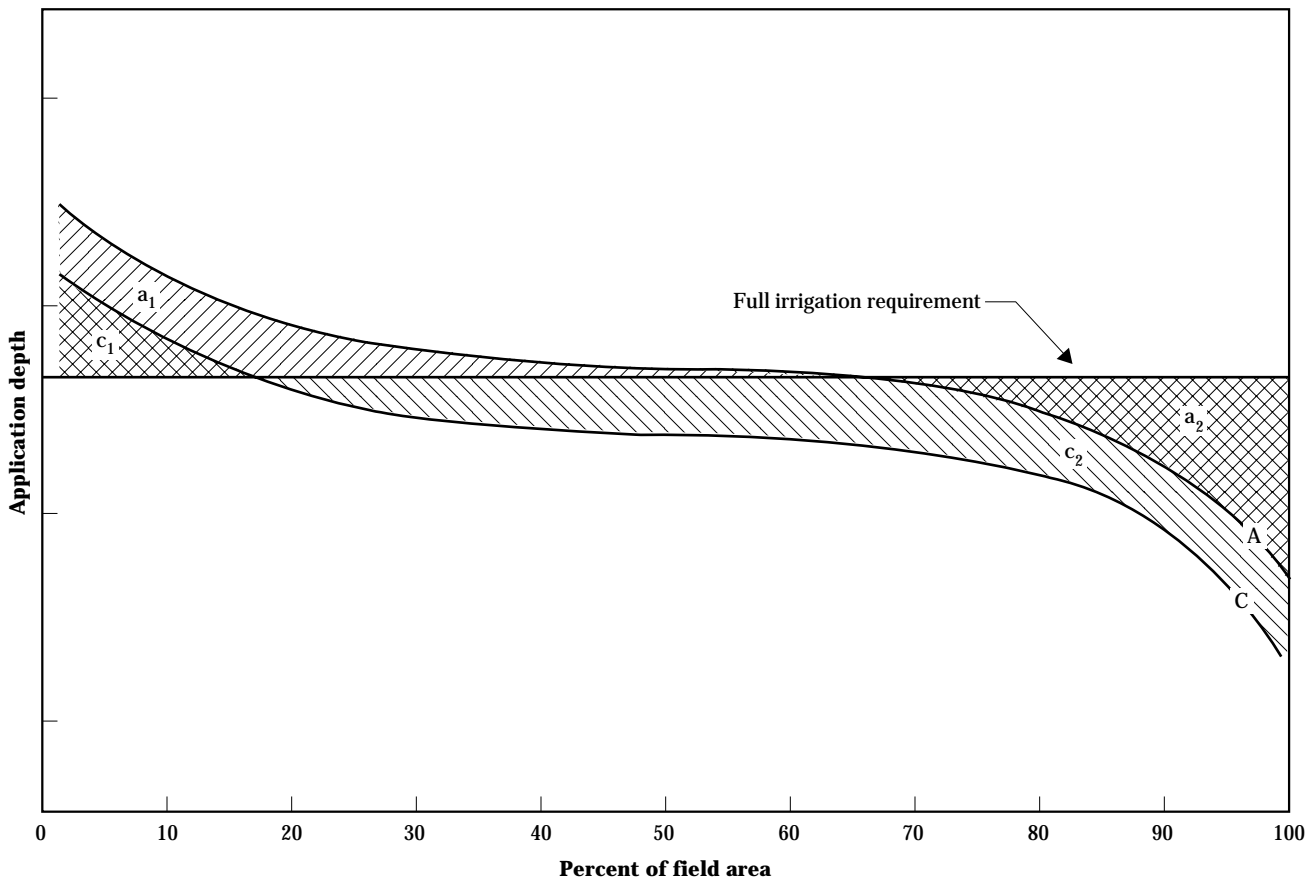

Application efficiencies are termed to be potential when the amount of water applied equals the design amount needed in all areas. This condition seldom exists because of the many variables the irrigation decisionmaker must consider. These variables include under or over estimating soil water needed to refill the plant root zone to field capacity, nonuniform irrigation system application, nonuniform soil characteristics, and nonuniform plant water use.

For sprinkle irrigation systems, potential AELQ can be estimated for design and planning purposes by:

$$\text{potential AELQ} = \text{DU} \times R_e \quad (2-103)$$

where:

- AELQ = application efficiency of the low-quarter (%)
- DU = distribution uniformity (%)
- R_e = effective part of the applied water that reaches the soil surface

R_e is a function of wind drift and evaporation loss and normally varies between 0.8 and 1.0.

To include the consideration of adequacy for medium to high value crops, the gross depth of irrigation water to be applied can be determined by dividing the Soil Moisture Deficit (SMD) by AELQ for the system. This will result in about 10 percent of the total field area receiving less water than needed to reach field capacity with the rest of the field reaching or exceeding field capacity. This is acceptable for medium to high-valued crops, but may be impractical for lower valued crops or irrigation in a water-quality sensitive area. With lower value crops, an application efficiency based on the average low-half of applied depth may be more practical.

For design purposes, the ratio of the average low-half of irrigation water available to the crops to the average depth of water applied to the field (AELH) can be estimated by:

$$\text{potential AELH} = \text{CU} \times R_e \quad [2-104]$$

where:

- AELH = application of efficiency of the low-half (%)
- CU = Christiansen coefficient of uniformity

To include the consideration of adequacy for low to medium value crops, the gross depth of irrigation water to be applied can be determined by dividing the

SMD by AELH. This will result in about 20 percent of the total field area not reaching field capacity after irrigation with the rest at or above field capacity.

A typical range of AELQ and AELH values for various types of sprinkle irrigation systems is shown in table 2-48. These values are based on the assumptions of a fully developed crop canopy and a properly designed and managed sprinkler system that is well maintained. Values will be lower where proper water and system management are not followed.

For sprinkler systems having a CU of more than 60 percent, sprinkle water application generally is distributed normally. Using this fact, Walker (1979) has shown that system application efficiencies can be determined based on the fractional area of the field that is under irrigated (A_u) and the coefficient of uniformity (CU) of water distribution.

The relationship between application efficiency, E_a , and CU is shown in figure 2-49. E_a can be solved explicitly using the following relationship:

$$E_a = 100 \left[1 - (1.25 - 0.0125 \text{ CU}) \left(3.634 - 1.123 A_u^{0.3} + 0.003 A_u^{1.233} \right) \right] \quad [2-105]$$

where:

- E_a = application efficiency (%)
- A_u = fraction of the field that is deficitly irrigated
- CU = coefficient of uniformity

This equation assumes that runoff and in-air losses are negligible.

Table 2-48 Probable application efficiencies of the low-quarter (AELQ) and the low-half (AELH) for various types of sprinkler systems (adapted from the USDA-SCS National Engineering Handbook, Sprinkler irrigation)

System type	AELQ (%)	AELH (%)
Periodic move lateral	60 – 75	70 – 85
Gun or boom sprinklers	50 – 60	60 – 75
Fixed lateral	60 – 85	70 – 88
Traveling sprinklers	55 – 67	65 – 77
Center pivot	75 – 85	80 – 88
Lateral-move	80 – 87	85 – 90

Figure 2-49 Application efficiency as related to the coefficient of uniformity and the percent of the area that is deficitly irrigated

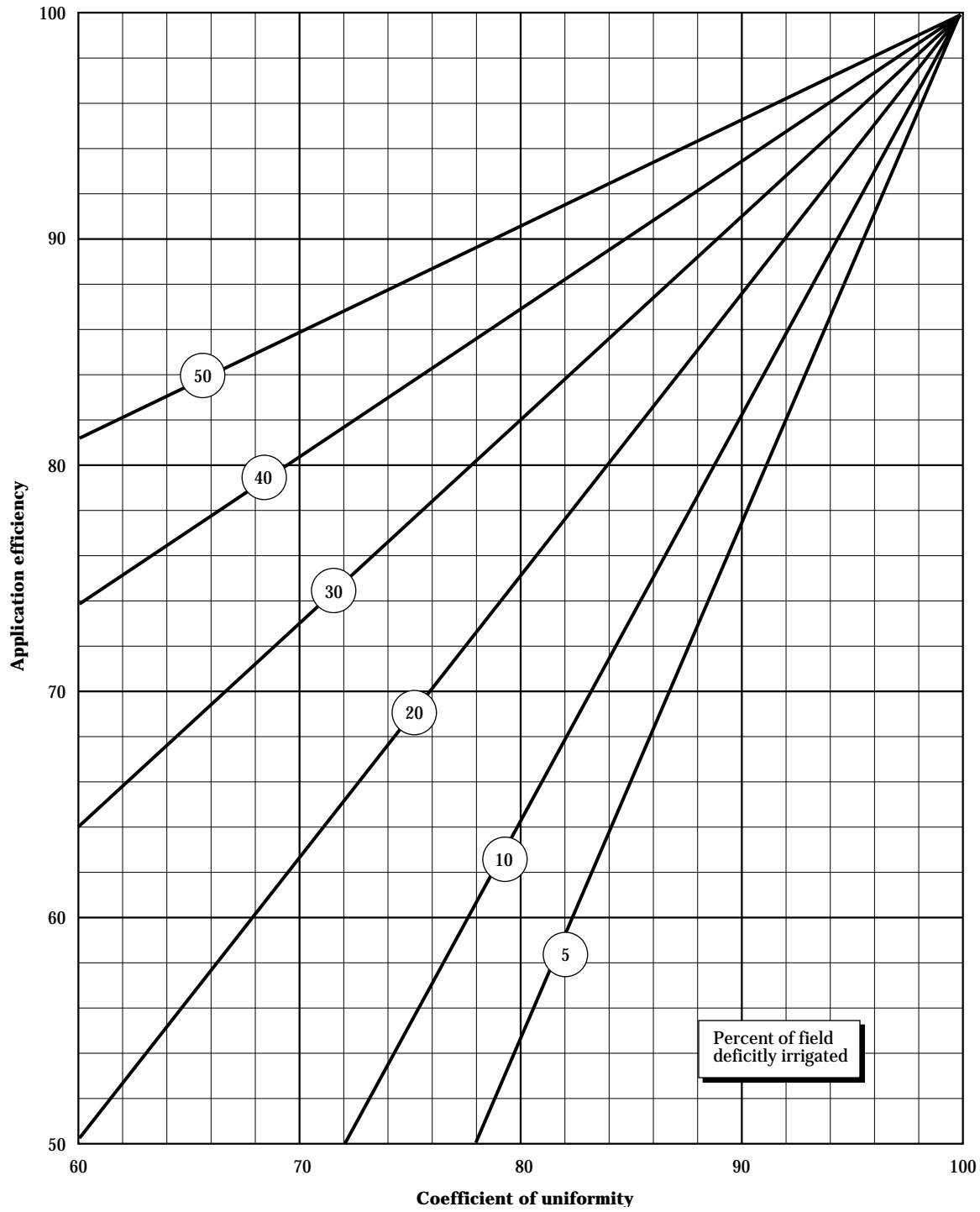

(3) Micro systems

The relationship shown in figure 2-49 can be applied equally well to micro systems (Howell, et al. 1986). Additional information is available from the USDA-SCS National Engineering Handbook, Trickle Irrigation.

(4) Surface systems, graded furrow

Typical values of water application efficiencies for furrow irrigation systems are shown in tables 2-49 and 2-50. These values are for no runoff reuse and for 75 percent runoff reuse respectively. Efficiency values represent the maximum or partial application efficiency that could be typically attained, based on the SCS method of furrow irrigation design and a net depth of application for the end of the furrow. For example, a furrow length was assumed to be 900 feet and furrow spacing 2.5 feet, with a roughness coefficient of 0.04 and constant stream inflow. Maximum set time was 12 hours, and maximum flow rate was based on the maximum nonerosive stream size (i.e., Q_{max} , gpm = 10/slope in percent) for low erosion resistant soils.

Blanks in tables 2-49 and 2-50 represent situations where it was not possible to achieve these conditions. These were mostly soils in SCS furrow intake families of 0.5 or less. Excessive set time is the primary cause. These conditions could not be met for soils in the 0.1 intake family that have slope of more than 0.1 percent at net application, F_n , depth values greater than 2 inches. Therefore, graded furrow irrigation is not recommended on these soils. For intake families greater than 0.5, as slope increases, the stream size required to provide sufficient flow at the end of the furrow typically exceeds the maximum nonerosive stream size. For these conditions, either a shorter furrow length should be used or other irrigation systems considered.

Table 2-49 Example water application efficiencies (%) for furrow irrigation by slope and intake family **assuming no reuse of runoff**^{1/}

Uniform slope (S_o) (ft/ft)	Furrow length = 900 ft			Furrow spacing = 2.5 ft			Manning's $n = 0.04$								
	0.3			0.5			0.7			1.0			1.5		
	Furrow Intake family			Furrow Intake family			Furrow Intake family			Furrow Intake family			Furrow Intake family		
	F_n ^{2/} (in)			F_n ^{2/} (in)			F_n ^{2/} (in)			F_n ^{2/} (in)			F_n ^{2/} (in)		
	2	4	6	2	4	6	2	4	6	2	4	6	2	4	6
level ^{3/}	80	85	85	70	80	80	65	75	80	60	70	75	50	65	70
0.0010												50			50
0.0020					50			50	55		55	60		55	60
0.0030				50	55		50	60	60	50	65	70		65	70
0.0040	50			55	60		55	65		55	70	75		70	75
0.0050	55			60	65		60	70		60	75	80			
0.0075	60			70			70	80			80	85			
0.0100	70			75			75	85							
0.0150	80			85	90				90						
0.0200	85				90										
0.0250	90														
0.0300	90														

1/ Design efficiencies below 70 percent generally are not recommended.

2/ F_n is the desired net depth of application.

3/ Results for level fields assume no runoff (i.e., diked ends).

The data in tables 2-49 and 2-50 provide initial estimates of application efficiencies for furrow systems and were derived using standard USDA-SCS methods (NEH, Furrow Irrigation, 2nd ed.). Many conditions are not represented by these tables. They include more or less erosive soils with associated maximum stream sizes, different set times, different furrow lengths or spacing, cracking soils, nearly level fields, and blocked end furrows. More advanced surface irrigation simulation methods, such as kinematic wave zero-inertia, should be considered. Obviously, consideration of all these factors is beyond the scope of this chapter.

Values in tables 2-49 and 2-50 represent a range of values that are appropriate for initial design and planning for the selected site condition. The final design requires use of standard USDA-SCS methods for furrow irrigation.

Example 2-25 illustrates the use of tables 2-49 and 2-50. A more detailed analysis, including equations and recommended flow rates, is in the USDA-SCS National Engineering Handbook chapter on Furrow Irrigation.

Table 2-50 Example water application efficiencies (%) for furrow irrigation by slope and intake family **assuming a runoff reuse efficiency of 75 percent**^{1/}

Uniform slope (S_o) (ft/ft)	Furrow length = 900 ft			Furrow spacing = 2.5 ft			Manning's $n = 0.04$								
							Furrow Intake family								
							0.7 $F_n^{2/}$ (in)			1.0			1.5		
	2	4	6	2	4	6	2	4	6	2	4	6	2	4	6
level ^{3/}	80	85	85	70	80	80	65	75	80	60	70	75	50	65	70
0.0010	55	60		55	65	65	55	65	65	50	60	65		60	65
0.0020	65	60		60	70	70	60	70	70	55	65	70	50	65	70
0.0030	65	60		65	70	70	65	70	75	60	70	75		65	75
0.0040	70	55		70	75	70	65	75	80	60	70	75		70	75
0.0050	70	55		70	75	70	70	75	80	65	75	80			
0.0075	75			75	80		70	80	85		80	85			
0.0100	75			75	85		75	85	90						
0.0150	80			85	90				90						
0.0200	85				90										
0.0250	90														
0.0300	90														

1/ Design efficiencies below 70 percent generally are not recommended.

2/ F_n is the desired net depth of application.

3/ Results for level fields assume no runoff (i.e., diked ends).

Example 2-25 Determining the gross application for graded furrow irrigation

Given:	Intake family (I_p)	0.5
	Net depth of application (F_n)	4 in
	Furrow slope (S_o)	0.0040 ft/ft
	Roughness coefficient (n)	0.04
	Furrow length	900 ft

Determine: Gross application depth required.

Solution: Using table 2-49, find the column heading for the soil intake family of 0.5 and locate the column for $F_n = 4$ inches. Move downward until you intersect the row having a value of $S_o = 0.0040$ ft/ft in the left most column and read an $E_a = 60$ percent. The gross application depth required is:

$$F_g = 100 \left(\frac{F_n}{E_a \%} \right) = 100 \left(\frac{4 \text{ in}}{60\%} \right) = 6.7 \text{ in}$$

Therefore to ensure that the design net application depth of 4 inches was applied at all locations in the furrow, a gross depth of 6.7 inches must be applied.

If runoff water was reused with an efficiency of 75 percent (i.e., 75% of all runoff was applied back to the same or an adjacent field), then using table 2-50 and the same procedure as above, E_a would equal 75 percent.

$$F_g = 100 \left(\frac{F_n}{E_a \%} \right) = 100 \left(\frac{4 \text{ in}}{75\%} \right) = 5.3 \text{ in}$$

Therefore to ensure that the design net application depth of 4 inches was applied at all locations in the furrow, a gross depth of 5.3 inches must be applied.

(5) Surface systems, graded border

Suggested values of water application efficiencies for graded border irrigation systems as taken from the USDA-SCS National Engineering Handbook chapter on Border Irrigation are shown in table 2-51. These values assume gently sloping, well-leveled fields; adequate facilities for water control and distribution; and proper management. As shown in the table, field application efficiencies are greatest for soils that have a moderate intake rate. Also, as field slope decreases application efficiency increases. Erosion can become a problem where the slope is more than 4 percent.

Border irrigation is not recommended where slope is more than 6 percent. Example 2-26 illustrates the use of table 2-51. As with furrow irrigation, table 2-51 is for planning and initial design. A more detailed analysis, including design equations and recommended flow rates, is in the USDA-SCS National Engineering Handbook chapter on Border Irrigation.

Example 2-26 Use of the application efficiency table (table 2-51) for graded border irrigation

Consider: Intake family (I_p) 1.0
 Net depth of application 4 inches
 Field slope (S_o) 0.0010 ft/ft

Determine: Gross application depth required.

Solution: Using table 2-51, find the column corresponding to an intake family of 1.0 and net application depth of 4 inches. Move down this column until you intersect the row for S_o of 0.0010 ft/ft and read an efficiency of 75 percent. The gross application depth required is:

$$F_g = 100 \left(\frac{F_n}{E_a \%} \right) = 100 \left(\frac{4 \text{ in}}{75\%} \right) = 5.3 \text{ in}$$

Therefore to ensure that the design net application depth of 4 inches was applied at all locations in the field, a gross depth of 5.3 inches must be applied.

Table 2-51 Suggested application efficiency for graded border irrigation systems

Field slope, S_o (ft/ft)	0.3					0.5					1.0					1.5					2.0					3.0					4.0																												
	1					2					3					4					5					1					2					3					4																		
	3					4					5					1					2					3					4					5					1					2					3					4			
Net depth of irrigation (F_b), in																																																											
0.0005	65	65	70	70	70	65	65	70	70	70	75	75	80	80	80	75	75	80	80	80	75	75	80	80	80	75	75	80	80	80	65	70	70	70	70	65	70	70	70	70	65	70	70	70	70	65	70	70	70	70									
0.0010	60	60	65	65	70	70	65	65	70	70	70	70	70	75	75	75	75	75	80	80	80	75	75	80	80	80	75	75	80	80	80	65	70	70	70	70	65	70	70	70	70	65	70	70	70	70	65	70	70	70	70								
0.0020	60	60	55	50	70	70	65	65	70	70	70	65	65	70	70	75	70	70	75	75	75	70	70	75	75	75	70	70	75	75	75	65	70	70	70	70	65	70	70	70	70	65	70	70	70	70	65	70	70	70	70								
0.0030	55	55	50	50	60	60	60	60	65	65	65	65	65	70	70	70	65	65	70	70	70	65	65	70	70	70	65	65	70	70	70	65	70	70	70	70	65	70	70	70	70	65	70	70	70	70	65	70	70	70	70								
0.0040	55	50	50	50	60	60	60	60	65	60	55	60	60	65	65	65	65	65	70	70	70	65	65	70	70	70	65	65	70	70	70	65	70	70	70	70	65	70	70	70	70	65	70	70	70	70	60	65	65	65	65								
0.0050	50	50	50	50	60	60	60	60	60	55	50	60	60	65	65	65	65	65	70	70	70	65	65	70	70	70	65	65	70	70	70	65	70	70	70	70	65	70	70	70	70	65	70	70	70	70	60	65	65	65	65								
0.0075	55	55	50	50	60	60	55	55	50	50	50	60	60	65	65	65	60	60	65	65	65	65	65	70	70	70	65	65	70	70	70	65	70	70	70	70	65	70	70	70	70	65	70	70	70	70	60	65	65	65	65								
0.0100	55	55	50	50	60	60	55	55	50	50	50	60	60	65	65	65	60	60	65	65	65	60	60	65	65	65	60	60	65	65	65	60	65	65	65	65	60	65	65	65	65	60	65	65	65	65	60	65	65	65	65	60	65	65	65	65			
0.0150	55	55	50	50	60	60	55	55	50	50	50	60	60	65	65	65	60	60	65	65	65	60	60	65	65	65	60	60	65	65	65	60	65	65	65	65	60	65	65	65	65	60	65	65	65	65	60	65	65	65	65	60	65	65	65	65			
0.0200	50	50	50	50	60	60	55	55	50	50	50	60	60	65	65	65	60	60	65	65	65	60	60	65	65	65	60	60	65	65	65	60	65	65	65	65	60	65	65	65	65	60	65	65	65	65	60	65	65	65	65	60	65	65	65	65			
0.0250	55	55	50	50	60	60	55	55	50	50	50	60	60	65	65	65	60	60	65	65	65	60	60	65	65	65	60	60	65	65	65	60	65	65	65	65	60	65	65	65	65	60	65	65	65	65	60	65	65	65	65	60	65	65	65	65			
0.0300	55	55	50	50	60	60	55	55	50	50	50	60	60	65	65	65	60	60	65	65	65	60	60	65	65	65	60	60	65	65	65	60	65	65	65	65	60	65	65	65	65	60	65	65	65	65	60	65	65	65	65	60	65	65	65	65			
0.0400	50	50	50	50	60	60	50	50	50	50	50	60	60	65	65	65	60	60	65	65	65	60	60	65	65	65	60	60	65	65	65	60	65	65	65	65	60	65	65	65	65	60	65	65	65	65	60	65	65	65	65	60	65	65	65	65			
0.0500	55	55	50	50	60	60	55	55	50	50	50	60	60	65	65	65	60	60	65	65	65	60	60	65	65	65	60	60	65	65	65	60	65	65	65	65	60	65	65	65	65	60	65	65	65	65	60	65	65	65	65	60	65	65	65	65			
0.0600	50	50	50	50	60	60	50	50	50	50	50	60	60	65	65	65	60	60	65	65	65	60	60	65	65	65	60	60	65	65	65	60	65	65	65	65	60	65	65	65	65	60	65	65	65	65	60	65	65	65	65	60	65	65	65	65			

(6) Surface systems, level furrow, border, or basins

In level furrow, border, or basin irrigation, fields are divided into level, generally rectangular areas surrounded by dikes or ridges. During irrigation, water is turned in at one or more points as needed until the gross volume of water required to infiltrate the desired net depth of application at all points in the field has been discharged. Because there is no runoff, application efficiencies are normally quite high as long as deep percolation losses are minimized. Level furrow, border, or basin systems are the easiest irrigation systems to manage.

Level furrow, border, or basin irrigation works best with soils that have a low to moderate intake rate. Level systems can be adapted to soils that have a high intake rate, but the length of run must be shortened to prevent excessive deep percolation near the inflow points. Applying large irrigation depths with these systems on soils that have a very low infiltration rate is not advised. The soil surface may be inundated for a considerable period to infiltrate the large water application, which can lead to poor soil aeration or crop scalding, stunting, or death.

Table 2-52 Design application efficiency of level systems as function of the advance ratio AR, where
 $AR = \text{advance time/net opportunity time}$
 $= T_t/T_n^{1/2}$

Design application efficiency $E_a = \%$	Advance ratio $AR = T_t/T_n^{1/2}$
95	0.16
90	0.28
85	0.40
80	0.58
75	0.80
70	1.08
65	1.45
60	1.90
55	2.45
50	3.20

1/ A design application efficiency below 70 percent is not recommended.

The design application efficiency for level systems generally is recommended to be at least 80 percent. To ensure this, flow rates should be large enough to completely cover the area within 60 to 75 percent of the time required for the design application depth to infiltrate (table 2-52). A design application efficiency of 70 percent is only appropriate for clean water and soils that have good internal drainage so that excess water that can cause crop damage drains from the root zone.

Experience may show, with some soils or crops, advance time can be decreased by having a very low in-row gradient within the level area (and with no side fall). By SCS definition, level furrow, border, and basin irrigation systems can have a total fall for the length of run of up to one-half the net depth of irrigation, F_n . For example, a 1,300 foot length of run can have up to 2 inches total fall ($S_o = 0.000128$ ft/ft) if $F_n \geq 4.0$ in.

(7) Subsurface systems, water table control, subirrigation

With subsurface irrigation, plants use water from a shallow water table that either occurs because of the natural site conditions or is developed and maintained by introduction of water. Upon soil profile drying by evaporation from the soil surface or transpiration from plants, a water potential gradient develops that allows water to move upward in the soil profile and be taken up by plant roots. See part 623.0208, Water table contribution.

The water table must be maintained at a depth below the soil surface so that upward flux of water in the soil profile is maintained. Before the water table reaches a critical elevation, water is added by use of properly spaced open channels or buried conduits. These open channels and buried conduits act as a drainage system and as an irrigation water distribution system. Overall, less irrigation water is needed as more effective use is made of rainfall and fewer losses can occur. Adequate surface drainage and subsurface drainage for water table control are essential to obtain good irrigation efficiencies. Most efficient water use is obtained where the water table is managed at the deepest depths that will provide moisture to the plant roots because evaporation from soil surface decreases as the depth of water table increases.

Equations 2-1, 2-8, 2-83, and 2-106 provide the process for evaluating the water balance for the desired period of evaluation. The most difficult item to determine in the water balance equations 2-1 and 2-8 is deep percolation below the crop root zone, which would also include lateral movement losses. With proper design and installation on suitable sites, a subsurface irrigation system can have quite a high overall irrigation efficiency. Proper operation and management are essential. Because of the wide variability of site conditions and systems, reference to local irrigation and drainage guides is suggested for design and operation of subsurface irrigation systems.

(f) Conveyance efficiency (E_c)

Conveyance efficiency (E_c) is the ratio of the water delivered to the total water diverted or pumped into an open channel or pipeline at the upstream end, expressed as a percentage.

In the Western States, an estimated one-third to one-half of the water diverted for irrigation is lost between the source and the point of use. A large percentage of this water is lost because of leakage and operational spills in conveyance systems. These losses can occur both on the farm and in group owned facilities. Conveyance losses result primarily from

- Seepage from ditches, canals, and pipelines
- Leakage through and around headgates and other structures
- Operational spills
- Consumptive use by phreatophytes

Some loss in conveyance is unavoidable. However, losses may be greatly reduced by lining earth ditches and canals or converting to pipelines; by repairing and maintaining canals and pipelines, headgates, and other structures; and by destroying or removing undesirable phreatophytes near or in the delivery system. Conveyance losses can serve as local ground water recharge or for maintaining artificial wetlands. Reduction of conveyance losses should be weighted against the affects of cutting off the water source to those other uses. Mitigation may be required.

Significant losses of water can also occur if the delivery system is not properly operated and undesirable spills occur in the system. The conveyance loss should be known to design, operate, and renovate delivery

systems. On existing systems, it may be necessary to determine the actual conveyance loss and location.

The primary water loss in many conveyance or delivery systems is less than optimum water management. Up to 50 percent of water carried may be *management* or *pass through* water. Often this water is used or wasted on fields near the lower end of the delivery system, causing over irrigation. Water required for management can be reduced significantly by using automated water, electric, or pneumatic self actuating control valves and headgates. Discharge rates are controlled by either upstream or downstream sensors.

Losses of water during operation of the delivery system can occur in several ways that vary from project to project. Some water may be lost when closing or opening control elements. Other losses occur if the irrigator does not use all the water for all the time delivered by the supplier and allows the surplus to pass through. An example of this loss becoming significant occurs when a general rain occurs in the project area after water has been released upstream for use. Often an irrigation water supplier carries unaccounted for management water. On large projects with normal management, regulatory losses can vary from 5 to 50 percent of the diversion. These losses can generally be maintained below 10 percent on carefully managed, manually operated projects. Automation technology is available to reduce losses even further.

Another primary water loss is seepage from unlined canal systems constructed through highly permeable soils, gravel, and rock. Seepage occurs because of the combined action of the forces of gravity and the attraction of soil for water. The force of the attraction of soil for water dominates where water is first turned into an earthen canal. The attraction for water is both horizontal and vertical in the soil surrounding the canal. For example, the soil's attraction for water may cause water to rise in the soil adjacent to the canal to a height above the water level in the canal. Consequently, the canal can lose a large amount of water because of capillary forces of the soil around the canal.

After water has been supplied to the canal for a period of time, a primary means of water loss through the soil is steady state seepage. Seepage can be vertical or horizontal depending on the hydraulic properties of the soil underlying the canal. If soils below the canal

have a high unsaturated conductivity, the seepage from the canal will move primarily vertically downward. If a layer of soil with low hydraulic conductivity is below the canal, the seepage may spread laterally perpendicular to the canal. If a water table is close to the bottom of the canal, the water will also spread laterally to a great extent.

The rate of seepage is determined by the hydraulic conductivity of the soil in and around the canal and by the head available. If the soil surrounding the canal is a nonfracturing clay, the conductivity is generally very low and the conveyance loss could be expected to be quite low. If a canal cuts through a sandy, gravelly, or porous rock region, the conveyance loss could be very high in the affected region. The hydraulic head available for seepage from the canal depends on the height of water in the canal and the depth to a permanent or perched water table.

Other factors also affect the seepage losses from canal systems:

- Length of time the canal is in operation
- Amount of turbidity and sediment in canal water
- Temperature of the water and the soil
- Barometric pressure
- Salt concentration of the water and soil
- Amount of entrained air in the water and soil
- The presence of certain biological factors

Because all of these factors act simultaneously and some counteract the effects of others, the effect of all variables on the rate of seepage from a canal is difficult to predict.

Seepage loss from pipelines and lined canals depends on the type of pipe or lining used and the care taken when installing and maintaining the delivery system. If properly selected, installed, and maintained, the seepage losses through pipelines and linings generally are insignificant. Seepage losses through pipelines and lined canals often occur at faulty or broken sections of the system. Conveyance losses can also occur around gates, valves, turnouts, and other structures. However, if the structures are properly installed and maintained, these losses should also be minimal.

Considerable quantities of water can be lost to the consumptive use of phreatophytes and hydrophytes that grow in and next to the canal, especially in un-

lined canals. If the density of these plants becomes too intense or if they obstruct flow, corrective actions are generally required. For example, weeds in the canal can cause increased resistance to flow and reduced canal capacity. Also, if the weeds begin to float in the canal, they can eventually accumulate in a control structure and lead to control restrictions. If these water-loving plants cannot be eliminated or their presence is desirable, their consumptive use must be accounted for in the design and operation of the project.

The amount of water lost during conveyance can be measured on existing systems to estimate the efficiency. It may be possible to measure losses in prototype systems during the final design stages of a delivery system. In many cases the water loss during conveyance must be predicted. The most advanced methods of prediction use the soil's hydraulic properties at the canal location to solve complex flow equations through saturated and unsaturated media. If that information is not available or if time is not available to conduct detailed analysis, the conveyance efficiency can be estimated for representative systems. While this section is not a design guide for conveyance systems, the essence of these techniques is considered.

(1) Measuring conveyance efficiency

Four methods are commonly used to predict the conveyance efficiency for existing canals or when testing designs for proposed delivery systems. These methods are ponding tests, inflow-outflow tests, seepage metering, and hydraulic simulation. Each method has advantages and disadvantages, and no single method is better than any other. Unfortunately, none of the methods can be considered a standard that is extremely accurate. Two studies analyzed methods of measuring seepage losses and concluded that all methods can produce highly variable estimates (Hotes, et al. 1985 and Frevert and Ribbens 1988). However, the methods described below are the best techniques available and should be carefully conducted for dependable results.

Ponding test—A ponding test is commonly used on existing canal systems. This test is conducted by filling a reach of a canal to a depth greater than the normal flow depth. The rate of decline of the water level in the canal is recorded over time. The volume of seepage per unit of wetted surface area in the canal per unit of

time can be computed to determine the seepage rate. Units generally are cubic feet per square foot per day. The rate of decline can then be prorated over similar reaches of the canal for the duration of the desired delivery. This gives an estimate of the amount of water that will be lost from the canal. The ponding test can also be conducted by adding known amounts of water to the canal to maintain a constant water level in the reach.

The ponding test has several disadvantages. The test cannot be conducted when the canal is supplying water for irrigation. Thus it must be completed before the start or after the end of the irrigation. The seepage rate from the ponded test may be inappropriate for the entire season because it can vary significantly over the irrigation period. The water in the pond is generally stagnate. Flowing water can affect the seepage rate of some soils. In addition the ponding test can be expensive if special dikes and bulkheads are necessary to restrict the flow. Filling the ponding test area can also be very involved when the irrigation project is not in operation.

Inflow-outflow method—The inflow-outflow method uses flow measurements at upstream and downstream locations along the canal to determine the losses in that reach of the canal. The inflow-outflow method can be easily used in canals where flow measuring devices have been designed into the system. All diversions and any input from rain must be considered when using the inflow-outflow method. The accuracy of the method generally improves with the length of the test and accuracy of the measuring structures.

Various methods of measuring flow in open channels have been developed that can work for the inflow-outflow method (Replogle and Bos 1982). Construction and installation of the flow measuring equipment can be expensive.

Seepage meter method—A seepage meter can be used to measure the seepage rate through very small parts of the canal system. The meter includes a small cylindrical bell. The open end of the bell is forced into the bottom or side of a canal. The closed end is connected to a water supply outside the canal. The hydraulic head of the water supply to the bell is maintained at the water level in the canal or is allowed to free fall. The rate that water seeps through the bell is

measured and converted to an equivalent seepage rate for the canal.

The advantage of using a seepage meter is that it can be installed in flowing canals and is the simplest and least expensive test to conduct. However the accuracy of the test is very dependent on the installation of the meter. If the meter significantly disturbs the canal, a large error can result. Results from the seepage meter should only be applied to similar sections of the canal. The meter generally is limited to use in earthen canals in which the soil is suitable to form a seal around the bell as it is forced into the soil. The seepage meter can be washed away in sandy or gravelly soils.

Hydraulic simulation method—A hydraulic simulation method can be used to estimate the rate of seepage from a canal. It can be applied either before or after the canal has been constructed. This method depends on accurately measuring the soil's hydraulic properties in and around the canal. These properties are used in simulation models of the waterflow through saturated and unsaturated media to estimate the seepage loss (Bouwer 1988).

The advantage of using a hydraulic model is that various canal locations and designs can be readily evaluated before they are in place. The model also can simulate long-term conditions that may be impossible with other methods. This can be important if a soil layer below the canal limits seepage rather than those near or on the floor of the canal.

(2) Estimating conveyance efficiencies

Because measuring water losses in canals and other delivery systems can be difficult and inexact, the conveyance efficiency generally can be estimated for initial design and planning of irrigation projects. Several efficiency terms have been used depending on where the delivery system is located. Doorenbos and Pruitt (1977) divide the efficiency of an irrigation project into three components: supply conveyance efficiency (E_c), field canal efficiency (E_b), and field application efficiency (E_a). Conveyance efficiency and field canal efficiency are sometimes combined and called the distribution efficiency (E_d), where $E_d = E_c \times E_b$. The combination of the field canal and application efficiencies is often called the farm efficiency (E_f), where $E_f = E_a \times E_b$. The application efficiency can be estimated from the methods described earlier in this section.

Factors affecting conveyance efficiency include

- the size of the irrigated area,
- type of delivery schedule used to deliver water,
- the crops, the canal lining material, and
- the capabilities of the water supplier.

The field canal conveyance efficiency is primarily affected by the method and control of operation, the type of soils the canal transects, the length of the canal, and the size of the irrigated block and fields.

The farm efficiency is very dependent on the operation of the supply system relative to the supply required on the farm. Doorenbos and Pruitt (1977) present approximate efficiencies for various conditions as summarized in table 2-53.

A procedure used in the Washington State Irrigation Guide can also be used to estimate seepage losses (USDA 1985). The method gives a range of expected seepage losses depending on the transport material in the delivery system (figure 2-50). The range is dependent on the amount of fines in the material. In addition, the following losses may be expected:

Ditchside vegetation	0.5-1% loss per mile
Buried pipeline	0.01 – 0.15 ft ³ /ft ² , depending on the age and type of pipe.

Example 2-27 shows the calculations for seasonal water loss in an earthen ditch.

Example 2-27 Seepage loss

Given:	Soil	Loam
	Ditch length	1,320 ft.
	Flow area	2.5 ft ² /ft (measured wetted perimeter)
	Time	water in the ditch 180 days
	Stream size	2.5 ft ³ /s

Determine: Seasonal water loss

Solution: Use figure 2-50 to find the seepage loss of a loam soil:
= 1.23 ft³/ft²/d

Use average values to compute the seepage loss:

$$= \frac{\text{Flow Area} \times \text{Length} \times \text{Loss} \times \text{Time}}{43,560 \text{ ft}^2 / \text{acre}}$$

$$= \frac{2.5 \times 1320 \times 1.23 \times 180}{43,560} = 16.8 \text{ acre feet}$$

Vegetation loss at 1 percent of the total flow for the period per mile:

$$= \% \times \text{Flow} \times \text{Days} \times \text{Length (miles)} \times 2 \text{ acre ft/ft}^3/\text{s/d}$$

$$= 0.01 \times 2.5 \times 180 \times 1320/5280 \times 2$$

$$= 2.25 \text{ acre feet}$$

Total loss = Seepage loss + Vegetation loss
= 16.8 + 2.25 = 19.1 ac ft/yr

The accuracy with this method is no better than 0.5 acre feet, so the estimated loss is 19 acre feet per year.

Table 2-53 Conveyance, field, and distribution efficiencies for various types of systems (from Doorenbos and Pruitt 1977)

Characteristics	Efficiency
Project characteristics	Conveyance efficiency
Continuous supply with no substantial change in flow	90%
Rotational supply for projects with 7,000 to 15,000 acres and rotational areas of 150 to 800 acres and effective management	80%
Rotational supply for large projects (> 25,000 acres) and small projects (< 2,500 acres) with problematic communication and less effective management:	
Based on predetermined delivery schedules	70%
Based on arranged delivery schedules	65%
Irrigation field characteristics	Field efficiency
Irrigated blocks larger than 50 acres with:	
Unlined canals	80%
Lined canals or pipelines	90%
Irrigated blocks smaller than 50 acres with:	
Unlined canals	70%
Lined canals or pipelines	80%
For rotational delivery systems with management and communication adequacies of:	Project/district distribution efficiency
Adequate	65%
Sufficient	55%
Insufficient	40%
Poor	30%

Figure 2-50 Method to estimate seepage losses from irrigation delivery systems (adapted from USDA 1985)

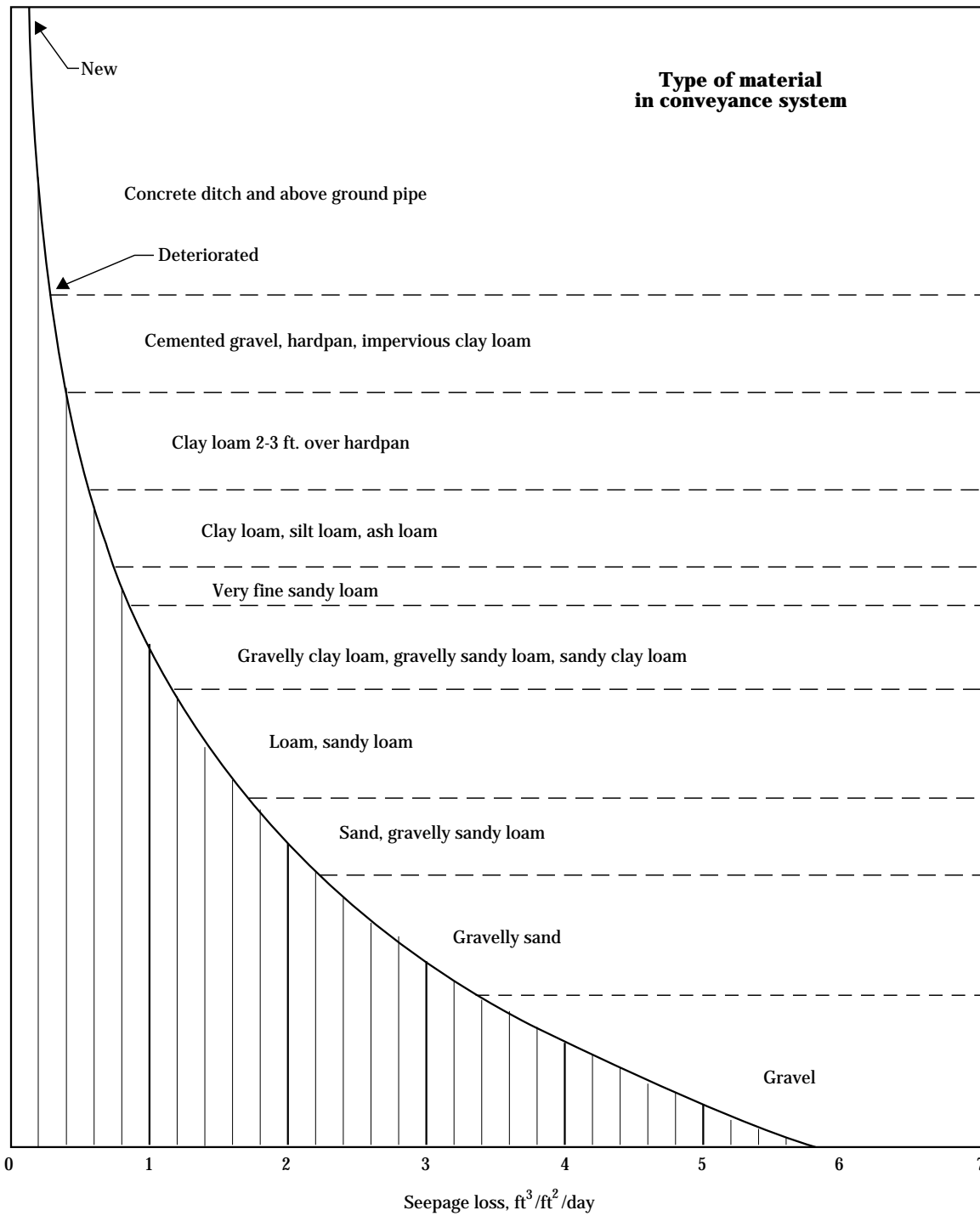

623.0210 Onfarm irrigation requirements

(a) Net seasonal irrigation requirements

(1) Leaching not required

Predicting the seasonal irrigation requirement is important in planning and designing irrigation systems, allocating water supplies, and managing irrigation in saline areas. For those areas where salinity is not a problem, the determination of net irrigation can be calculated by rearranging the soil water balance in equation 2-83:

$$F_n = ET_c - P_e - GW - \Delta SW \quad [2-106]$$

where:

- F_n = net irrigation requirement for the season
- ET_c = crop evapotranspiration during the season
- P_e = effective precipitation during the season
- GW = ground water contribution during the season
- ΔSW = soil water depleted during the season

The time step used to calculate F_n ranges from a daily to a monthly basis. For planning purposes, a monthly basis is generally used. However, with the widespread use of personal computers, a daily water balance is often used in the many calculations required to evaluate each of these terms. A monthly water balance is used in example 2-28 to illustrate the combined procedure.

Example 2-28 Seasonal irrigation requirement when leaching is unnecessary

Given: A sandy loam soil that has a water table 5 feet below the crop root zone. The root zone is 4 feet deep. Salinity is not a problem. Average annual precipitation is 24 inches.

The field is irrigated with a center pivot irrigation system equipped with low-angle impact sprinklers. The normal application depth is 1.25 inches of water per irrigation, and the application efficiency is 80 percent. The crop is irrigated when the soil water depletion is 50 percent. The crop is generally irrigated twice per week in July and August and once per week in June and September.

Corn is generally planted on May 1 and harvested on October 1. Basal crop coefficients for the crop were calculated in section 623.0204(b).

Average monthly data

Month	ET_o (in/mo)	Precipitation (in/mo)	Interval between rains (d)	Basal crop coefficient
May	5.6	3.6	6	0.25
June	7.2	4.6	7	0.76
July	8.4	2.9	8	1.20
August	7.1	3.3	6	1.20
September	4.9	3.1	10	0.68

Find: Determine the monthly and seasonal irrigation requirement.

Example 2-28 Seasonal irrigation requirement when leaching is unnecessary—Continued

Solution: 1. Compute the monthly crop evapotranspiration (ET_c)

$$ET_c = K_a ET_o$$

- Compute the average monthly crop coefficient using equation 2-66.

$$K_a = \overline{K_s K_{cb}} + F_w (1 - \overline{K_{cb}}) A_f$$

- Because the soil is irrigated at 50 percent depletion, it is not effected by water stress and $K_s = 1.0$.
- The mean value of K_{cb} can be taken as the value of K_{cb} at the middle of the month as computed in 623.0204(b) and listed above.
- For a center pivot that has impact sprinklers, $F_w = 1.0$.
- Values of A_f are in table 2-30. They depend on the wetting frequency and the soil type. For the irrigation and rainfall frequencies given above and the sandy loam soil, the values of A_f are:

Month	Minimum wetting interval (days)	A_f
May	6	0.321
June	7	0.275
July	4	0.482
August	4	0.482
September	7	0.275 - irrigated once a week

- The average crop coefficient (K_a) and crop evapotranspiration (ET_c) for the months are:

Month	K_a	ET_o in/mo	ET_c in/mo
May	0.49	5.6	2.7
June	0.83	7.2	6.0
July	1.20	8.0	9.6
August	1.20	7.0	8.4
September	0.77	4.9	3.8

Example 2-28 Seasonal irrigation requirement when leaching is unnecessary—Continued

2. Calculate the effective precipitation.

- Use ET_c rates and rainfall amounts to calculate effective precipitation for an irrigation application of 1.25 inches. As an example for May, ET_c for corn = 2.7 inches and rain is 3.6 inches. From table 2-43, or equation 2-84, the effective precipitation is 2.24 inches.
- Multiply that value by the factor (0.77) for a 1 inch net irrigation application (equation 2-85). (Note: 1.25 inch gross irrigation times an 80 percent application efficiency = 1.0 inch.) The effective precipitation for May is 1.72 inches. Values for other months are summarized below.

Average monthly effective precipitation

Month	ET_o (in)	ET_c (in)	P_e (in)
May	5.6	2.7	1.7
June	7.2	6.0	2.6
July	8.4	9.6	2.1
August	7.1	8.4	2.2
September	4.9	3.8	1.6
Total		30.5	10.2

3. Upward flow rate for soil type 6 and a water table 5 feet deep is about 0.02 inch per day (fig. 2-42). Thus, upward flow for May through September will be about:

$$0.02 \text{ in/d} \times 153 \text{ d} = 3 \text{ in.}$$

4. Soil moisture mining for a 4-foot deep root zone and 50 percent depletion will be about:

$$4 \text{ ft} \times 0.5 \times 1.5 \text{ in/ft} = 3 \text{ in}$$

5. Net irrigation requirement:

$$F_n = ET_c - P_e - GW - \Delta SW$$

$$F_n = 30.5 - 10.2 - 3 - 3 = 14.3 \text{ in}$$

6. Gross irrigation requirement:

$$F_g = \frac{F_n}{E_a} = \frac{14.3}{0.8} = 17.9 \text{ in}$$

(2) Leaching required

Example 2-29 examines the same conditions except it includes salinity control.

Example 2-29 Seasonal irrigation requirement when leaching is needed

Given:	Average annual surface runoff from rainfall (SP_a)	= 1.0 inch
	Surface evaporation in nongrowing season (E_{os})	= 3.0 inches
	Electrical conductivity of the irrigation water (EC_i)	= 3.0 mmho/cm
	Salt tolerance threshold of corn (EC_t from table 2-34)	= 1.7 mmho/cm
	Center pivot system with no runoff of irrigation water (F_{ro})	= 0.0

Find: Determine the gross irrigation requirement.

Solution: Calculation of leaching requirement (L_r):

1. Use EC_t/EC_i to obtain an initial estimate of L_r .

$$\frac{EC_t}{EC_i} = \frac{1.7}{3.0} = 0.57$$

Using curve 3 in figure 2-33, an initial estimate of L_r is 0.28.

2. Calculate F_i using equation 2-77 with P_{net} computed using equation 2-78

$$P_{net} = P_a - SP_a - E_{os}$$

$$P_{net} = 24.0 - 1.0 - 3.0 = 20 \text{ in}$$

Then using equation 2-77 gives:

$$F_i = \frac{ET_c}{1 - L_r} - P_{net} = \frac{30.5}{1 - 0.28} - 20 = 22.4$$

3. Calculate EC_{aw} (equation 2-79).

$$\begin{aligned} EC_{aw} &= \frac{EC_i F_i}{(F_i + P_{net})} \\ &= \frac{3.0(22.4)}{(22.4 + 20)} = 1.58 \end{aligned}$$

4. Calculate EC_t/EC_{aw} .

$$\frac{EC_t}{EC_{aw}} = \frac{1.7}{1.58} = 1.08$$

From figure 2-33, $L_r = 0.17$.

5. Go to step 2 and repeat calculations.

$$F_i = \frac{ET_c}{1 - L_r} - P_{net} = \frac{30.5}{1 - 0.17} - 20 = 16.7$$

Example 2-29 Seasonal irrigation requirement when leaching is needed—Continued**Solution** (cont.):

6. New
- EC_{aw}
- value.

$$EC_{aw} = \frac{EC_i F_i}{(F_i + P_{net})}$$

$$= \frac{3.0(16.7)}{(16.7 + 20)} = 1.37$$

7. Determine ratio of
- EC_t
- to
- EC_{aw}
- .

$$\frac{EC_t}{EC_{aw}} = \frac{1.7}{1.37} = 1.24$$

$$L_r = 0.15$$

$$F_i = 15.9 \text{ in}$$

8. New
- EC_{aw}
- value.

$$EC_{aw} = \frac{3(15.9)}{(15.9 + 20)} = 1.33$$

$$\frac{E_t}{EC_{aw}} = \frac{1.7}{1.33} = 1.28$$

$$L_r = 0.14$$

$$F_i = 15.5 \text{ in}$$

$$EC_{aw} = 1.31$$

Because the value of EC_{aw} is essentially the same for this iteration as that for the previous one, calculation of L_r and F_i can stop.

9. Calculation of gross irrigation from equation 2-80.

$$F'_g = \frac{F_i}{(1 - F_{ro})} = \frac{15.5}{(1 - 0)} = 15.5 \text{ in}$$

Thus, salinity control under these conditions requires only 15.5 inches of gross irrigation.

Example 2-29 Seasonal irrigation requirement when leaching is needed—Continued

10. Calculate the gross irrigation required to meet crop evapotranspiration using equation 2-81.

$$F_g = \frac{(ET_c - P_e)}{E_a} = \frac{(30.5 - 10.2)}{0.8} = 25.4 \text{ in}$$

Thus in this case the irrigation requirements are determined by ET_c demands and not salinity control. A check of the procedure with this value of gross irrigation should be made to ensure accuracy:

$$EC_{aw} = \frac{3.0(25.4)}{(25.4 + 20)} = 1.68 \text{ mmho / cm}$$

$$\frac{E_t}{EC_{aw}} = \frac{1.7}{1.68} = 1.01$$

$$L_r = 0.18$$

$$F'_g = \frac{F_i}{(1 - F_{ro})} = \frac{17.2}{(1 - 0)} = 17.2 \text{ in}$$

As F_g is $> F'_g$, seasonal ET_c determines the gross irrigation requirements.

Now evaluate a situation for an arid area where salinity management determines the gross irrigation requirement (example 2-30).

Example 2-30 Seasonal irrigation requirement for an arid area

Given: Corn crop evapotranspiration = 26.0 inches
 $EC_t = 1.7$ mmho/cm
 $EC_i = 2.0$ mmho/cm
 Center pivot irrigation with 10 percent runoff ($F_{ro} = 0.10$)
 $E_a = 0.8$

Rainfall data: $P_a = 12.0$ inches $P_e = 8.0$ inches
 $SP_a = 1.0$ inch $E_{os} = 2.0$ inches

Find: Determine the gross irrigation requirement.

Solution: From equation 2-78:

$$P_{net} = P_a - SP_a - E_{os} = 12 - 1 - 2 = 9 \text{ in}$$

Using these data with the iteration procedure for L_r as in the previous examples produces an L_r of 0.16, thus:

$$F_i = \frac{ET_c}{1 - L_r} - P_e = \frac{26}{1 - 0.16} - 9 = 22.0 \text{ in}$$

$$F'_g = \frac{F_i}{(1 - F_{ro})} = \frac{22}{(1 - 0.10)} = 24.4 \text{ in}$$

$$F_g = \frac{(ET_c - P_e)}{E_a} = \frac{(26 - 8)}{0.8} = 22.5 \text{ in}$$

Thus in this case salinity management is the governing factor, and the average annual gross irrigation requirement is 24.4 inches.

Example 2-31 calculates the results of a surface irrigation system that has an irrigation efficiency of 60 percent and surface runoff of 20 percent.

Example 2-31 Seasonal irrigation requirement for a surface system

Given: The same data as that for the arid area gross irrigation example (example 2-30), except:
Application efficiency = 60%
Surface runoff = 20%

Find: Determine the gross seasonal irrigation requirement.

Solution: The needed leaching requirement is still 0.16 and the gross irrigation would be:

$$F'_g = \frac{22}{(1-0.2)} = 27.5 \text{ in}$$

$$F_g = \frac{18}{0.6} = 30 \text{ in}$$

In this case, the efficiency of the irrigation system indicates a higher gross irrigation requirement than required for salinity control.

(b) System capacity requirements

Along with to meeting the seasonal irrigation requirement, irrigation systems must be able to supply enough water to prevent crop water stress during a shorter time period. The system capacity is the rate of water supply that the irrigation system must provide to prevent water stress. The water supply rate (Q) is often expressed in units of inches per day or gallons per minute per acre (gpm/ac):

$$Qt = F_g A, \text{ so } \frac{Q}{A} = \frac{F_g}{t} \quad [2-107]$$

for common units:

$$\frac{Q, \text{ gpm}}{A, \text{ acres}} = 18.86 \frac{F_g, \text{ inches}}{t, \text{ days}}$$

where:

A = irrigated area

t = time to irrigate the field

The water supply rate can also be expressed as the total volume flow rate for a field by multiplying the capacity in gpm/acre times the area of the field.

The system capacity must account for crop need and the efficiency of the irrigation system. These computations are distinguished by the net system capacity (C_n) versus the gross system capacity (C_g). The net capacity is determined by the supply rate needed to maintain the soil water balance above a specified level that will reduce or minimize water stress. The gross capacity is the combined effect of crop needs and system inefficiency. Net and gross capacity are related by the application efficiency and the percentage downtime (D_t) for the system:

$$C_g = \frac{C_n}{E_a \left(1 - \frac{D_t}{100}\right)} \quad [2-108]$$

where:

C_g = gross system capacity

C_n = net system capacity

E_a = application efficiency, expressed as a decimal

D_t = irrigation system downtime, %

The application efficiency used in equation 2-108 can be estimated for various systems using data from section 623.0209. The downtime is the amount of time the irrigation system is inoperable because of scheduled maintenance, breakdowns, moving or adjusting irrigation equipment, load management programs, and other management considerations. For example, if a system is inoperable 1 day per week, the percentage downtime would be 14 percent.

The capacity described in equation 2-108 does not include onfarm conveyance losses. If the irrigation delivery system for the farm contains major losses, then the capacity needed at the delivery point on the farm should be increased as discussed in 623.0209(e).

The conveyance efficiency (E_c) is used to compute the losses in the delivery system such that the farm capacity (C_f) can be computed:

$$C_f = \frac{C_g}{E_c} \quad [2-109]$$

where:

C_g = gross capacity for each field

E_c = conveyance efficiency

Example 2-32 illustrates the use of equation 2-109.

Pipelines generally have a high conveyance efficiency that can be reliably estimated. The conveyance efficiency of canal delivery systems varies greatly especially for earthen canals. A range of conveyance efficiencies for various delivery systems is given in table 2-53.

Example 2-32 Farm capacity

Given: A farm has an irrigation system with a net capacity of 0.3 inch per day. It has two fields as shown below. Each field is 80 acres and is irrigated with siphon tubes. The application efficiency is 65 percent for both fields. The system is shut down about 10 percent of the time.

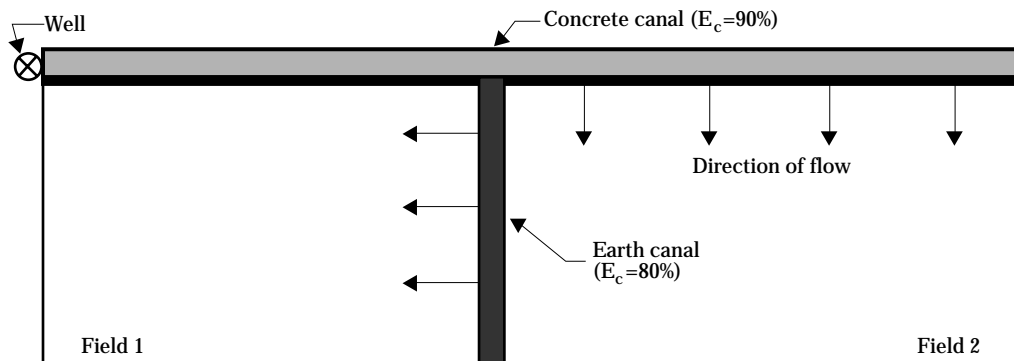

Find: Determine the discharge needed from the well.

Solution: 1. Net capacity for the farm is expressed in inches per day. Use equation 2-107 to convert to flow rate per unit area (gpm/ac):

$$C_n = 0.30 \text{ in / d} \times 18.86 = 5.7 \text{ gpm / acre}$$

2. The gross capacity for each field is (equation 2-108):

$$C_g = \frac{5.7 \text{ gpm / ac}}{0.65 \times (1 - 0.1)} = 9.7 \text{ gpm / ac} \times 80 \text{ ac} = 780 \text{ gpm}$$

3. However, the losses in the conveyance system must also be supplied by the pump. The discharge needed at the turnout into the earth canal for Field 1 should be:

$$C_{f1} = \frac{780 \text{ gpm}}{0.80} = 975 \text{ gpm}$$

The discharge for the concrete canal supplying Field 2 would be:

$$C_{f2} = \frac{780 \text{ gpm}}{0.90} = 867 \text{ gpm}$$

The well must supply the total flow to each field plus the loss in the main supply canal:

$$C_f = \frac{(975 + 867)}{0.90} = 2,047 \text{ gpm}$$

So the well and pump should supply about 2,050 gpm.

(c) Net system capacity

Determining the net system capacity is generally the most difficult process in computing irrigation supply rates. Irrigation systems must supply enough water over prolonged periods to satisfy the difference between evapotranspiration demands and rainfall. Water stored in the crop root zone can supply part of the crop demand. However, the volume of water that can be extracted from the soil cannot exceed the amount that will induce crop water stress.

A careful accounting of the soil water status is required if soil water is used to supply crop water needs when the crop evapotranspiration demands are larger than the irrigation system capacity plus rainfall. Some irrigation designs have been developed to completely meet peak ET_c needs without reliance on either rain or stored soil water. Other design techniques intentionally rely on stored soil water to meet crop requirements. Each method is reviewed in the following subsections.

(1) Peak evapotranspiration methods

The most conservative method of designing irrigation systems is to provide enough capacity to meet the maximum expected or "peak" evapotranspiration rate of the crop. In this case rain and stored soil moisture are not considered in selecting the system capacity. This design procedure relies on determining the distribution of ET_c during the year for the principle irrigation crops. The ET_c during the season varies from year to year (fig. 2-51). For this example, the peak ET_c occurs in late June and early July. The mean ET_c during this period is about 0.16 inch per day. However, the ET_c is higher than 0.16 inch per day half of the time, and an irrigation system should be designed accordingly with a capacity larger than 0.16 inch per day.

The daily ET_c for ryegrass shown in figure 2-51 is less than 0.21 inch per day about 90 percent of the time and less than 0.22 inch per day about 95 percent of the time. In other words, if a system was designed with a net system capacity of 0.22 inch per day, the system could be expected to supply enough water to avoid crop water stress 95 percent of the time, or 19 out of 20 years. Because peak ET_c methods disregard rain and stored soil moisture, the capacity at the 90 percent frequency or probability level would be adequate for design. For the example in figure 2-51, the net system

capacity should be about 0.21 inch per day, or about 4 gpm per acre.

The ET_c frequency distribution shown in figure 2-51 is for daily ET_c . The average ET_c for the period between irrigations decreases as the length of the time between irrigations increases (as explained in section 623.0203, figure 2-14). Using the 90 percent frequency for a field that is irrigated weekly (i.e., 7-day period in fig. 2-14), the average daily ET_c rate would be reduced to 0.19 inches per day, giving a peak capacity of 3.6 gpm per acre. Thus, by designing for the anticipated interval between irrigations, the system capacity could be reduced by about 10 percent. This reduction in capacity can save irrigation development costs, especially for permanent canal based systems.

Designing for peak capacity depends on the ET_c frequency distribution. The ET_c during the peak ET_c time period can be computed using the procedures presented in section 623.0203 of this chapter. Climatic data from at least 10, and preferably more, years should be used to compute the ET_c distribution. The computed ET_c must be analyzed to determine the ET_c rate for the appropriate design probability.

Figure 2-51 Frequency distribution of mean daily ET_c of ryegrass for each month in a coastal California Valley (adapted from Doorenbos and Pruitt 1977)

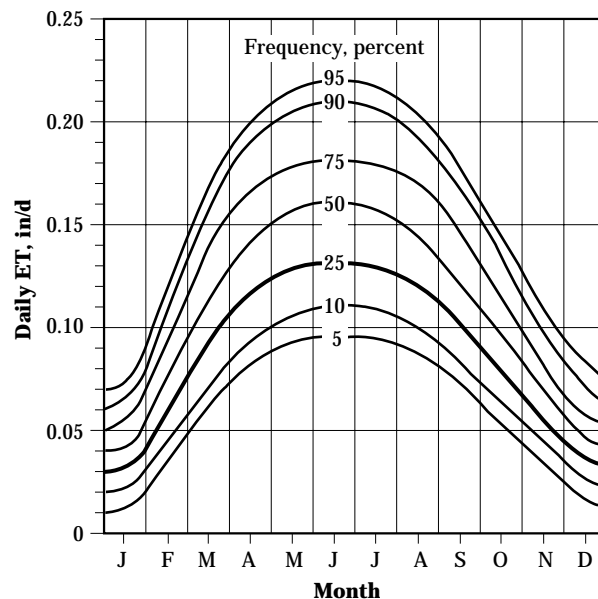

Generally, an extreme value analysis is used with the distribution of the annual maximum ET_c to determine the peak ET_c for design. To use an extreme value analysis, the maximum ET_c for each year is determined. The maximum annual ET_c values are then ranked in ascending order, and the probability of each ET_c value is computed as:

$$P_b = 100 \left(\frac{m}{n+1} \right) \quad [2-110]$$

where:

- P_b = probability that the ET_c will be less than a specified value
- m = rank of an ET_c value ($m=1$ for the smallest ET_c data value)
- n = number of years analyzed.

Example 2-33 illustrates the process.

Once the probability has been computed, the data can be plotted and a smoothing procedure used to better extrapolate the data to the design value. The annual extreme ET_c data generally requires a specialized frequency distribution to represent the data. Two distributions that commonly fit these types of data are the log-normal distribution and the Weibull distribution.

The *log-normal distribution* assumes that the logarithm of the maximum daily ET_c values is normally distributed. The log-normal distribution is a bounded distribution for $ET_c \geq 0$ and is skewed to the left of the mean ET_c . It can be analyzed using special graph paper where the ET_c data is plotted directly. If the data fit a log-normal distribution, it generally falls on a straight line on the special graph paper. The straight line can then be used to predict the design peak ET_c rate.

The probability data from the example 2-33 for maximum daily ET_c are graphed on the log-normal plot shown in figure 2-52. The best fitting straight line is used to determine the design peak ET_c rate for the selected probabilities. Typical design probabilities are 75, 80, 90, or 95 percent depending on the value of the intended crop.

For the data in figure 2-52, the design peak ET_c rates would be:

Design probability	Peak ET_c (in/d)
75	0.45
80	0.46
90	0.51
95	0.55

The *Weibull distribution* can also be used to analyze the extreme ET_c . This procedure is well described by James (1988). The probability of ET_c being smaller than a specified value is computed using the procedure described for equation 2-110. Then the Weibull transform of P_b is computed:

$$W = \text{LOG} \left[-\text{LOG} \left(\frac{P_b}{100} \right) \right] \quad [2-111]$$

where:

- W = the Weibull transform of P_b
- P_b = probability ranging from 0 to 100
- LOG = the base 10 logarithm

The Weibull transform of P_b is then plotted on regular graph paper, and the design peak ET_c rate is determined. The use of the Weibull method for the example data from James (1988) is illustrated in example 2-34.

Example 2-33 Peak evapotranspiration frequency analysis

Given: Assume crop coefficient (K_c) = 1.0 for this period. Pan coefficient (K_p) = 0.75.

Daily evaporation from a Class A evaporation pan, in/d

Day	Year									
	1	2	3	4	5	6	7	8	9	10
1	0.64	0.32	0.24	0.30	0.15	0.22	0.28	0.35	0.23	0.27
2	0.25	0.41	0.26	0.17	0.31	0.42	0.18	0.42	0.65	0.28
3	0.35	0.30	0.17	0.25	0.52	0.15	0.32	0.23	0.22	0.27
4	0.31	0.10	0.39	0.16	0.16	0.45	0.31	0.42	0.60	0.26
5	0.20	0.14	0.29	0.30	0.42	0.45	0.33	0.43	0.39	0.54
6	0.49	0.36	0.36	0.60	0.39	0.30	0.38	0.22	0.55	0.39
7	0.38	0.35	0.33	0.23	0.22	0.49	0.36	0.36	0.68	0.43
8	0.27	0.36	0.11	0.36	0.21	0.30	0.41	0.21	0.23	0.42
9	0.61	0.45	0.23	0.35	0.22	0.45	0.26	0.26	0.23	0.43
10	0.55	0.47	0.40	0.43	0.06	0.52	0.45	0.35	0.30	0.30

Find: Determine the peak ET_c rate for design.

Solution: Example calculation for day 1 of year 1:

$$ET_o = K_p E_{pan} = 0.75 \times 0.64 \text{ in/d} = 0.48 \text{ in/d}$$

$$ET_c = K_c ET_o = 1.0 \times 0.48 \text{ in/d} = 0.48 \text{ in/d}$$

The resulting daily ET_c for the crop is:

Daily crop evapotranspiration, in/d

Day	Year									
	1	2	3	4	5	6	7	8	9	10
1	0.48	0.24	0.18	0.23	0.11	0.17	0.21	0.26	0.17	0.20
2	0.19	0.31	0.20	0.13	0.23	0.32	0.14	0.32	0.49	0.21
3	0.26	0.23	0.13	0.19	0.39	0.11	0.24	0.17	0.17	0.20
4	0.23	0.08	0.29	0.12	0.21	0.34	0.23	0.32	0.45	0.20
5	0.15	0.11	0.22	0.23	0.31	0.34	0.25	0.32	0.29	0.41
6	0.37	0.27	0.27	0.45	0.29	0.23	0.29	0.17	0.41	0.29
7	0.29	0.26	0.25	0.17	0.17	0.37	0.27	0.27	0.51	0.32
8	0.20	0.27	0.08	0.27	0.16	0.23	0.31	0.16	0.17	0.32
9	0.46	0.34	0.17	0.26	0.17	0.34	0.20	0.20	0.23	0.23
10	0.41	0.35	0.30	0.32	0.05	0.39	0.34	0.26	0.23	0.23
An. max.	0.48	0.35	0.29	0.45	0.39	0.39	0.34	0.32	0.51	0.41

Ranking of annual maximum values (m)

	1	2	3	4	5	6	7	8	9	10
Annual maximums (in/d)	0.29	0.32	0.34	0.35	0.39	0.39	0.41	0.45	0.48	0.51
P_b	9.1	18.2	27.3	36.4	45.5	54.5	63.6	72.7	81.8	90.9

Example 2-34 Weibull distribution

Given: The maximum annual ET_c or net irrigation requirement from James (1988) is listed in the table below.

Find: The design net irrigation requirement for design probabilities of 75, 80, 90, and 95 percent

Solution: The procedure to solve the problem is:

- 1) The net irrigation requirement data is ranked in ascending order.
- 2) The probability of a smaller ET_c than a specified value is calculated using equation 2-110.
- 3) Compute the Weibull transform (W) using equation 2-111.
- 4) Plot W versus the net irrigation requirement.
- 5) Determine the probable maximum ET_c from the best fitting straight line.

Maximum annual irrigation requirement (in/d)	Rank	P_b	W	Maximum annual irrigation requirement (in/d)	Rank	P_b	W
0.280	1	4.3	0.13	0.358	12	52.2	-0.55
0.291	2	8.7	0.03	0.358	13	56.5	-0.61
0.311	3	13.0	-0.05	0.370	14	60.9	-0.67
0.319	4	17.4	-0.12	0.382	15	65.2	-0.73
0.331	5	21.7	-0.18	0.382	16	69.6	-0.80
0.331	6	26.1	-0.23	0.382	17	73.9	-0.88
0.339	7	30.4	-0.29	0.390	18	78.3	-0.97
0.350	8	34.8	-0.34	0.390	19	82.6	-1.08
0.350	9	39.1	-0.39	0.402	20	87.0	-1.22
0.350	10	43.5	-0.44	0.402	21	91.3	-1.40
0.358	11	47.8	-0.49	0.429	22	95.7	-1.71

Sample data from James (1988).

Results of the analysis are listed in the following table and are plotted in figure 2-53. Based on the analysis the design probabilities are:

Probability	Design net irrigation requirement, (in/d)
75	0.38
80	0.39
90	0.41
95	0.44

Figure 2-52 Log-normal probability distribution to smooth extreme values for daily ET_c data (values plotted are the daily maximum data and the maximum 5-day average)

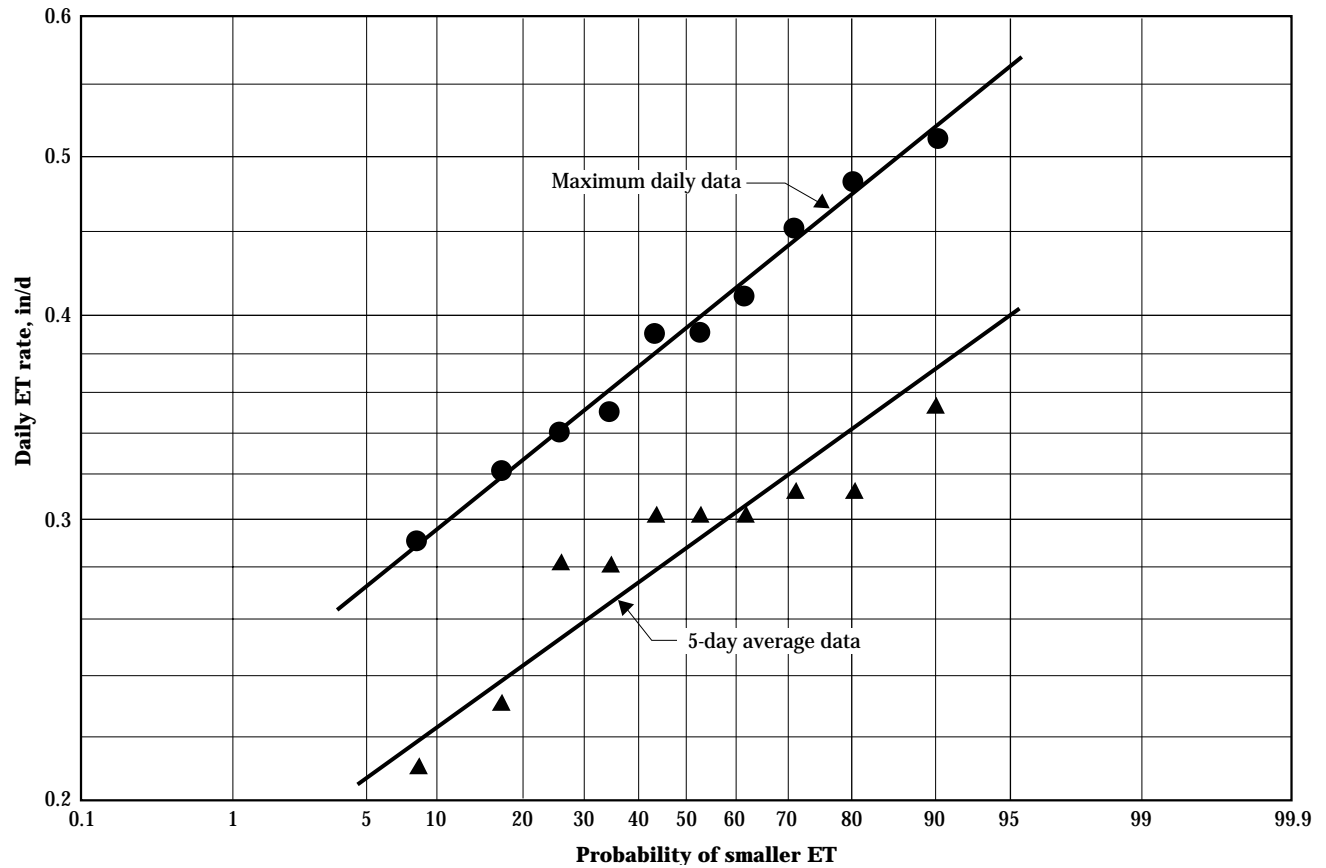
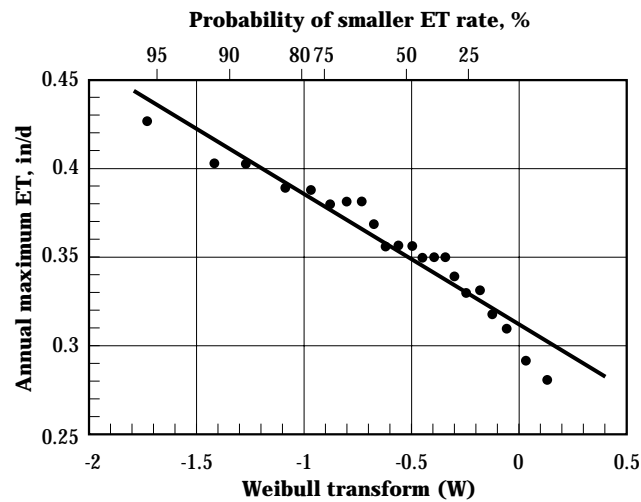

Figure 2-53 Weibull transform for smoothing annual maximum ET_c data to predict the design net capacity required



The data for daily maximum ET_c from the log-normal frequency analysis resulted in a relatively large design ET_c . If a field is irrigated less often than daily, the average ET_c for the appropriate period can be used in the frequency analysis. To illustrate this effect, the average daily ET_c for the first and last 5-day period for the 10 years of data used for the log-normal example are listed in table 2-54. The maximum 5-day average daily ET_c for each year is also shown.

The frequency analysis of the 5-day ET_c data is shown in figure 2-52. At a 90 percent probability level, the design ET_c rate drops from 0.51 inches per day for the daily maximum data to 0.36 inches per day for the 5-day average data. The examples shown in figure 2-52 were developed from a very limited amount of data. Actual analysis would require much more data. However, the examples show the dependence of the peak design ET_c rate on the length of the time period and illustrate the analysis procedure. The Weibull analysis could also be applied to maximum ET_c data for a given period or daily data.

Sometimes it is not possible to obtain enough climatic data to perform a frequency analysis of irrigation requirements. Doorenbos and Pruitt (1977) present a method (fig. 2-54) to predict the monthly peak ET_c from the mean monthly ET_c and the nominal irrigation depth for a probability level of 75 percent. In other words, the crop ET_c can be expected to be less than the determined value 3 out of 4 years. The use of Doorenbos and Pruitt (1977) method is illustrated in example 2-35.

Example 2-35 Peak evapotranspiration

Given: Mean monthly evapotranspiration for corn = 0.30 in/d
Semi-arid climate
Normal depth of irrigation = 2.2 in.

Find: The mean ET_c rate for the peak month

Solution: From figure 2-54, ratio of peak/mean monthly ET_c is 1.1
Then the peak $ET_c = 1.1 \times 0.30$ in/d
 $= 0.33$ in/d

A method to predict the daily peak period ET_c rate for general conditions is shown in table 2-55 (USDA-SCS 1970). This relationship should only be used for general estimates and where the previous peak ET_c methods cannot be applied.

(2) Soil water balance methods

The previous system capacity methods are based on selecting a system capacity that can supply water at a rate equal to the peak ET_c for a period. However, it is unlikely that several periods with water requirements equal to the peak ET_c will occur consecutively. The crop water use during the combined time period can come from the irrigation supply or from rain and stored soil water. Therefore, the capacity could be reduced if rain is likely or if stored soil water can contribute part of the ET_c demand.

Relying on soil water can reduce capacity requirements in two ways. First, the soil moisture can supply water for short periods when climatic demands exceed the capacity. The soil water used during the short period can be stored before it is needed or be replaced to some extent during the subsequent period when the ET_c demand decreases. Where the irrigation capacity is less than the peak ET_c rate, periods of shortage will occur when crop water use must come from the soil or rain (fig. 2-55). However, during other periods the capacity may exceed the ET_c , and the water supplied during the surplus period can replenish some of the depleted soil water.

Table 2-54 Average 5-day ET_c data for the log-normal frequency analysis data

Year	Average daily ET_c for days 1-5 (in/d)	6-10 (in/d)	Maximum annual 5-day ET_c rate, (in/d)
1	0.26	0.35	0.35
2	0.19	0.30	0.30
3	0.20	0.21	0.21
4	0.18	0.30	0.30
5	0.23	0.17	0.23
6	0.25	0.31	0.31
7	0.21	0.28	0.28
8	0.28	0.21	0.28
9	0.31	0.30	0.31
10	0.24	0.30	0.30

Figure 2-54 Ratio of mean peak and mean monthly ET_c for different climates during months of peak water use (adapted from Doorenbos and Pruitt 1977)

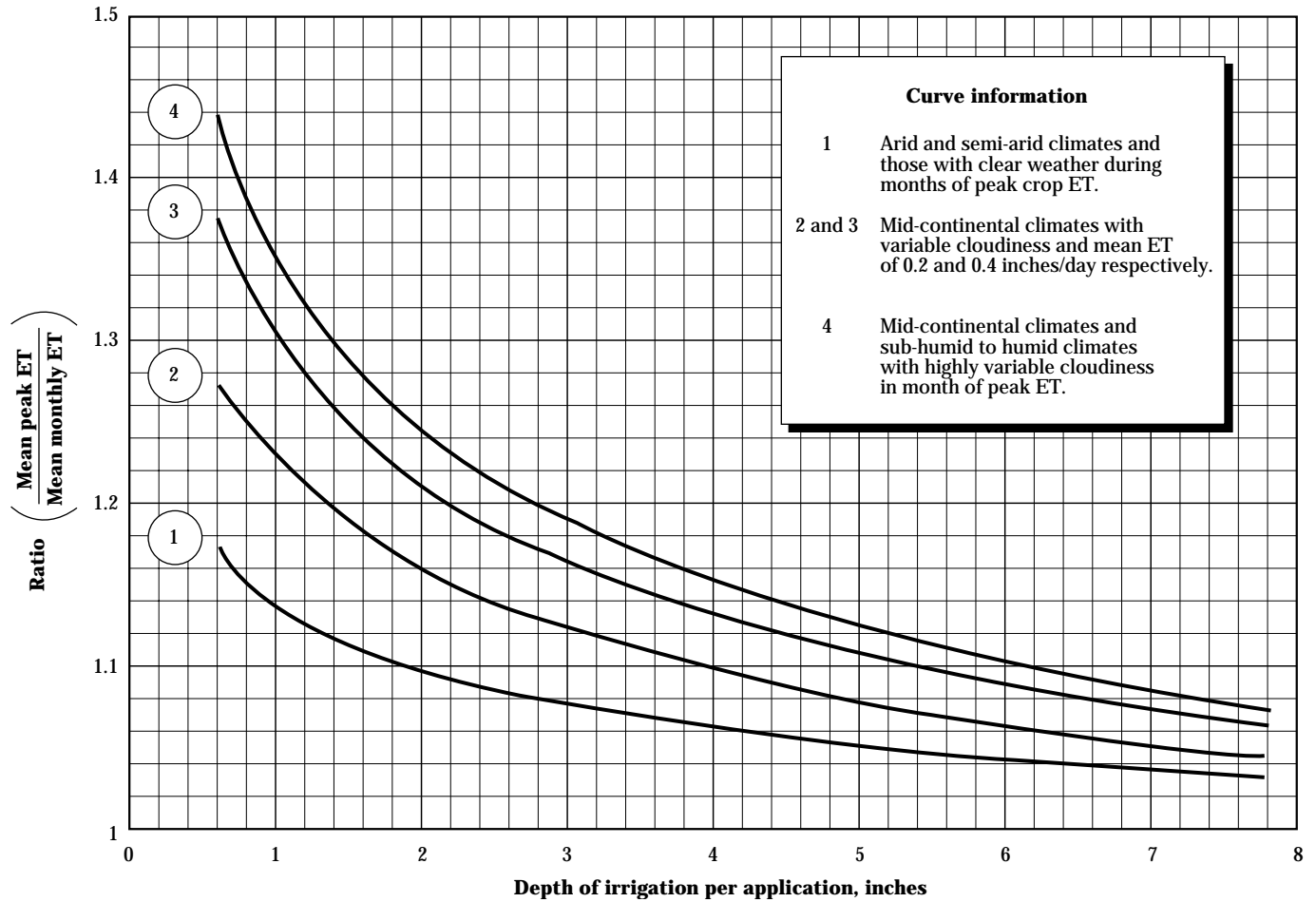
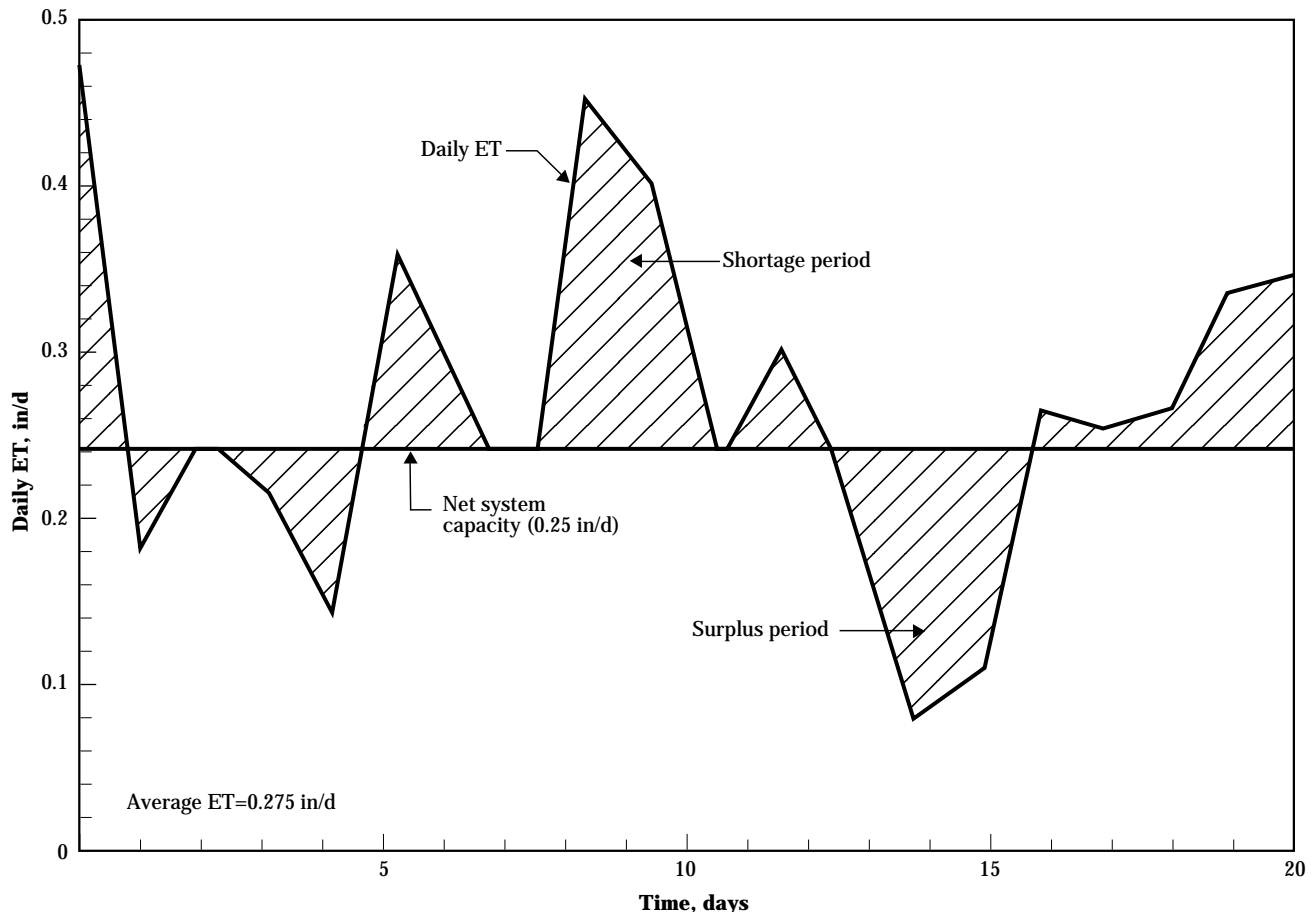

Figure 2-55 Shortage and surplus periods for a system where the capacity is less than the average ET_c during a peak water use period



The second way soil water can contribute to reduced capacity requirements is through a management allowable soil water depletion (MAD). This is the amount of water than can be depleted from the soil before crop stress occurs. The minimum capacity that maintains soil water above the allowable depletion during critical periods of the season can be used to design the irrigation system. An example of the effect of net capacity on soil water mining and the magnitude of soil water depletion during the season is shown in figure 2-56.

The positive bars in figure 2-56 represent the amount of rainfall and ET_c during 10-day periods. After mid-May ET_c exceeds rain. The deficit bars represent the difference between ET_c and rain. The largest 10-day deficit occurs in mid-July. If the use of soil water is not considered, the irrigation system would have to supply the deficit in that period. The peak 10-day irrigation requirement would be 3.3 inches per 10-days (or 6.24 gpm/acre). For the 130-acre field shown in figure 2-56, the net capacity requirement for the peak 10-day period would be 810 gpm. Using an 85 percent application efficiency, the gross capacity requirement would be about 950 gpm.

The amount of water that a 500 gpm capacity system with an 85 percent application efficiency can supply is

also shown in figure 2-56. The net capacity for this system is:

$$C_n (\text{in / day}) = \left[\frac{\left(\frac{500 \text{gpm}}{130 \text{ac}} \right)}{18.86} \right] \times \frac{85}{100} = 0.17 \text{ in / day}$$

The 500 gpm capacity falls short of meeting the deficit in late June, and soil water stored would be depleted. The 500 gpm capacity falls short of the 10-day deficit from early in July through late in August, resulting in a cumulative depletion of 4 inches.

Suppose that the MAD before stress occurs is 3 inches for the crop and soil in figure 2-56. With the 500 gpm capacity system, the soil water would be depleted below the allowable level late in July, and the crop would suffer severe yield reduction. Obviously 500 gpm is inadequate for maximum yield at this site.

The net supply capacity for a 700 gpm system is also shown in figure 2-56. Here the system can supply the 10-day deficit for only the first 10 days in July. The cumulative soil water deficit for the 700 gpm system would be about 1.25 inches with proper management. That depletion is well above the MAD and should not reduce crop yield.

Table 2-55 Peak period average daily consumptive use (ET_d) as related to estimated actual monthly use (ET_m) (USDA 1970)

Net irrigation application F_n (in)	Computed peak monthly crop evapotranspiration rate ET_m (in) ^{1/}																
	4.0	4.5	5.0	5.5	6.0	6.5	7.0	7.5	8.0	8.5	9.0	9.5	10.0	10.5	11.0	11.5	12.0
1.0	.15	.18	.20	.22	.24	.26	.28	.31	.33	.35	.37	.40	.42	.44	.46	.49	.51
1.5	.15	.17	.19	.21	.23	.25	.27	.29	.32	.34	.36	.38	.41	.43	.45	.47	.50
2.0	.15	.16	.18	.20	.23	.25	.27	.29	.31	.33	.35	.37	.39	.41	.44	.46	.48
2.5	.14	.16	.18	.20	.22	.24	.26	.28	.30	.32	.34	.36	.39	.41	.43	.45	.47
3.0	.14	.16	.18	.20	.22	.24	.26	.28	.30	.32	.34	.36	.38	.40	.42	.44	.46
3.5	.14	.16	.18	.19	.21	.23	.25	.27	.29	.31	.33	.35	.37	.39	.41	.44	.46
4.0	.14	.15	.17	.19	.21	.23	.25	.27	.29	.31	.33	.35	.37	.39	.41	.43	.45
4.5	.14	.15	.17	.19	.21	.23	.25	.27	.29	.31	.33	.35	.37	.39	.41	.43	.45
5.0	.13	.15	.17	.19	.21	.23	.25	.26	.28	.30	.32	.34	.36	.38	.40	.42	.44
5.5	.13	.15	.17	.19	.21	.22	.24	.26	.28	.30	.32	.34	.36	.38	.40	.42	.44
6.0	.13	.15	.17	.19	.20	.22	.24	.26	.28	.30	.32	.34	.36	.38	.40	.41	.43

1/ Based on the formula $ET_d = 0.034 ET_m^{1.09} F_n^{-0.09}$ (SCS 1970) where:
 ET_d = average daily peak crop evapotranspiration for the period (in)
 ET_m = average crop evapotranspiration for the peak month (in)
 F_n = net irrigation application (in)

Figure 2-56 10-day ET_c , rain and soil water deficit and the soil water depletion pattern over a growing season as affected by gross system capacity (based on 130-acre field and 85 percent application efficiency)

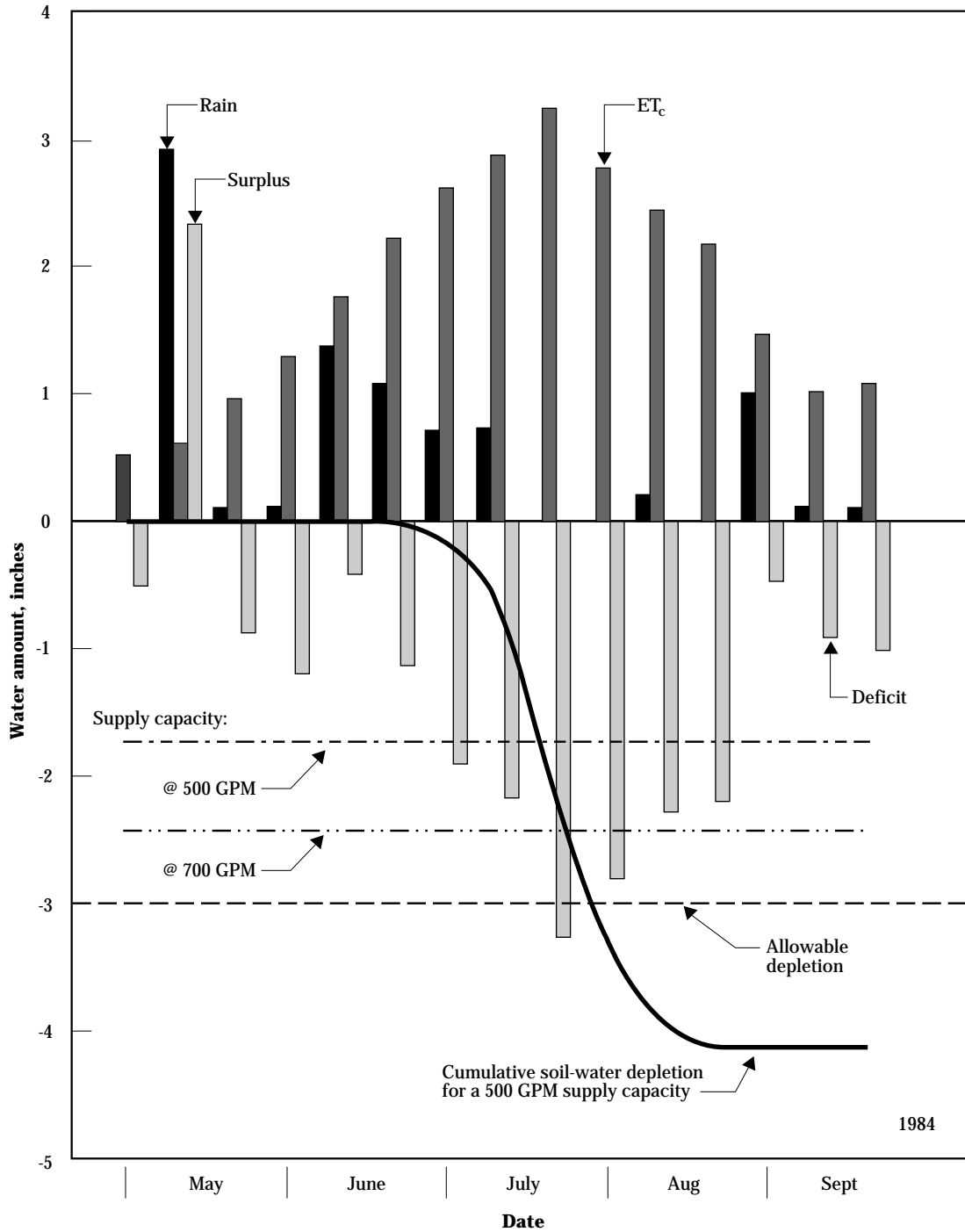

This example shows that the maximum cumulative soil water depletion would be approximately 4, 1.25, and 0 inches for gross capacities of 500, 700, and 950 gpm, respectively. Clearly the opportunity to use available soil water substantially reduces the required system capacity.

Simulation programs using daily time steps to predict the soil water content have been used to determine the net system capacity when soil water is intentionally depleted. Some models, such as those by Heermann, et al. (1974) and Bergsrud, et al. (1982), use the soil water balance equation, such as equation 2-106, to predict daily soil water content. Others used crop simulation models to predict the net capacity to maintain soil water above the specified allowable depletion and the capacity needed to maintain yields above a specified percentage of the maximum crop yield (von Bernuth, et al. 1984 and Howell et al. 1989).

The capacities determined using soil water or crop yield simulation, or both, generally are dependent on the available water holding capacity of the soil. An example from the results of Heermann et al. (1974) is shown in figure 2-57. The allowable depletion of the soil profile must be determined to use the Heermann procedure. The allowable depletion is the product of the allowable percentage depletion and the available water in the crop root zone. The use of Heermann procedure for a sandy loam soil is illustrated in example 2-36.

Example 2-36 System capacity for corn in eastern Colorado

Given: A sandy loam soil that holds 1.5 inches of available water per foot of soil depth. Corn root zone depth of 4 feet. Management Allowable Depletion percentage equals 50 percent

Find: The net system capacity needed at a 95 percent probability level.

Solution: Allowable depletion = $1.5 \text{ in/ft} \times 4 \text{ ft} \times 0.50 = 3.0 \text{ in}$.
From figure 2-57, the net capacity is about 0.22 in/d.

Like peak ET_c methods, net capacity determinations using soil water simulation require analysis of several years of data to define the design probability level. Data from the simulation models have been analyzed in two ways. Heermann, et al. (1974) used a version of an annual extreme value analysis. They kept track of the maximum annual soil moisture depletion for given capacities. Compiling these data for numerous years and analyzing using an appropriate statistical procedure gives the probability that the driest soil condition will be less than the specified allowable depletion.

R.D. von Bernuth, et al. (1984) kept track of the number of days that the soil water depletion exceeded the specified depletion. Combining several years of data provides a data base to develop the probability that the soil water depletion throughout the year will be less than the specified allowable depletion. Thus, the procedures are quite similar; only the probabilities have different meanings.

Figure 2-57 Design net capacity required for corn grown in eastern Colorado to maintain soil water depletion above a specified depletion for three design probabilities (adapted from Heermann, et al. 1974)

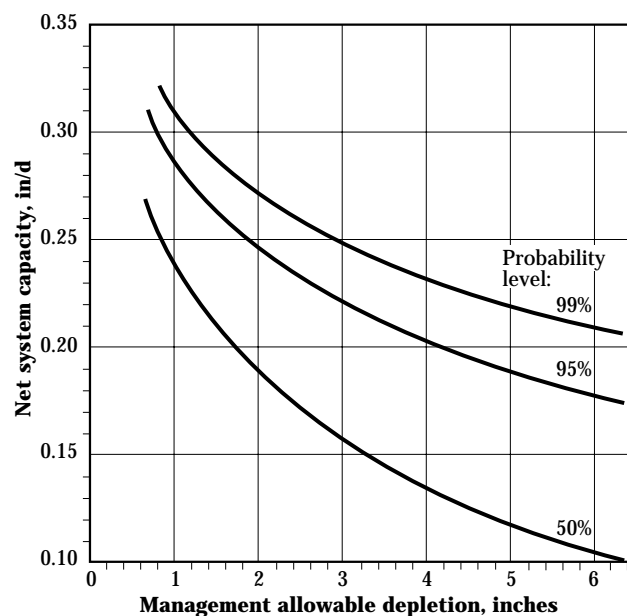

Others showed that the management strategies used to schedule irrigations affects the net capacity requirement (Bergsrud, et al. 1982 and von Bernuth, et al. 1984). If the strategy is to irrigate as soon as the soil will hold the net irrigation without leaching, the capacity will be smaller than if irrigation is delayed until the soil water reaches the allowable depletion. However, there are direct tradeoffs to the reduced system capacity. Delaying irrigation until the allowable depletion is reached results in more efficient use of precipitation and smaller seasonal irrigation requirements.

An example illustrates that the selection of an appropriate system design capacity must consider many factors (Bergsrud, et al. 1982). A well capable of producing 1,200 gpm has been installed. The static water level in the well is 30 feet, and the specific capacity is

30 gpm per foot of drawdown. The quarter section to be irrigated has a predominant soil type with a 4-inch available water holding capacity. A comparison of the two irrigation scheduling strategies is given in table 2-56.

The earliest irrigation date strategy has the advantages of lower initial cost and a lower demand charge on electric installations. The latest irrigation date strategy results in a lower seasonal water application and would appear to have an advantage with respect to electric load management programs because of the fewer hours of operation. The earliest date strategy also has an advantage in low-pressure applications because of lower system capacity and smaller application rates.

Table 2-56 Comparison of the effect of an earliest date and latest date irrigation strategy on system capacity and other performance criteria (adapted from Bergsrud et al. 1982)

	Earliest date	Latest date
Design capacity 90% level	0.226 in/d	0.266 in/d
System capacity 85% application efficiency—0% downtime	652 gpm	768 gpm
Total dynamic head 50 psi pivot pressure	182.2 ft	186.1 ft
Water horsepower	30.0	36.1
Brake horsepower @ 75% pump efficiency	40	48.1
Inches to be applied:		
Net	11.8	9.6
Gross	13.8	11.3
Hours of operation	1,238	861
Brake horsepower hours	49,520	41,414

(d) Irrigation scheduling

An important use of on-farm irrigation requirements is for irrigation scheduling. Irrigation scheduling is deciding when to irrigate and how much water to apply. Modern scheduling is based on the soil water balance for one or more points in the field. By estimating the future soil water content, irrigation can be applied before crop stress and after leaching would occur. Scheduling must involve forecasting to anticipate future water needs.

Several scheduling techniques and levels of sophistication can be applied to keep track of the amount of water in the crop root zone. A widely used method accounts for soil water similar to accounting for money in a checking account. The "checkbook" method depends on recording the soil water balance throughout the season. An example soil water balance sheet is shown in figure 2-58.

The date for future irrigations can be predicted if the average weekly water use rate is known. An example of average water use rates for three crops is shown in figure 2-59.

In some locations crop water use information is made available via newspapers, radio broadcasts, or telephone call-in systems. Any scheduling program should use rainfall measured at the field site. Rainfall amounts measured at the farmstead or in town are not good enough for scheduling because the spatial variability for rainfall is quite large. The checkbook method is simple and easily applied, but is tedious when several fields are considered. Also, forecasting can make bookkeeping cumbersome.

Irrigation scheduling can be fine tuned beyond the checkbook method using computers to calculate crop water use, evaluate alternatives, and consider system characteristics. The basic concept of the first developed computerized scheduling (Jensen, et al. 1971) is widely used today.

Most computer programs use a soil water balance, for one or more points in the field, to determine when to irrigate. The initial soil water depletion at the start of an update period must be known from either soil water measurement or previous calculations. Soil water depletion during the update period is calculated

daily using crop evapotranspiration, rainfall, and irrigation. The deficit at the end of the update period provides the predicted status of the soil water depletion. Anticipated depletion for the future is then predicted for the forecast period using the long-term average water use rate. Irrigations are scheduled when available soil water drops below the MAD, which is often assumed to be 50 percent of the available water for the crop root zone.

To include an irrigation in the soil water balance, the net depth must be determined. The net depth depends upon the type of system. Usually sprinkler systems are operated to apply a known gross depth. Thus, the net depth is the product of the application efficiency and the gross depth.

Surface systems are often operated to refill the crop root zone, or that amount minus some rainfall allowance. The rainfall allowance, room for rain, is generally from 0.5 to 1.0 inches for fine textured soils and is generally not used for sandy soils. For surface systems, the net depth is often known and the gross depth is calculated using the net depth and an application efficiency.

Time required to apply the gross irrigation must be calculated to ensure that the entire field will be irrigated before stress occurs. This is often referred to as the cycle time or the irrigation frequency. This is the time required to apply the gross depth to the entire field with the given system capacity. For example, with a center pivot system, the starting position (fig. 2-60) is the location closest to the usual parking location of the pivot, or the first part to be irrigated. The starting position receives irrigation about 3 days before the last location irrigated (i.e., the stop position). The depletion at the stopping position can be greater than that for the starting position for a good part of the time as shown for a hypothetical period in figure 2-60.

For center pivots and other systems where the field can be irrigated frequently, separate soil water balances are kept for the starting and stopping positions. Combining the time required to irrigate the field and the forecasted depletion at the two positions allows computation of dates for starting irrigation to avoid stress or leaching. This range is described by the earliest and the latest irrigation dates.

Figure 2-59 Average daily water use during the season for three crops in North Dakota (adapted from Lundstrom and Stegman 1988)**Average daily water use for corn (in/d)**

Maximum air temperature, °F	week																
	1	2	3	4	5	6	7	8	9	10	11	12	13	14	15	16	17
50-59	0.01	0.02	0.03	0.04	0.05	0.06	0.07	0.08	0.08	0.08	0.08	0.08	0.07	0.07	0.06	0.04	0.03
60-69	0.02	0.03	0.05	0.06	0.08	0.10	0.12	0.14	0.14	0.13	0.13	0.13	0.12	0.11	0.09	0.07	0.06
70-79	0.03	0.04	0.06	0.09	0.12	0.14	0.17	0.19	0.19	0.19	0.18	0.18	0.17	0.16	0.13	0.10	0.08
80-89	0.04	0.06	0.08	0.11	0.15	0.19	0.22	0.24	0.25	0.24	0.23	0.23	0.21	0.20	0.17	0.16	0.10
90-99	0.05	0.07	0.10	0.14	0.18	0.23	0.27	0.30	0.30	0.29	0.29	0.29	0.26	0.25	0.20	0.16	0.12
Growth stage	3 leaf			12 leaf			tassel	silk	polli- nate	blist. kernel	early dent	dent		mature			

Average daily water use for wheat (in/d)

Maximum air temperature, °F	week													
	1	2	3	4	5	6	7	8	9	10	11	12	13	14
50-59	0.01	0.03	0.04	0.06	0.07	0.08	0.08	0.08	0.08	0.08	0.07	0.06	0.04	0.03
60-69	0.02	0.04	0.07	0.10	0.12	0.13	0.14	0.14	0.14	0.14	0.12	0.10	0.07	0.04
70-79	0.03	0.06	0.10	0.13	0.17	0.19	0.19	0.19	0.19	0.19	0.17	0.14	0.10	0.06
80-89	0.04	0.08	0.12	0.17	0.22	0.24	0.24	0.25	0.25	0.25	0.22	0.17	0.12	0.08
90-99	0.05	0.10	0.15	0.21	0.26	0.29	0.30	0.30	0.30	0.30	0.27	0.21	0.15	0.09
Growth stage	2 tiller		joint	boot	head	flower	early milk	early		hard dough		dough		

Average daily water use for barley (in/d)

Maximum air temperature, °F	week												
	1	2	3	4	5	6	7	8	9	10	11	12	13
50-59	0.02	0.03	0.05	0.06	0.08	0.08	0.08	0.08	0.08	0.07	0.06	0.04	0.02
60-69	0.03	0.05	0.08	0.10	0.13	0.13	0.13	0.14	0.14	0.12	0.09	0.06	0.03
70-79	0.04	0.07	0.11	0.14	0.18	0.18	0.19	0.19	0.19	0.17	0.13	0.08	0.04
80-89	0.05	0.09	0.13	0.19	0.23	0.23	0.24	0.24	0.25	0.22	0.17	0.11	0.05
90-99	0.06	0.10	0.16	0.23	0.28	0.29	0.29	0.30	0.30	0.27	0.20	0.13	0.06
Growth stage	4-5 leaf			head				milk					

Figure 2-60 Irrigation cycle time, or irrigation interval, and its effect on the soil water depletion at the starting and stopping positions of an irrigation system (from Martin et al. 1991)

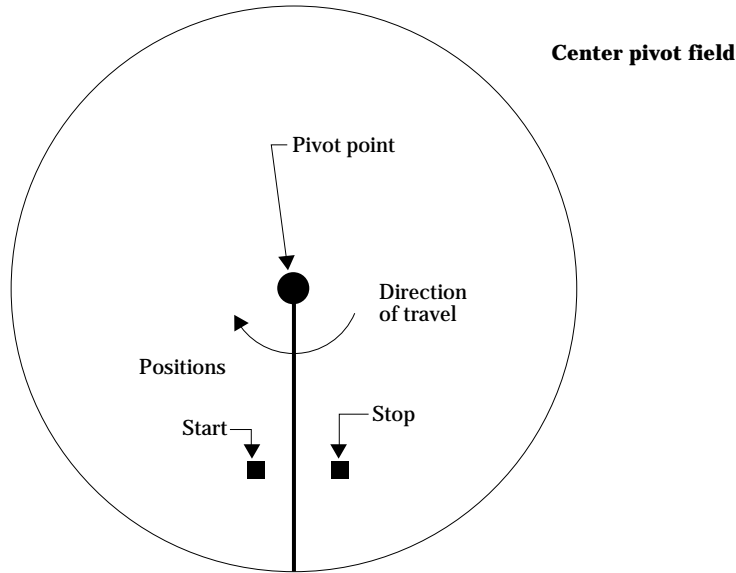

Given:

Cycle time = 3 days
 Area = 130 acres
 Application efficiency = 80%
 Initial soil moisture depletion = 0

System capacity = 1,020 gpm
 Gross depth = 1.25 inches
 Net depth = 1.0 inches

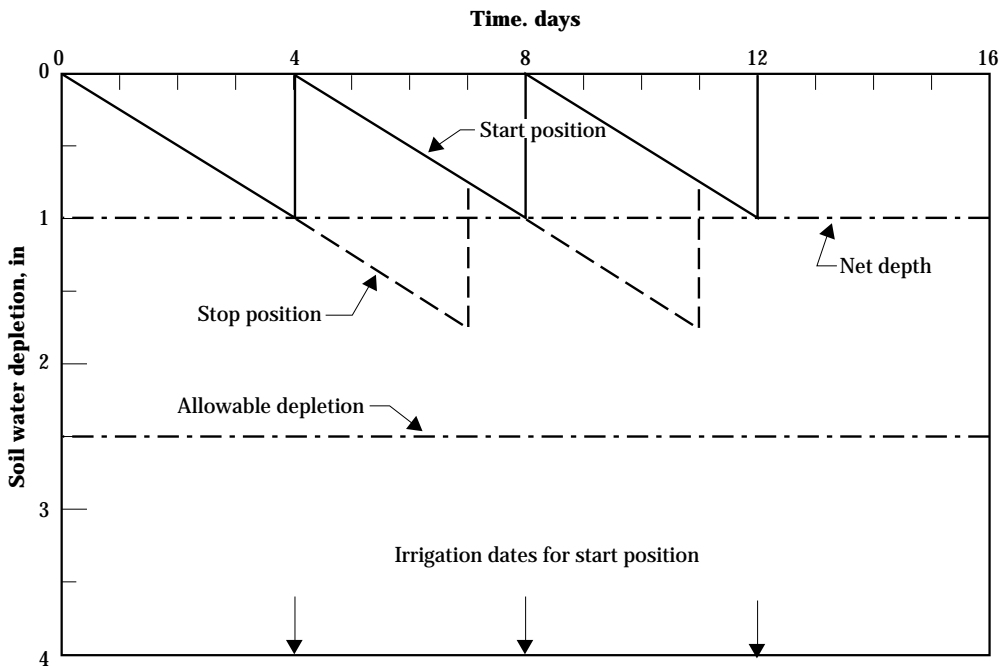

The earliest date corresponds to the earliest time the field will hold the net depth (fig. 2-61). The latest date represents the very latest time to irrigate so that the depletion will not exceed the allowable depletion.

Example 2-37 helps to illustrate the scheduling process and the dependence on crop water use.

Some water management programs are based upon supplying farmers approximate ET_c rates for a region. The individual can then develop a schedule using a checkbook method based upon the regional ET_c rates for the update period, plus forecast ET_c rates. A regional ET_c form is shown in figure 2-62.

The scheduling procedures presented in this chapter are based on the soil water balance because those methods depend on estimating irrigation water requirements. These techniques depend on establishing

an allowable soil water depletion to determine the latest time to irrigate. The allowable depletion depends on the crop, soil, and climate.

Field monitoring techniques can be used to establish the latest time to irrigate. Commonly used methods include measuring soil water potential, leaf water potential, and crop temperature. Each of these techniques must be calibrated for specific applications. Indices have been developed to quantify the effect of various monitoring results. Example indices are the stress day index method by Hiler and Clark (1971), the stress factor from Reddell, et al. (1987), and the crop water stress index by Jackson (1982). The use of these techniques is described by Martin, Stegman, and Fereres (1990).

Figure 2-61 Earliest and latest dates to irrigate for a system that applies 1 inch of net irrigation per application and has an allowable depletion of 3 inches, assuming the irrigation interval is 3 days (adapted from Martin, et al. 1991)

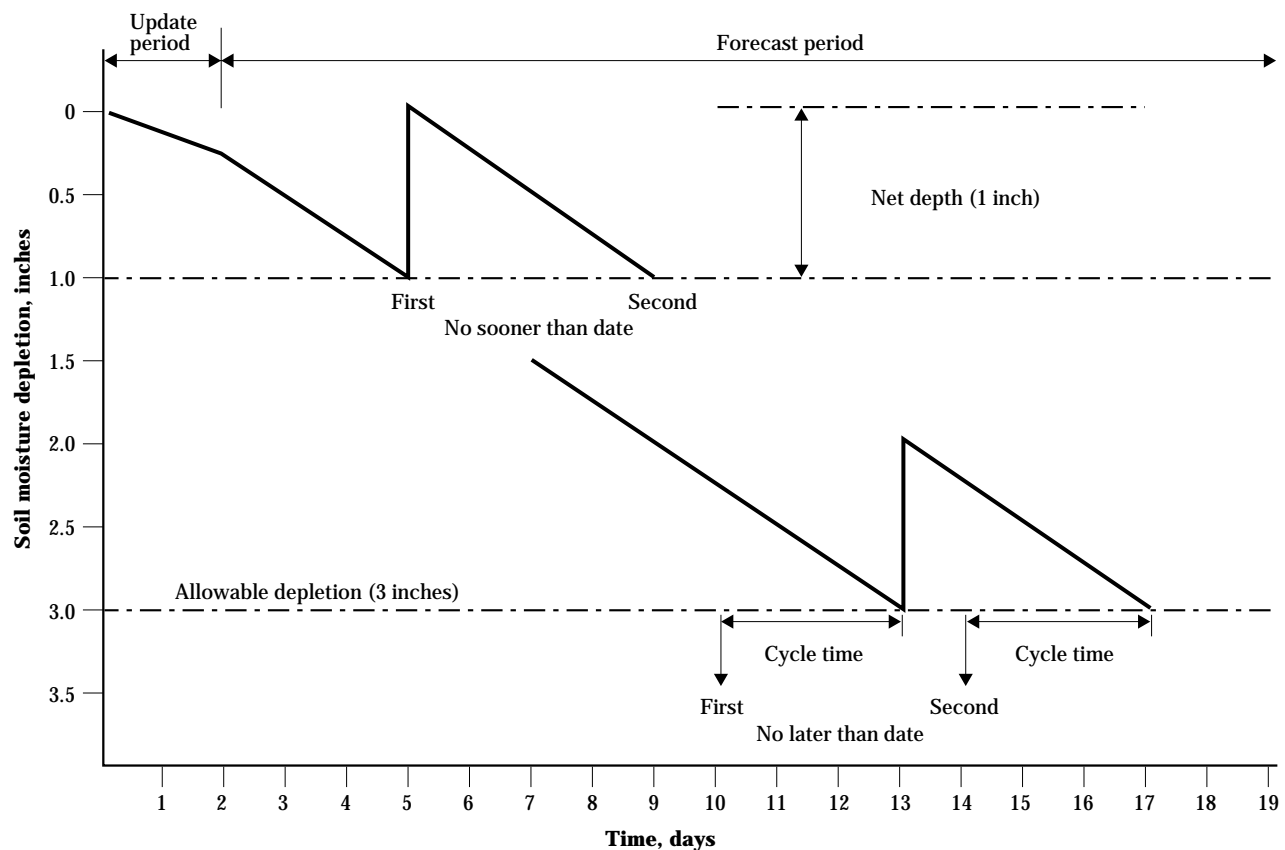

Example 2-37 Irrigation scheduling

Given: Current depletion = 0.5 in. Field area (Area) = 130 acres
 Available water = 1.5 in/ft Normal cycle time (t) = 72 hr
 Current root zone depth = 4 ft Application efficiency = 80%
 Allowable depletion = 50% Forecasted ET_c rate = 0.25 in/d
 System capacity (Q) = 900 gpm

Find: Determine the earliest and latest irrigation dates.

Solution: Gross depth = $Q \times t / (453 \times \text{Area})$ = 1.1 in.
 Net depth = Gross depth \times Application efficiency = 0.9 in.
 Allowable deficit = 1.5 in/ft \times 4 ft \times 0.5 = 3.0 in.

Earliest date	Start position	Stop position
Net depth (in.)	0.9	0.9
less current depletion (in.)	0.5	0.5
Remaining usable water (in.)	0.4	0.4
Forecast ET_c rate (in/d)	0.25	0.25
Days until deficit > net depth	2	2
less cycle time, days	0	3
Earliest date to irrigate	2	-1

Answer: The earliest date is 2 days from now. If the field is irrigated sooner, drainage may occur at the start position. This assumes that the system was originally at the start position.

Latest date:	Start position	Stop position
Allowable deficit (in.)	3.0	3.0
less Current depletion (in.)	0.5	0.5
Remaining usable water (in.)	2.5	2.5
Forecast ET_c rate (in/d)	0.25	0.25
Days until deficit > allowed	10	10
less Cycle time (d)	0	3
Latest date to irrigate	10	7

Answer: The latest date to irrigate is 7 days from now. If the system is started any later, the stop position will become drier than the allowable deficit before the system can reach that point.

This section is a brief review of using crop water use requirements in scheduling irrigation. The methods to predict crop water use similar to those presented in this section are fundamental to modern scheduling.

The practical aspects of scheduling for various purposes are introduced (Martin, et al. 1990). The references cited in this section provide a list of additional reading on using crop water requirements for scheduling and on-farm irrigation management.

Figure 2-62 Example of regional ET_c data for irrigation scheduling

Regional scheduling data

Date	Reference crop ET_c (in/d)	Corn planted May 1 (in/d)	Corn planted May 15 (in/d)	Sorghum planted May 25 (in/d)	Soybean planted May 15 (in/d)	Alfalfa last cut July 1 (in/d)
July 15	0.32	0.29	0.26	0.21	0.22	0.29
July 16	0.28	0.25	0.23	0.18	0.20	0.26
July 17	0.23	0.21	0.19	0.15	0.17	0.22
July 18	0.27	0.25	0.22	0.18	0.20	0.26
July 19	0.15	0.14	0.13	0.10	0.11	0.15
July 20	0.12	0.11	0.10	0.08	0.09	0.11
July 21	0.35	0.24	0.30	0.25	0.27	0.35
July 22	0.42	0.41	0.37	0.30	0.32	0.42
July 23	0.40	0.39	0.35	0.29	0.31	0.40
July 24	0.38	0.38	0.34	0.28	0.30	0.38
July 25	0.31	0.31	0.28	0.23	0.25	0.31
July 26	0.24	0.24	0.22	0.18	0.19	0.24
July 27	0.22	0.22	0.20	0.17	0.18	0.22
July 28	0.35	0.35	0.33	0.27	0.29	0.35
Total	4.04	3.89	3.52	2.87	3.10	3.97

623.0211 Project water requirements

(a) Introduction

Determination of water requirements discussed in previous sections of this chapter have focused on individual fields where the water supply and other conditions did not limit operation of the irrigation system. Where multiple fields must be managed, a delivery schedule for the irrigated area must be developed. In some cases the irrigated area represents all or part of an irrigation project. In others it is a single farm where water delivery must be allocated to individual fields. In both cases a single source of water is available and must be supplied to each parcel of the irrigated area. Various methods have been employed to accomplish this distribution. The irrigation requirements of the crops are, of course, central to that consideration. It is assumed that the water supply is adequate to produce the desired crop yield. Allocation of a deficit water supply to competing fields or irrigators is beyond the scope of this section.

Concepts developed in this part of chapter 2 are provided to explain and illustrate the use of irrigation water requirement information in designing and managing irrigation projects. This is not a design guide for irrigation delivery systems. The material presented is an introduction to complex procedures that are often poorly documented. Refer to other appropriate guidelines for more information on project design.

(b) Irrigation project requirements

Irrigation water requirements can be used to design, manage, and upgrade an irrigation project. The project is defined as blocks of irrigated land that are supplied by a network of canals, pipelines, or both, from a single water source. The irrigated block generally involves several farms with multiple fields per farm. The use of irrigation requirements for designing, managing, and upgrading irrigation projects is similar; thus, general examples are provided to illustrate the procedure.

Irrigation projects must distribute the available water supply to irrigators in an equitable and dependable manner. The irrigator and the water supplier must know what to expect. The only beneficial use of the water diverted into the irrigation project is from the onfarm use of the water for crop production. Thus, it is sensible to provide water to maximize the onfarm benefits. However, there are increasing costs for attaining that last gain of benefits. In some cases the cost of water delivery exceeds the incremental benefit of the improved water supply. Thus, a marginal analysis is necessary to design and operate systems economically. Tradeoffs also exist between the convenience of the supplies versus the flexibility of the irrigator. The issues of economics and flexibility must ultimately be considered in irrigation project operations. These issues will be described through examples of various types of delivery schedules and their impact with respect to onfarm and project management.

(1) Types of delivery schedules

Delivery schedules vary from totally rigid to totally flexible. The rigid schedules are most easily managed by the supplier, while the totally flexible schedules generally produce the highest water use efficiency on the farm if the onfarm irrigation system is well managed.

The *continuous supply system* is the simplest delivery schedule. With this system, a constant flow rate is delivered to the farm turn-out. For a totally continuous system, the supply rate is delivered at a starting time during the season and is shut off at the end of the growing season regardless of the onfarm demand. The supplier can easily manage the system because few decisions are needed and communication between the supplier and the irrigator is not necessary. The constant delivery system generally leads to poor onfarm efficiency because water is supplied when it is not needed and is unavailable in enough quantity during peak use periods. The continuous supply system results in the minimum canal and delivery system capacity. The continuous flow rate is generally quite low and is difficult to manage especially for surface irrigation systems.

A *rotational delivery system* is also a rigid schedule. It supplies a constant discharge (flow rate) to a farm for a fixed duration. The farm then does not receive another supply for a period of time called the irrigation interval. This system does not require communication between the supplier and the farmer and can

result in poor onfarm efficiency because of the variability of the irrigation demand during the growing season. A rotational system has an advantage over a continuous delivery system because the supply rate is large enough to manage and generally requires less labor. A rotational system also allows other field operations to occur more easily than continuous delivery. The capacity of the primary delivery system is generally similar to that of the continuous flow system, but the capacity of the system delivering water to the farm turn-out and the onfarm delivery system generally is larger than that for continuous delivery.

A *demand system*, a flexible schedule, is at the other extreme of the delivery schemes. A pure demand system allows users to remove an unregulated amount of water from the delivery system at the irrigator's convenience. The length, frequency, and rate of water delivery are totally at the irrigator's discretion. A demand system requires the irrigator to communicate with the supplier and generally requires a larger delivery capacity, which increases costs, especially close to the farm. The extra cost of a demand delivery system would hopefully be paid for through improved production on-farm or by irrigating more area with the water saved from increased efficiency.

An *arranged delivery system* varies between the rigid and pure demand schedules. With these supply schedules, either the rate, duration, or frequency, or all three, can be arranged. An agreement is reached between the irrigator and the supplier. Although an arranged schedule provides flexibility to the farmer and generally maximizes water use efficiency, it has some potential problems. First, the manager of the project and the irrigator must understand good water management to manage an unsteady supply system. Second, the equality of water distribution is generally in question and may require investment in special monitoring equipment to measure water consumption. This increases project and production costs. With irrigation projects, especially large projects, the delay between the time an irrigator orders water and when it is delivered is substantial. Because of this, the irrigator should schedule irrigations to determine how much and when water is needed. If climatic conditions change, especially if a substantial rain is received over a large area, during the time between water release and delivery, the efficiency will decrease. This is true, however, of all delivery systems.

The type of delivery system is important in design and management of irrigation projects. Examples in this section help to illustrate the use of irrigation requirements in these activities; however, actual design and management are much more involved than illustrated. The many aspects of project design and management were discussed in a symposium sponsored by the Irrigation and Drainage Division of the American Society of Civil Engineers (Zimbelman 1987).

Delivery schedules depend on the delivery system used. The effect of the delivery system on design will be discussed using the procedures described by Clemmens (1987). Clemmens indicated that three factors are important in sizing the delivery system: delivery flow rate, delivery duration, and the peak water requirement or irrigation frequency. In this context, the peak water requirement represents a gross irrigation capacity requirement. Two peak requirements are important. The first is the aggregate peak during the season when considering all crops and fields within an irrigated block or project. The second is the peak water requirement during the season of any crop on a segment of the delivery system.

The average peak is used to size large canals and the upper end of the supply system because there is little likelihood that the entire area will be planted to the crop with the maximum peak capacity requirement. However, at the end of the canal, the maximum capacity may be needed because the high demand crop could be a principal part of the service area. The average application efficiency during the peak use period should be used to compute the water requirement.

Clemmens indicates that many systems are designed assuming a normal flow rate called the "delivery flow rate." The delivery flow rate might vary from 1 to 3.5 cubic feet per second for a graded surface, trickle or sprinkler irrigation system, and as high as 35 cubic feet per second on a large, level-basin system. The delivery flow rate is easy to manage because the supplier and irrigator know the supply rate, which is generally constant.

The area that can be irrigated with the delivery flow rate is:

$$A_t = 448.8 \frac{(Q_t H_r)}{24 W_u} \quad [2-112]$$

where:

- A_t = the irrigated area (acres)
 Q_t = the delivery flow rate (ft³/s)
 H_r = the daily delivery period (hr/d of water delivery)
 W_u = the average peak water use rate (gpm/acre)

A_t is the area that can be irrigated using a continuous water supply or a complete rotation system.

Clemmens (1987) called A_t the rotational area. The rotational area is computed in example 2-38 for a hypothetical project in Colorado.

The area, flow rate, duration, and gross irrigation depth are related by:

$$t_i = \frac{(A_i F_g)}{(23.8 Q)} \quad [2-113]$$

where:

- t_i = the duration of an individual irrigation (days)
 A_i = irrigated area (acres)
 F_g = gross irrigation depth (inches)
 Q = system flow rate (ft³/s)

The gross irrigation depth can be determined by management preference. With trickle and some sprinkler and level basins, the depth of water applied may be less than required to refill the crop root zone. For other systems the depth equals the soil water depletion divided by the application efficiency.

The minimum irrigation depth that will satisfy crop needs occurs for the continuous supply system where water is supplied for the entire time between irrigations. The frequency (f) of an irrigation is the reciprocal of the time interval between irrigations. For example, if a field is irrigated once every 10 days, the

Example 2-38 Continuous delivery system

Given: A project is to irrigate corn in southeast Colorado using a furrow irrigation system that is 80 percent efficient. The soil is a silt loam that has available water holding capacity of 2.0 inches per foot of soil. The root depth during the peak use period is 4 feet, and the management allowable depletion has been determined to be 50 percent. The delivery flow rate is 4.1 cubic feet per second, and water is delivered 24 hours a day.

Find: Compute the rotational area for this system.

Solution: 1. Use figure 2-57 with 95 percent probability to compute the net capacity:
 Allowable depletion = 0.5 x 4 ft x 2 in/ft = 4 inches
 From figure 2-57, the net system capacity needed is 0.21 in/d
 Using equation 2-107 the average peak water use rate is:

$$\begin{aligned} W_u &= 18.86 \times \frac{C_n}{E_a} \\ &= 18.86 \times \frac{0.21 \text{ in / d}}{0.80} \\ &= 5.0 \text{ gpm / ac} \end{aligned}$$

2. Using equation 2-112, the rotational area is then:

$$\begin{aligned} A_t &= \frac{448.8 \times 4.1 \times 24 \text{ hr / d}}{5.0 \text{ gpm / ac} \times 24} \\ &= 370 \text{ ac} \end{aligned}$$

frequency is 0.1 days^{-1} . The irrigation frequency can be computed by:

$$f = \frac{W_u}{(18.86 F_g)} \quad [2-114]$$

where:

f = irrigation frequency (days^{-1})

W_u = average peak water use rate (gpm/acre)

F_g = the gross irrigation depth (inches)

With a continuous supply, the duration equals the reciprocal of the frequency, and small parts of the field are irrigated continuously during the irrigation interval. This system is generally inefficient and requires an excessive amount of labor. The minimum frequency occurs where the gross depth equals the allowable depletion. A smaller frequency, or longer interval, would result in crop water stress between irrigations.

A rotational system was developed to better manage large-scale delivery systems. Using this system, the irrigated area is subdivided and the delivery flow rate is supplied to each subdivision, or irrigated block, for a specified duration once during the irrigation interval. A delivery schedule for a rotational system is illustrated in example 2-39.

Examples 2-38 and 2-39 illustrate that the required capacity for the 370 acre area will be 4.1 cubic feet per second for either the continuous or the rotational delivery system. The difference between the supply strategies comes in the size of the supply system needed to irrigate each 37 acre block. For the continuous system, a tenth of the delivery flow rate ($0.41 \text{ ft}^3/\text{s}$) was supplied. With rotational delivery, each supply system must have enough capacity to carry the delivery flow rate ($4.1 \text{ ft}^3/\text{s}$) for 1 day and then will be dry for 9 days.

Example 2-39 Rotational delivery system

Given: Use the information from the example 2-38 and assume that the project is divided into 10 irrigated blocks of 37 acres each.

Find: The supply capacity for each block and the duration of irrigation.

Solution: 1. With 10 blocks, a frequency of 0.1 days^{-1} could be used, thus each block would be irrigated for a duration of 1 day. The gross irrigation would be determined from equation 2-114 as:

$$F_g = \frac{W_u}{(18.86 \times f)} = \frac{5.0 \text{ gpm} / \text{ac}}{(18.86 \times 0.1 \text{ day}^{-1})}$$

$$F_g = 2.65 \text{ in}$$

Since the allowable depletion is 4 inches for this system, this depth is acceptable.

2. With a duration of 1 day, the flow rate to each block is determined from equation 2-113:

$$Q = \frac{A_i \times F_g}{(23.8 \times t_i)} = \frac{37 \text{ ac} \times 2.65 \text{ in}}{(23.8 \times 1 \text{ day})}$$

$$Q = 4.1 \text{ ft}^3 / \text{s}$$

The needed flow rate is exactly the same as that for continuous supply because no down time or flexibility is designed into the system.

Suppose that a demand system were implemented. If the goal was to supply the water to a block during 1 day (same duration as for the rotational system), the maximum demand would occur where each block ordered the delivery flow rate on the same day. Thus, the supply system to the 370 acre area must be 10 times the capacity of either the continuous or the rotational delivery system. The supply capacity to each block would still need to be 4 cubic feet per second. Obviously, the cost of the demand system would be much higher than that for the continuous system.

Various authors in the proceedings edited by Zimbelman (1987) point out that the effect of a demand schedule is most severe near farm turn-outs and that the impact on major supply canals and pipelines is reduced because it is unlikely that all users on a project will need a full delivery flow rate at the same time. Pure demand systems are rare, especially for surface irrigation projects where the delivery flow rate is large. This type system is difficult for the supplier to manage and generally is expensive to build.

An example of an arranged delivery system would be to require a 2-day duration with a maximum of 5 blocks irrigated at anytime. The irrigator would need to place a water order in advance to allow time for the supplier to provide the supply. The supplier might allow a maximum flow rate of 2 cubic feet per second per block. The irrigator could request any flow rate up to 2 cubic feet per second and could request more than one supply during a 10-day period.

Many other examples could be developed that allow a range of duration, frequency, and flow rate. The supplier and irrigator should be considered in design and cooperate in operation of an arranged system. In some cases suppliers have attempted to schedule irrigations for the district and provide water based on that schedule. Such systems have had limited success because farmers are unwilling to relinquish control of irrigation management.

Arranged delivery schedules generally are more complicated because the probability of various demands is needed to size the system and to manage the system once a project is on-line. Clemmens (1986) showed that the flexibility allowed by arranged schedules causes the capacity needed in an irrigation project to be bigger than that for rotational systems at the farm turn-out level, but that there was less effect upstream.

(2) Sizing delivery systems

Examples 2-38 and 2-39 illustrate the interaction of rate, duration, and frequency and the effect of the type of delivery system on the capacity needed in an irrigation project. The examples are overly simplistic and do not demonstrate the actual procedure used to size delivery systems.

The procedure used by the U.S. Bureau of Reclamation to size delivery systems is illustrated in figure 2-63. The process begins by determining the net irrigation water requirement using the procedures as described in section 623.0210. For a farm, the part of the irrigable area that will be irrigated should be determined. A commonly used value for U.S. Bureau of Reclamation projects is 97 percent. The onfarm irrigation efficiency should be determined using procedures from section 623.0209. The duration for delivery to the farm should then be determined to provide an estimate of the amount of time irrigation water will be provided to the farm turn-out. Finally, water demands for any beneficial uses besides evapotranspiration should be determined. Given this information, the farm delivery requirement is determined. The delivery schedule should include the necessary capacity, duration, and frequency for all farms served by each component of the delivery system.

The U.S. Bureau of Reclamation uses a flexibility factor to account for the type and management of the delivery system. The factor is the ratio of the actual delivery compared to the minimum delivery if the system operated continuously. Thus a flexibility factor of 1.2 provides 20 percent more capacity than would be needed if the canal supplied water continuously. A flexibility factor of 1.2 allows irrigation 83 percent of the time and still meets the peak water requirements. Of course, the larger the flexibility factor, the higher the cost of the project. The flexibility factor generally is more than 1.0 to provide excess capacity so that irrigators can better manage water on the individual farms. Also, it is generally larger when the area served by a delivery system is small. Selection of a flexibility factor is primarily based on judgment of the designer.

The flexibility factor and the farm delivery requirements are used to develop a system capacity curve as shown in figure 2-64. The system capacity curve relates area in a subdivision of the project to the supply needed for that block. For example, suppose a design following procedures in section 623.0210 called

for delivery of 6.9 gpm/acre to the farm. If a flexibility factor of 1.2 is used, the canal capacity would need to be 8.3 gpm/acre. Often the delivery is measured in cubic feet per second. Because $1.0 \text{ ft}^3/\text{s} = 448.8 \text{ gpm}$, 1 cubic foot per second would be adequate to irrigate about 54 acres (i.e., $54 \text{ acres} \times 8.3 \text{ gpm/acre} = 448 \text{ gpm} = 1 \text{ ft}^3/\text{s}$). This ratio is then used as in figure 2-64 for the curve for turnouts and small laterals. If the area served were 10,000 acres, the delivery into the small laterals would need to be:

$$\frac{10,000 \text{ acres}}{54 \text{ acres per ft}^3 / \text{s}} = 185 \text{ ft}^3 / \text{s}$$

After the system capacity curve is determined, the conveyance losses and operational waste can be estimated. Information from similar systems in the same location can be used along with the data pre-

sented in section 623.0209 to develop initial planning estimates of conveyance and operational losses. Estimates for design and operation should be based on the best possible local information. Field investigations must be conducted to ensure that the selected values are appropriate. With the overall conveyance efficiency determined, delivery capacity needed for a section of the project will be known. The design of the project thus begins at the farm and progresses upstream to the water source.

An example solution for sizing a lateral supply canal is summarized in table 2-57 for the system shown in figure 2-65. It is assumed in table 2-57 that an appropriate analysis using procedures through section 623.0210 has been conducted to determine the net system capacity for each crop and the net capacity during the peak use period for the farm. Using these

Figure 2-63 Processes involved in sizing irrigation projects (adapted from Gibbs 1972)

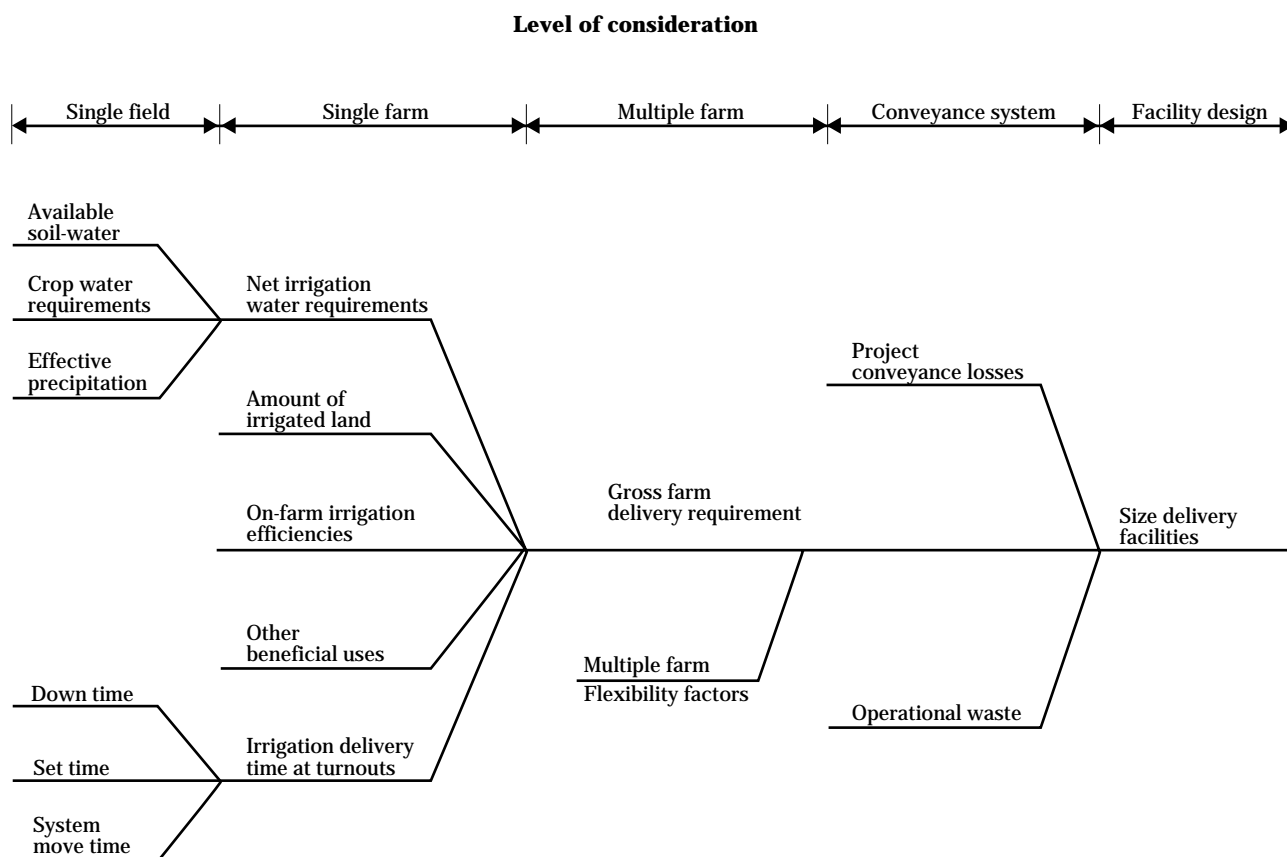

data, the delivery capacity needed for continuous supply at the field is computed using the field application efficiency and the water use rate during the peak period. The continuous delivery flow rate is determined by solving for Q_t in equation 2-112.

The conveyance efficiency for each field is computed as the product of the efficiency of the series of distribution systems that supply each field. For example, with field 1, the field conveyance efficiency is the product of the conveyance efficiency of canals 1 and 2 ($0.9 \times 0.8 = 0.72$, or 72%). If water were supplied continuously to field 1, the capacity would have to be $1.64 \div 0.72 = 2.28 \text{ ft}^3/\text{s}$. Using a flexibility factor of 1.2 would increase the supply capacity needed for field 1 to $2.28 \times 1.2 = 2.73 \text{ ft}^3/\text{s}$.

When the continuous farm delivery requirement is added for all fields, the farm requirement is about $19.5 \text{ ft}^3/\text{s}$. Thus, about 47 acres can be irrigated with $1 \text{ ft}^3/\text{s}$ for this farm. Using the flexibility factor of 1.2 increases the farm requirement to about $23.4 \text{ ft}^3/\text{s}$ and reduces the area per cubic foot per second ratio to 39.3 acres per cubic foot per second.

The capacity of the lateral canal can be determined using the area per cubic foot per second ratio determined for the representative farm. There are 5,000 acres in the irrigated block, and the lateral canal efficiency is expected to be about 90 percent. Therefore, the lateral canal will need a capacity of about $141 \text{ ft}^3/\text{s}$ (i.e., $5,000 \text{ acres} \div 39.3 \text{ acres per ft}^3/\text{s} \div 0.9$).

Figure 2-64 System capacity curve for a conveyance system (adapted from Gibbs 1972)

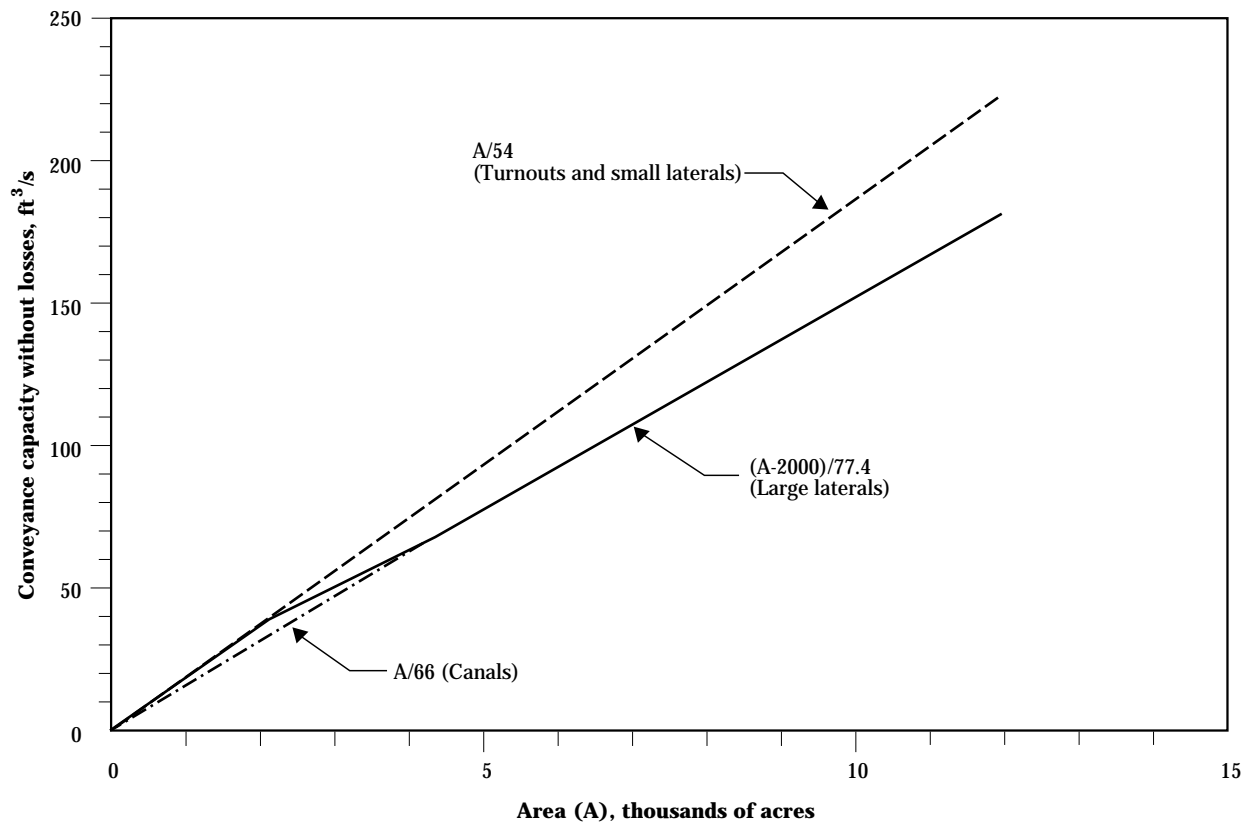

A system capacity curve similar to the one shown in figure 2-64 can be used to determine the capacity needed for similar blocks on a project and is essentially what was done for the sizing example in table 2-57.

(c) Onfarm delivery schedules

Two types of onfarm delivery schedules are necessary for irrigation projects. The first is needed to design the supply system for the farm and will be based on the expected supply needed for individual fields. A well-developed supply schedule provides useful information where the project is new and the irrigator lacks

experience. The initial farm delivery schedule depends on the design flow rate and duration and frequency of irrigation for each field. Other chapters of part 623 of the USDA-SCS National Engineering Handbook discuss design of irrigation systems for specific conditions, thus a detailed example of the design for an individual field will not be included here. It must be emphasized that the individual field design must be compatible with the farm and district supply schedules.

The flow rate frequency and duration of supply must be determined for each field and combined to determine the capacity needed for each supply section. The peak water requirement for a specific field may not

Figure 2-65 Delivery system layout for a farm served by a large lateral canal

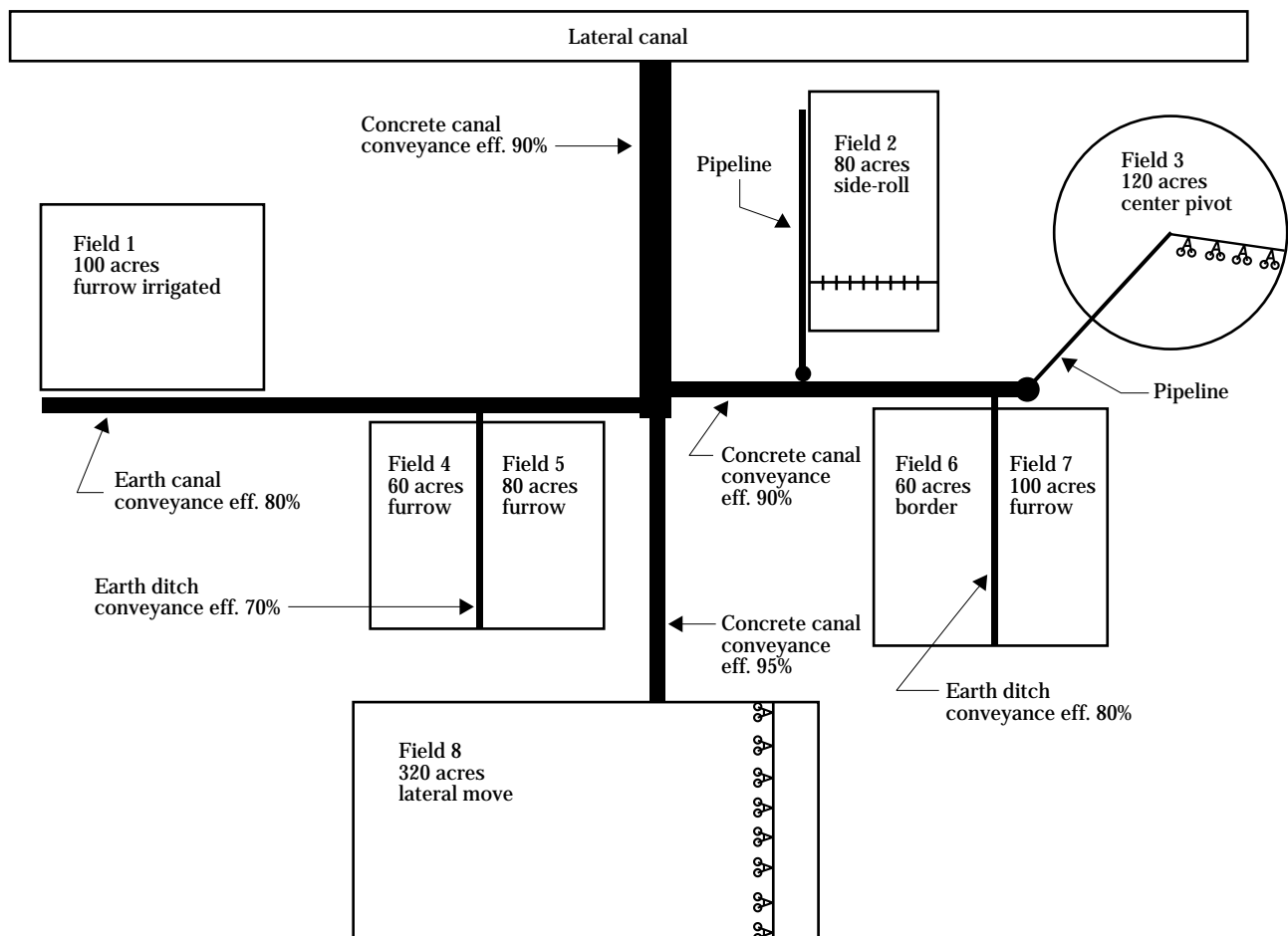

occur at the same time of the season as the farm or project peak. The irrigation requirement for each field along a supply system should be considered throughout the season to select the peak supply capacity of a specific reach of the delivery system.

The farm depicted in figure 2-65 and table 2-57 illustrates several problems that can be encountered when developing delivery schedules for heterogeneous fields. The farm will be difficult to manage for a rotational supply schedule. Sprinkler systems are generally most efficient for small, frequent irrigations, whereas surface irrigation usually requires a larger flow rate and less frequent irrigation. Finding a farm supply schedule to facilitate efficient irrigation on all fields and still fit the project delivery schedule can be quite involved. Auxiliary storage of water on the farm may be necessary if the supply duration to the farm is too short for the sprinkler systems to irrigate the entire field.

The second onfarm supply schedule is the real-time schedule for the farm. The actual conditions on the farm when scheduling irrigation will not be the same as those when the system was designed. The irrigation manager must develop a new onfarm schedule for each irrigation. This is especially critical if water is provided by an arranged delivery system.

Buchleiter and Heermann (1987) detail the use of irrigation scheduling procedures to manage a large, multifield farm. These scheduling functions involve many decisions and constraints that must be considered to develop an effective and feasible schedule. Others have developed routines to provide a water delivery schedule to optimize labor use on the farm (Trava, et al. 1977 and Pleban, et al. 1983). These techniques are beyond the scope of this chapter, but illustrate the use of irrigation water requirements in sophisticated management of modern irrigation systems. Several articles also discuss automation of irrigation projects (Zimbelman 1987). Accurate irrigation water requirement information is the foundation that supports automation.

Table 2-57 Example of canal sizing problem for the system shown in figure 2-65

Field	Crop	Productive area (acres)	Applic. eff. (%)	---- Net system capacity ----			Gross continuous delivery flow rate (ft ³ /s)	Conveyance efficiency field delivery systems (%)	Continuous farm delivery required (ft ³ /s)	Capacity for a 1.2 flexibility factor (ft ³ /s)
				Peak crop (gpm/ac)	Use during month of farm peak (gpm/ac)	(in/d)				
1	Corn	100	75	5.5	5.5	0.29	1.64	72	2.28	2.73
2	Alfalfa	80	80	7.0	7.0	0.37	1.56	90	1.73	2.08
3	Corn	120	80	6.0	6.0	0.32	2.00	90	2.22	2.67
4	Grain sorghum	60	65	5.0	4.5	0.26	0.92	63	1.46	1.75
5	Soybeans	80	65	5.2	4.7	0.28	1.29	63	2.05	2.46
6	Alfalfa	60	75	6.5	6.5	0.34	1.16	72	1.61	1.93
7	Corn	100	70	5.2	5.2	0.28	1.66	72	2.31	2.77
8	Corn	320	85	6.0	6.0	0.32	5.04	86	5.86	7.03
Total		920							19.5	23.4

Farm requirement	= 47.1 acres per ft ³ /s
Flexibility factor	= 1.2
Slope of conveyance capacity curve	= 39.3 acres per ft ³ /s
Area served by lateral canal	= 5,000 acres
Overall conveyance efficiency of lateral	= 90%
Lateral canal capacity needed	= 141 ft ³ /s

(d) Water conservation

Irrigated agriculture consumes the majority of the water used in the western United States. In many areas water shortages are developing, and competition for water is increasing. Some people view water conservation in irrigated agriculture as one means to alleviate competition; however, conservation is poorly understood and difficult to define.

The Council for Agricultural Science and Technology (CAST 1988) used an annual water balance to illustrate the problem of defining conservation. In the annual balance the sources of water are precipitation, applied irrigation water, and stored soil water. Conservation means reducing these amounts of water. The amount of precipitation received cannot be controlled. Likewise, the amount of water in the soil can only be used one time, and over long periods stored soil moisture is a small part of the supply. Thus, the amount of irrigation water, which comes from either ground or surface water supplies, must be reduced to conserve water.

Irrigation water can result in transpiration, evaporation, leaching of salts, deep percolation beyond the leaching requirement, and surface runoff. If less water is applied, then one of the five forms of water use must also decrease. Except for phreatophytes along delivery systems, reductions in transpiration and leaching generally result in less income from crop yield. In many cases the reduction in yield costs more than the water is worth. Conservation in this manner is economically unsound.

Reduction of evaporation through improved application, storage, and conveyance systems may truly conserve water. Methods to cover or shade the soil to absorb radiant energy and to reduce water conduction through the soil can contribute to water conservation. In some systems the savings of evaporation may be small or uncontrollable. Runoff and deep percolation in excess of leaching needs are often viewed as wasteful.

The Council for Agricultural Science and Technology points out that runoff and deep percolation may be lost for an individual farm use, but some of each quantity may return to the water supply by either return flow to a river or as recharge to an aquifer (CAST 1988). Water that returns to the water supply is available to be used again by the same or an alternate

user. However, some runoff and deep percolation accumulate in locations where reuse is impossible or at least economically or environmentally infeasible. Runoff and deep percolation that cannot be reused should be considered a loss that could potentially be conserved.

Conservation of irrigation water raises several political and legal questions, as well. In some cases conservation may not be feasible because those that benefit may not be the ones paying for conservation. For example, an upstream irrigator might be able to improve his system to reduce the amount of water diverted to his farm. That would provide more water downstream for other users; however, the upstream farmer would not benefit. Obviously, the upstream farmer will be hard to persuade to pay for that practice.

Even though water conservation is difficult to define and measure, efforts to use less water for irrigation will more than likely increase. Where conservation is considered, an evaluation of the irrigation project should be made to determine the potential benefits. The procedure developed by Hedlund and Koluvek (1985) is helpful in inventorying potential impacts from building a new project or for renovating an existing project. The summary form for their analysis procedure is shown in figure 2-66. Their procedure has been incorporated into the Farm Irrigation Rating Index by the SCS (USDA 1991).

Water conservation will require that all aspects of irrigated agriculture be evaluated. Alternate cropping and tillage systems and other changes can contribute to water conservation in irrigated agriculture. Methods developed in this chapter are helpful in quantifying water use and conservation potential for some changes. However, several important processes needed to fully describe the effect of differing practices on water conservation are not adequately presented by the methods in this chapter. Future research and developments are needed to completely describe the effect of design and management on the fate of the applied irrigation water.

Figure 2-66 An evaluation form for water conservation inventories of irrigation systems (from Hedlund and Koluvek 1985)

State:	Water district:	Ditch system:			
Watershed:	Irrigated area, acres:	No. of farms:			
Circle the criteria approximating the level; if appropriate					
Factors	Rating low-high	Score	High	Moderate	Low
Water Quantity					
1. Ground water mining	0-5		100%	50%	None
2. Increase farm water supply	0-4		Develop surpluses	Eliminate shortages	No change
3. Reduce diversions	0-4		>50%	10-50%	<10%
4. Reduce return flow	0-3		>50%	10-50%	<10%
5. Improve efficiency					
a. Conveyance	0-2		>30%	10-30%	<10%
b. Onfarm	0-2		>20%	5-20%	<5%
Subtotal	20		Effects:		
Economics					
1. Sustain viable community	0-5		Depressed area significant	Some potential	Viable economy
2. Decrease in cost to produce	0-4		>\$150 gross/acre	some potential	No potential
3. Increase in gross value	0-4			50-100 gross \$/acre	<50 gross \$/acre
4. Increase productivity					
a. Water shortage	0-2		treatable (optimum)	Some yield increase	No potential
b. Soil salinity	0-2		treatable (optimum)	Some yield increase	No potential
c. Water logging	0-2		treatable (optimum)	Some yield increase	No potential
5. Sale of conserved water	0-1		Easily sold >\$100/ac-ft	No sale, but used	No sale, surplus
Subtotal	20		Effects:		
Environmental					
1. Water quality					
a. Salinity	0-2		Treatable (significant)	Some potential	No potential
b. Sediment	0-2		Treatable (significant)	Some potential	No potential
c. Nutrient & pesticides	0-2		Treatable (significant)	Some potential	No potential
2. Wetlands—wildlife	0-2		Few effects	Some change	Lost habitat
3. Instream flow	0-2		Significant improvement	No change	Reduced flow
4. Erosion	0-2		>5 ton/acre reduction	1-5 ton/acre	1 ton/acre
5. Environmental impacts	0-3		None identified	Some	Controversial
Subtotal	15		Effects:		
Social effects					
1. Energy use	0-4		Savings	No change	Increase use
2. Indian lands	0-4		All Indian	Affects Indian	None
3. Loss of prime land	0-4		High value	Low value	No change
4. Impact on existing users	0-2		Change to high value	Some improvement	No impact
5. Life, health, safety	0-1		Reduces hazard	Some improvement	No impact
Subtotal	15		Effects:		
Legal and institutional					
1. Advocate of beneficial use, conservation, salvage	0-4		No conflicts	Neutral	Many problems
2. Ground/surface water laws	0-2		Strong law	Neutral	No laws
3. Loss of water to other users	0-1		No conflict	Neutral	Problems
4. Windfall benefits	0-1		<\$50,000/farmer	Some over \$50,000	Over 100,000
5. New land	0-2		No new land	Very little	>20% new land
Subtotal	10		Effects:		
Implemental Potential					
1. Acceptability					
a. Local	0-4		Active support	Supportable	Opposition
b. State	0-3		Active support	Supportable	Opposition
c. National	0-2		Fits USDA program	Supportable	Requires new
program					
2. Technical assistance	0-2		<4 man-years	4-10 man-years	>10 man-years
3. Capital cost					
a. Conveyance	0-2		<\$250/acre	250-1000 \$/acre	>1000 \$/acre
b. Onfarm	0-3		<\$250/acre	250-800 \$/acre	>800 \$/acre
4. Financial incentives	0-2		<\$1 million	1-10 million	>\$10 million
5. Time to plan and design	0-2		<1 year	1-5 years	>5 years
Subtotal	20		Effects:		
Total	(100 points possible)		Bonus Points:		
Magnitude of problem:					
Viable solutions:					
Additional impacts:					

Appendix A Blaney-Criddle Formula (SCS Technical Release No. 21)

Because of the historical and in some cases legal significance of the Blaney-Criddle equation described in Technical Release No. 21 (SCS 1970), that method is presented in this appendix. The following material is taken directly from Technical Release No. 21. The reference crop methods presented in sections 623.0203 and 623.0204 have proven to be more accurate than this version of the Blaney-Criddle formula. Thus, the reference crop and appropriate crop coefficient techniques are recommended.

Disregarding many influencing factors, consumptive use varies with the temperature, length of day, and available moisture regardless of its source (precipitation, irrigation water, or natural ground water). Multiplying the mean monthly temperature (t) by the possible monthly percentage of daytime hours of the year (p) gives a monthly consumptive-use factor (f). It is assumed that crop consumptive use varies directly with this factor when an ample water supply is available. Expressed mathematically,

$$u = kf$$

$$U = \text{sum of } kf = KF$$

where:

- U = Consumptive use of the crop in inches for the growing season.
- K = Empirical consumptive-use crop coefficient for the growing season. This coefficient varies with the different crops being irrigated.
- F = Sum of the monthly consumptive-use factors for the growing season (sum of the products of mean monthly temperature and monthly percentage of daylight hours of the year).
- u = Monthly consumptive use of the crop in inches.
- k = Empirical consumptive-use crop coefficient for a month (also varies by crops).
- f = Monthly consumptive-use factor (product of mean monthly temperature and monthly percentage of daylight hours of the year).

$$f = \frac{t \times p}{100}$$

where:

- t = Mean monthly air temperature in degrees Fahrenheit.
- p = Monthly percentage of annual daylight hours. Values of p for 0 to 65 degrees north latitude are shown in table 2A-1.

Note: Value of t , p , f , and k can also be made to apply to periods of less than a month.

Following are modifications made in the original formula:

$$k = k_t \times k_c$$

where:

- k = a climatic coefficient which is related to the mean air temperature (t),
- k_t = $.0173t - .314$. Values of k_t for mean air temperatures from 36 to 100 degrees are shown in table 2A-4.
- k_c = A coefficient reflecting the growth stage of the crop. Values are obtained from crop growth stage coefficient curves as shown in figures 2A-1 through 2A-25 at the back of this appendix.

The consumptive-use factor (F) may be computed for areas for which monthly temperature records are available, if the percentage of hours that is shown in table 2A-1 is used. Then the total crop consumptive use (U) is obtained by multiplying F by the empirical consumptive-use crop coefficient (K). This relationship allows the computation of seasonal consumptive use at any location for those crops for which values of K have been experimentally established or can be estimated.

Table 2A-1 Monthly percentage of daytime hours (p) of the year for northern latitudes

Latitude N	Jan	Feb	Mar	Apr	May	Jun	Jul	Aug	Sep	Oct	Nov	Dec
65°	3.52	5.13	7.96	9.97	12.72	14.15	13.59	11.18	8.55	6.53	4.08	2.62
64°	3.81	5.27	8.00	9.92	12.50	13.63	13.26	11.08	8.56	6.63	4.32	3.02
63°	4.07	5.39	8.04	9.86	12.29	13.24	12.97	10.97	8.56	6.73	4.52	3.36
62°	4.31	5.49	8.07	9.80	12.11	12.92	12.73	10.87	8.55	6.80	4.70	3.65
61°	4.51	5.58	8.09	9.74	11.94	12.66	12.51	10.77	8.55	6.88	4.86	3.91
60°	4.70	5.67	8.11	9.69	11.78	12.41	12.31	10.68	8.54	6.95	5.02	4.14
59°	4.86	5.76	8.13	9.64	11.64	12.19	12.13	10.60	8.53	7.00	5.17	4.35
58°	5.02	5.84	8.14	9.59	11.50	12.00	11.96	10.52	8.53	7.06	5.30	4.54
57°	5.17	5.91	8.15	9.53	11.38	11.83	11.81	10.44	8.52	7.13	5.42	4.71
56°	5.31	5.98	8.17	9.48	11.26	11.68	11.67	10.36	8.52	7.18	5.52	4.87
55°	5.44	6.04	8.18	9.44	11.15	11.53	11.54	10.29	8.51	7.23	5.63	5.02
54°	5.56	6.10	8.19	9.40	11.04	11.39	11.42	10.22	8.50	7.28	5.74	5.16
53°	5.68	6.16	8.20	9.36	10.94	11.26	11.30	10.16	8.49	7.32	5.83	5.30
52°	5.79	6.22	8.21	9.32	10.85	11.14	11.19	10.10	8.48	7.36	5.92	5.42
51°	5.89	6.27	8.23	9.28	10.76	11.02	11.09	10.05	8.47	7.40	6.00	5.54
50°	5.99	6.32	8.24	9.24	10.68	10.92	10.99	9.99	8.46	7.44	6.08	5.65
49°	6.08	6.36	8.25	9.20	10.60	10.82	10.90	9.94	8.46	7.48	6.16	5.75
48°	6.17	6.41	8.26	9.17	10.52	10.72	10.81	9.89	8.45	7.51	6.24	5.85
47°	6.25	6.45	8.27	9.14	10.45	10.63	10.73	9.84	8.44	7.54	6.31	5.95
46°	6.33	6.50	8.28	9.11	10.38	10.53	10.65	9.79	8.43	7.58	6.37	6.05
45°	6.40	6.54	8.29	9.08	10.31	10.46	10.57	9.75	8.42	7.61	6.43	6.14
44°	6.48	6.57	8.29	9.05	10.25	10.39	10.49	9.71	8.41	7.64	6.50	6.22
43°	6.55	6.61	8.30	9.02	10.19	10.31	10.42	9.66	8.40	7.67	6.56	6.31
42°	6.61	6.65	8.30	8.99	10.13	10.24	10.35	9.62	8.40	7.70	6.62	6.39
41°	6.68	6.68	8.31	8.96	10.07	10.16	10.29	9.59	8.39	7.72	6.68	6.47
40°	6.75	6.72	8.32	8.93	10.01	10.09	10.22	9.55	8.39	7.75	6.73	6.54
39°	6.81	6.75	8.33	8.91	9.95	10.03	10.16	9.51	8.38	7.78	6.78	6.61
38°	6.87	6.79	8.33	8.89	9.90	9.96	10.11	9.47	8.37	7.80	6.83	6.68
37°	6.92	6.82	8.34	8.87	9.85	9.89	10.05	9.44	8.37	7.83	6.88	6.74
36°	6.98	6.85	8.35	8.85	9.80	9.82	9.99	9.41	8.36	7.85	6.93	6.81
35°	7.04	6.88	8.35	8.82	9.76	9.76	9.93	9.37	8.36	7.88	6.98	6.87
34°	7.10	6.91	8.35	8.80	9.71	9.71	9.88	9.34	8.35	7.90	7.02	6.93
33°	7.15	6.94	8.36	8.77	9.67	9.65	9.83	9.31	8.35	7.92	7.06	6.99
32°	7.20	6.97	8.36	8.75	9.62	9.60	9.77	9.28	8.34	7.95	7.11	7.05
31°	7.25	6.99	8.36	8.73	9.58	9.55	9.72	9.24	8.34	7.97	7.16	7.11
30°	7.31	7.02	8.37	8.71	9.54	9.49	9.67	9.21	8.33	7.99	7.20	7.16
29°	7.35	7.05	8.37	8.69	9.50	9.44	9.62	9.19	8.33	8.00	7.24	7.22
28°	7.40	7.07	8.37	8.67	9.46	9.39	9.58	9.17	8.32	8.02	7.28	7.27
27°	7.44	7.10	8.38	8.66	9.41	9.34	9.53	9.14	8.32	8.04	7.32	7.32
26°	7.49	7.12	8.38	8.64	9.37	9.29	9.49	9.11	8.32	8.06	7.36	7.37
25°	7.54	7.14	8.39	8.62	9.33	9.24	9.45	9.08	8.31	8.08	7.40	7.42
24°	7.58	7.16	8.39	8.60	9.30	9.19	9.40	9.06	8.31	8.10	7.44	7.47
23°	7.62	7.19	8.40	8.58	9.26	9.15	9.36	9.04	8.30	8.12	7.47	7.51
22°	7.67	7.21	8.40	8.56	9.22	9.11	9.32	9.01	8.30	8.13	7.51	7.56
21°	7.71	7.24	8.41	8.55	9.18	9.06	9.28	8.98	8.29	8.15	7.55	7.60

Table 2A-1 Monthly percentage of daytime hours (p) of the year for northern latitudes—Continued

Latitude N	Jan	Feb	Mar	Apr	May	Jun	Jul	Aug	Sep	Oct	Nov	Dec
20°	7.75	7.26	8.41	8.53	9.15	9.02	9.24	8.95	8.29	8.17	7.58	7.65
19°	7.79	7.28	8.41	8.51	9.12	8.97	9.20	8.93	8.29	8.19	7.61	7.70
18°	7.83	7.31	8.41	8.50	9.08	8.93	9.16	8.90	8.29	8.20	7.65	7.74
17°	7.87	7.33	8.42	8.48	9.04	8.89	9.12	8.88	8.28	8.22	7.68	7.79
16°	7.91	7.35	8.42	8.47	9.01	8.85	9.08	8.85	8.28	8.23	7.72	7.83
15°	7.94	7.37	8.43	8.45	8.98	8.81	9.04	8.83	8.27	8.25	7.75	7.88
14°	7.98	7.39	8.43	8.43	8.94	8.77	9.00	8.80	8.27	8.27	7.79	7.93
13°	8.02	7.41	8.43	8.42	8.91	8.73	8.96	8.78	8.26	8.29	7.82	7.97
12°	8.06	7.43	8.44	8.40	8.87	8.69	8.92	8.76	8.26	8.31	7.85	8.01
11°	8.10	7.45	8.44	8.39	8.84	8.65	8.88	8.73	8.26	8.33	7.88	8.05
10°	8.14	7.47	8.45	8.37	8.81	8.61	8.85	8.71	8.25	8.34	7.91	8.09
9°	8.18	7.49	8.45	8.35	8.77	8.57	8.81	8.68	8.25	8.36	7.95	8.14
8°	8.21	7.51	8.45	8.34	8.74	8.53	8.78	8.66	8.25	8.37	7.98	8.18
7°	8.25	7.53	8.46	8.32	8.71	8.49	8.74	8.64	8.25	8.38	8.01	8.22
6°	8.28	7.55	8.46	8.31	8.68	8.45	8.71	8.62	8.24	8.40	8.04	8.26
5°	8.32	7.57	8.47	8.29	8.65	8.41	8.67	8.60	8.24	8.41	8.07	8.30
4°	8.36	7.59	8.47	8.28	8.62	8.37	8.64	8.57	8.23	8.43	8.10	8.34
3°	8.40	7.61	8.48	8.26	8.58	8.33	8.60	8.55	8.23	8.45	8.13	8.38
2°	8.43	7.63	8.49	8.25	8.55	8.29	8.57	8.53	8.22	8.46	8.16	8.42
1°	8.47	7.65	8.49	8.23	8.52	8.25	8.53	8.51	8.22	8.48	8.19	8.45
0°	8.50	7.67	8.49	8.22	8.49	8.22	8.50	8.49	8.21	8.49	8.22	8.50

Seasonal consumptive-use coefficients

Consumptive-use coefficients (K) have been determined experimentally at numerous localities for most crops grown in the western states. Consumptive-use values (U) were measured, and these data were correlated with temperature and growing season. Crop consumptive-use coefficients were then computed by the formula:

$$K = \frac{U}{F}$$

The computed coefficients varied somewhat because of the diverse conditions, such as soils, water supply, and methods, under which the studies were conducted. These coefficients were adjusted where necessary after the data were analyzed. The resulting coefficients are believed to be suitable for use under normal conditions.

While only very limited investigations of consumptive use have been made in the Eastern or humid-area States, studies made thus far fail to indicate that there should be any great difference between the seasonal consumptive-use coefficients used there and those used in the Western States.

Table 2A-2 shows the values of seasonal consumptive-use crop coefficients currently proposed by Blaney-Criddle for most irrigated crops. Ranges in the values of these coefficients are shown. The values, however, are not all inclusive limits. In some circumstances, K values may be either higher or lower than shown.

Monthly or short-time consumptive-use coefficients

Although seasonal coefficients (K) as reported by various investigators show some variation for the same crops, monthly or short-time coefficients (k) show even greater variation. These great variations are influenced by a number of factors that must be considered when computing or estimating short-time coefficients. Although these factors are numerous, the most important are temperature and the growth stage of the crop.

Table 2A-2 Seasonal consumptive-use crop coefficients (K) for irrigated crops

Crop	Length of normal growing season or period ^{1/}	Consumptive-use coefficient (K) ^{2/}
Alfalfa	Between frosts	0.80 to 0.90
Bananas	Full year	.80 to 1.00
Beans	3 months	.60 to .70
Cocoa	Full year	.70 to .80
Coffee	Full year	.70 to .80
Corn (maize)	4 months	.75 to .85
Cotton	7 months	.60 to .70
Dates	Full year	.65 to .80
Flax	7 to 8 months	.70 to .80
Grains, small	3 months	.75 to .85
Grain, sorghum	4 to 5 months	.70 to .80
Oilseeds	3 to 5 months	.65 to .75
Orchard crops:		
Avocado	Full year	.50 to .55
Grapefruit	Full year	.55 to .65
Orange and lemon	Full year	.45 to .55
Walnuts	Between frosts	.60 to .70
Deciduous	Between frosts	.60 to .70
Pasture crops:		
Grass	Between frosts	.75 to .85
Ladino whiteclover	Between frosts	.80 to .85
Potatoes	3 to 5 months	.65 to .75
Rice	3 to 5 months	1.00 to 1.10
Soybeans	140 days	.65 to .70
Sugar beet	6 months	.65 to .75
Sugarcane	Full year	.80 to .90
Tobacco	4 months	.70 to .80
Tomatoes	4 months	.65 to .70
Truck crops, small	2 to 4 months	.60 to .70
Vineyard	5 to 7 months	.50 to .60

1/ Length of season depends largely on variety and time of year when the crop is grown. Annual crops grown during the winter period may take much longer than if grown in the summertime.

2/ The lower values of K for use in the Blaney-Criddle formula, $U=KF$, are for the more humid areas, and the higher values are for the more arid climates.

Growing season

In using the Blaney-Criddle formula for computing seasonal requirements, the potential growing season for the various crops is normally considered to extend from frost to frost or from the last killing frost in the spring to the end of a definite period thereafter. For most crops, this is adequate for seasonal use estimates, but a refinement is necessary to more precisely define the growing season when monthly or short-time use estimates are required. In many areas records are available from which planting, harvesting, and growth dates can be determined. These records should be used where possible. In other areas temperature data may be helpful for estimating these dates. Table 2A-3 gives some guides that can help determine these dates.

The spring frost date corresponds very nearly with a mean temperature of 55 degrees, so it is obvious that many of the common crops use appreciable amounts of water before the last frost in the spring and may continue to use water after the first front in the fall.

Climate coefficient (k_c)

While it is recognized that a number of climatological factors affect consumptive use by crops, seldom is complete climatological data on relative humidity, wind movement, sunshine hours, or pan evapotranspiration available for a specific site. Thus, it is necessary to rely on records of temperature that are widely available.

In 1954, J.T. Phelan attempted to correlate the monthly consumptive-use coefficient (k) with the mean monthly temperature (t). It was noted that a loop effect occurred in the plotted points—the computed values of (k) were higher in the spring than in the fall for the same temperature. The effects of this loop were later corrected by the development of a crop growth stage coefficient (k_c). The relationship between (k) and (t) was adopted for computing values of (k_c), the temperature coefficient. This relationship is expressed as $k_t = .0173t - .314$. Table 2A-4 gives values of k_t for temperatures ranging from 36 to 100 degrees Fahrenheit.

Table 2A-3 A guide for determining planting dates, maturity dates, and lengths of growing seasons as related to mean air temperature

Crops	Earliest moisture— Use or planting date as related to mean air temperature	Latest moisture— Use or maturing date as related to mean air temperature	Growing season days
Perennial crops			
Alfalfa	50° mean temp.	28° frost	Variable
Grasses, cool	45° mean temp.	45° mean temp.	Variable
Orchards, deciduous	50° mean temp.	45° mean temp.	Variable
Grapes	55° mean temp.	50° mean temp.	Variable
Annual crops			
Beans	60° mean temp.	32° frost	90 — 100
Corn	55° mean temp.	32° frost	140 — Max.
Cotton	62° mean temp.	32° frost	240 — Max.
Grain, spring	45° mean temp.	32° frost	130 — Max.
Potatoes, late	60° mean temp.	32° frost	130 — Max.
Sorghum, grain	60° mean temp.	32° frost	130 — Max.
Sugar beets	28° frost	28° frost	180 — Max.
Wheat, winter (fall season)		45° mean temp.	
(spring season)	45° mean temp.		

Crop growth stage coefficients (k_c)

As previously stated, another factor that causes consumptive use to vary widely throughout the growing season is the plant itself. Stage of growth is a primary variable that must be recognized because it is obvious that plants in the rapid growth stage use water at a more rapid rate than will new seedlings. It is also obvious that these variations in consumptive use throughout the growing season will be greater for annual crops than for perennial crops, such as alfalfa, permanent pasture grasses, and orchards.

Table 2A-4 Values of the climate coefficients (k_t) for various mean air temperatures (t)¹

t (°F)	k_t	t (°F)	k_t	t (°F)	k_t
36	.31	58	.69	80	1.07
37	.33	59	.71	81	1.09
38	.34	60	.72	82	1.11
39	.36	61	.74	83	1.12
40	.38	62	.76	84	1.14
41	.40	63	.78	85	1.16
42	.41	64	.79	86	1.17
43	.43	65	.81	87	1.19
44	.45	66	.83	88	1.21
45	.46	67	.85	89	1.23
46	.48	68	.86	90	1.24
47	.50	69	.88	91	1.26
48	.52	70	.90	92	1.28
49	.53	71	.91	93	1.30
50	.55	72	.93	94	1.31
51	.57	73	.95	95	1.33
52	.59	74	.97	96	1.35
53	.60	75	.98	97	1.36
54	.62	76	1.00	98	1.38
55	.64	77	1.02	99	1.40
56	.66	78	1.04	100	1.42
57	.67	79	1.05		

¹ Values of (k_t) are based on the formula, $k_t = .0173 t - .314$ for mean temperatures less than 36°, use $k_t = .300$.

To recognize these variations in consumptive use, crop growth stage coefficients (k_c) have been introduced into the formula. Values of these coefficients are calculated from research data. Where values of k_c are plotted against time or stage of growth, curves similar to those shown in figures 2A-1 through 2A-25 result. Such curves are used to obtain values of k_c that, when used with appropriate values of k_t will permit a determination of values of monthly or short-time consumptive-use coefficients (k).

Also, the value of k_c might to some extent be influenced by factors other than the characteristics of the plant itself. For this reason, it is not expected that these curves can be used universally. They should, however, be valid over a considerable area and certainly should be of value in areas where no measured consumptive-use data are available.

For annual crops, such as corn, values of k_c are best plotted as a function of a percentage of the growing season. Figure 2A-7 shows the suggested values of k_c for corn.

For perennial crops, values of k_c generally are best plotted on a monthly basis. Figure 2A-1 shows the plotting of such values for alfalfa. Crop growth stage coefficient curves for all crops for which data are available are in this appendix.

Assumptions in applying the formula

To apply results of a consumptive-use-of-water study in one area to other areas, certain assumptions must be made. If sufficient basic information is available locally, such actual data should be used; however, sufficient detail of the needed data is rarely available. Where necessary information is unavailable, the following assumptions must be made in applying the consumptive-use formula to transfer data between areas:

- Seasonal consumptive use (U) of water varies directly with the consumptive-use factor (F).
- Crop growth and yields are not limited by inadequate water at any time during the growing season.

- Growing periods for alfalfa, pasture, orchard crops, and natural vegetation, although usually extending beyond the frost-free periods, are usually indicated by such periods. Yields of crops dependent only upon vegetative growth vary with the length of the growing period.

midpoint date for each month or fraction is shown in column 2. The accumulated number of days from the planting date, April 20, to the midpoint of each month or period is shown in column 3. The percentage of the 120-day growing season represented by these midpoint dates is shown in column 4. Thus:

$$\text{column 4} = \frac{\text{column 3}}{120}$$

Application to specific areas

The application of the Blaney-Criddle formula to specific areas can best be illustrated by examples. Two have been chosen for this purpose. The first is an annual crop, corn, grown in a humid area, Raleigh, North Carolina. The second is a perennial crop, alfalfa, grown in an arid area, Denver, Colorado.

Corn at Raleigh, North Carolina

The procedure for estimating the average daily, monthly, and seasonal consumptive use by corn at this location is shown in sample calculation 2A-1. The average length of the growing season for corn grown near Raleigh is 120 days beginning about April 20.

The estimate is made on a monthly basis, the months and fractions thereof being shown in column 1. The

Mean monthly air temperature values, shown in column 5, are taken from Weather Bureau records. The mean temperature is assumed to occur on the 15th day of each month. The mean air temperature for a part of a month can be obtained mathematically or graphically by assuming that the increase or decrease in temperature between the 15th day of any consecutive month is a straight-line relationship. For example, at Raleigh, the mean monthly air temperature for April is 60.6 degrees and that for May is 69.2 degrees. The mean air temperature for the midpoint date is calculated as follows:

$$60.6^{\circ} + \frac{10 \text{ days} (69.2^{\circ} - 60.6^{\circ})}{30 \text{ days}} = 63.5^{\circ}$$

Sample calculation 2A-1 Estimate of average daily, monthly, and seasonal consumptive-use by corn (harvested for grain) at Raleigh, North Carolina, latitude 35°47' N

(1) Month or period	(2) Midpoint of period	(3) Accum. days to midpoint	(4) Percent of growing season	(5) Mean air temp., t (°F)	(6) Daylight hours, p (%)	(7) Cons. use factor, f	(8) Climatic coeff., k _t	(9) Growth stage coeff., k _c	(10) Cons. use coeff., k	(11) Monthly cons. use, u (in)	(12) Daily cons. use, u (in/d)
April 20											
	April 25	5	4.2	63.5	3.05	1.94	.79	.46	.36	.70	.070
May											
	May 15	25	20.8	69.2	9.79	6.77	.88	.59	.52	3.52	.114
June											
	June 15	56	46.7	76.9	9.81	7.54	1.02	1.02	1.04	7.84	.261
July											
	July 15	86	71.7	79.4	9.98	7.92	1.06	1.05	1.11	8.79	.284
August											
	Aug. 9	111	92.5	78.3	5.52	4.32	1.04	.91	.95	4.10	.228
Aug. 18											
Season total											24.95 inches

Raleigh is located at latitude 35°47' N. The monthly percentages of daylight hours, shown in column 6, are taken from table 2A-1. For parts of a month, the values of these percentages can be obtained in a similar manner as that described for mean air temperature. For example, at Raleigh, the monthly percentage of daylight hours for April is 8.84 and that for May is 9.79. For the period April 20 through April 30, the monthly percentage of daylight hours is calculated as:

$$\left(8.84\% + \frac{10 \text{ days}(9.79\% - 8.84\%)}{30 \text{ days}} \right) \frac{10 \text{ days}}{30 \text{ days}} = 3.05\%$$

The values of consumptive use factors (f) shown in column 7 are the product of t and p divided by 100. Values of the climatic coefficient (k_t) shown in column 8 are taken from table 2A-4. Values of the crop growth stage coefficient (k_c) shown in column 9 are taken from the curve shown in figure 2A-7. The values of the monthly consumptive-use coefficient (k) shown in

column 10 are the product of k_t and k_c . Values of monthly consumptive use (u) shown in column 11 are the product of values of k and f. The average daily rates of consumptive use shown in column 12 are the monthly values of u (column 11) divided by the number of days in the month.

Alfalfa in Denver, Colorado

The procedure for estimating the average daily, monthly, and seasonal consumptive use by alfalfa in this location is shown in sample calculation 2A-2. The growing season for alfalfa grown near Denver is considered to be that period from the date corresponding to 50° mean temperature in the spring to the date corresponding to 28° frost in the fall. This period is from April 24 to October 25.

The procedure illustrated by sample calculation 2A-2 is the same as that described for corn in sample calculation 2A-1. The values of the crop growth stage coefficient (k_c) shown in column 8 are taken from the curve for alfalfa shown in figure 2A-1.

Sample calculation 2A-2 Estimate of average daily, monthly, and seasonal consumptive use by alfalfa at Denver, Colorado

(1) Month or period	(2) Midpoint of period	(3) Days in period	(4) Mean air temp, t (°F)	(5) Daylight hours, p (%)	(6) Cons. use factor, f	(7) Climatic coeff., k_t	(8) Growth stage coeff., k_c	(9) Cons. use coeff., k	(10) Monthly cons. use, u (in/mo)	(11) Daily cons. use, u (in/d)
April 24	April 27	6	51.1	1.87	0.96	0.57	1.03	0.59	0.57	0.095
May	May 15	31	56.3	9.99	5.62	0.66	1.08	0.71	3.99	0.129
June	June 15	30	66.4	10.07	6.69	0.84	1.13	0.95	6.36	0.212
July	July 15	31	72.8	10.20	7.43	0.95	1.11	1.05	7.80	0.252
August	August 15	31	71.3	9.54	6.80	0.92	1.06	0.98	6.66	0.215
September	Sept. 15	30	62.7	8.39	5.26	0.77	0.99	0.76	4.00	0.133
October	Oct. 12	25	53.5	6.31	3.38	0.61	0.91	0.56	1.89	0.076
Oct. 25										
Seasonal total									31.27 inches	

Figure 2A-1 Crop growth stage coefficient curve for alfalfa

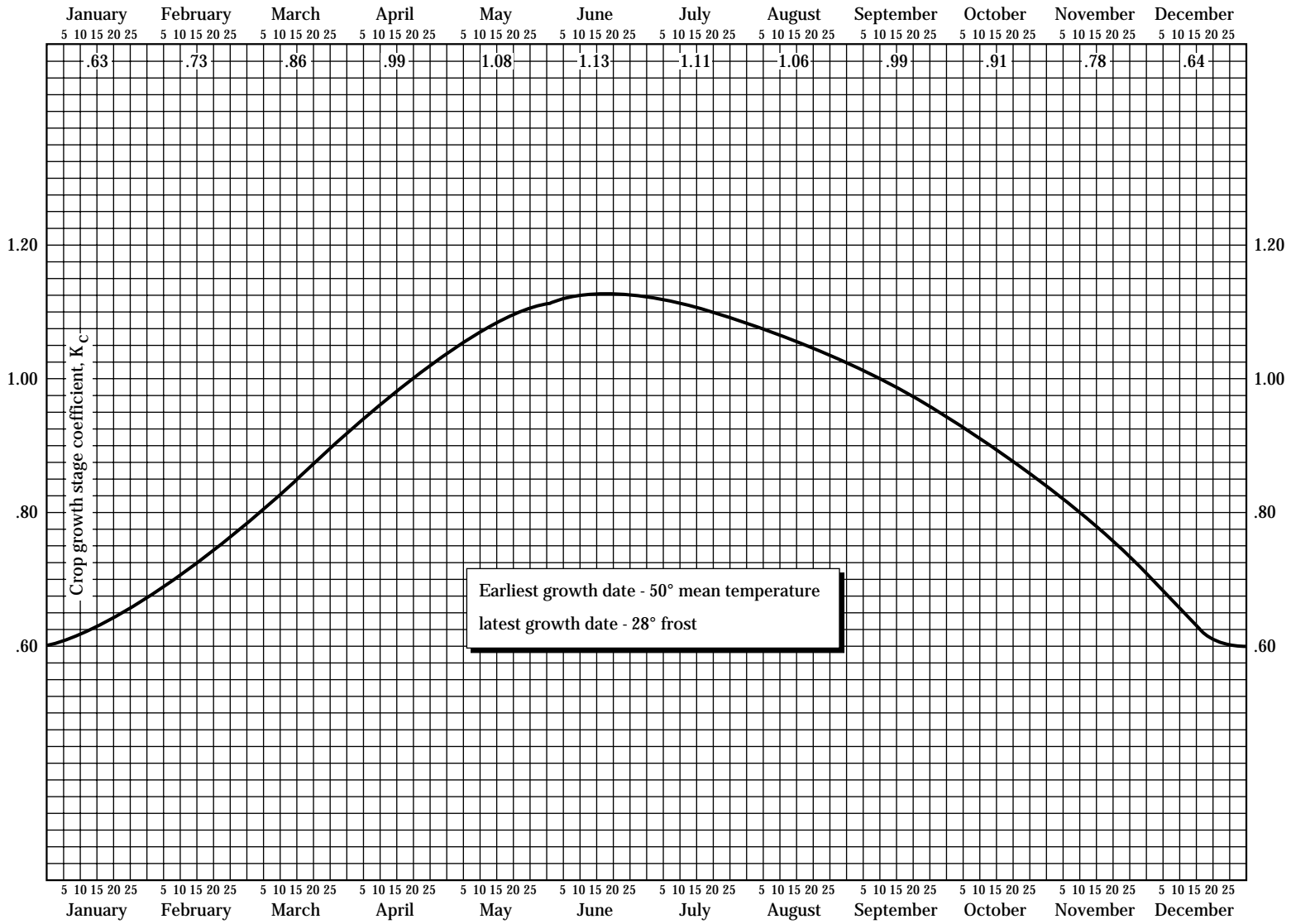

Figure 2A-2 Crop growth stage coefficient curve for avocados

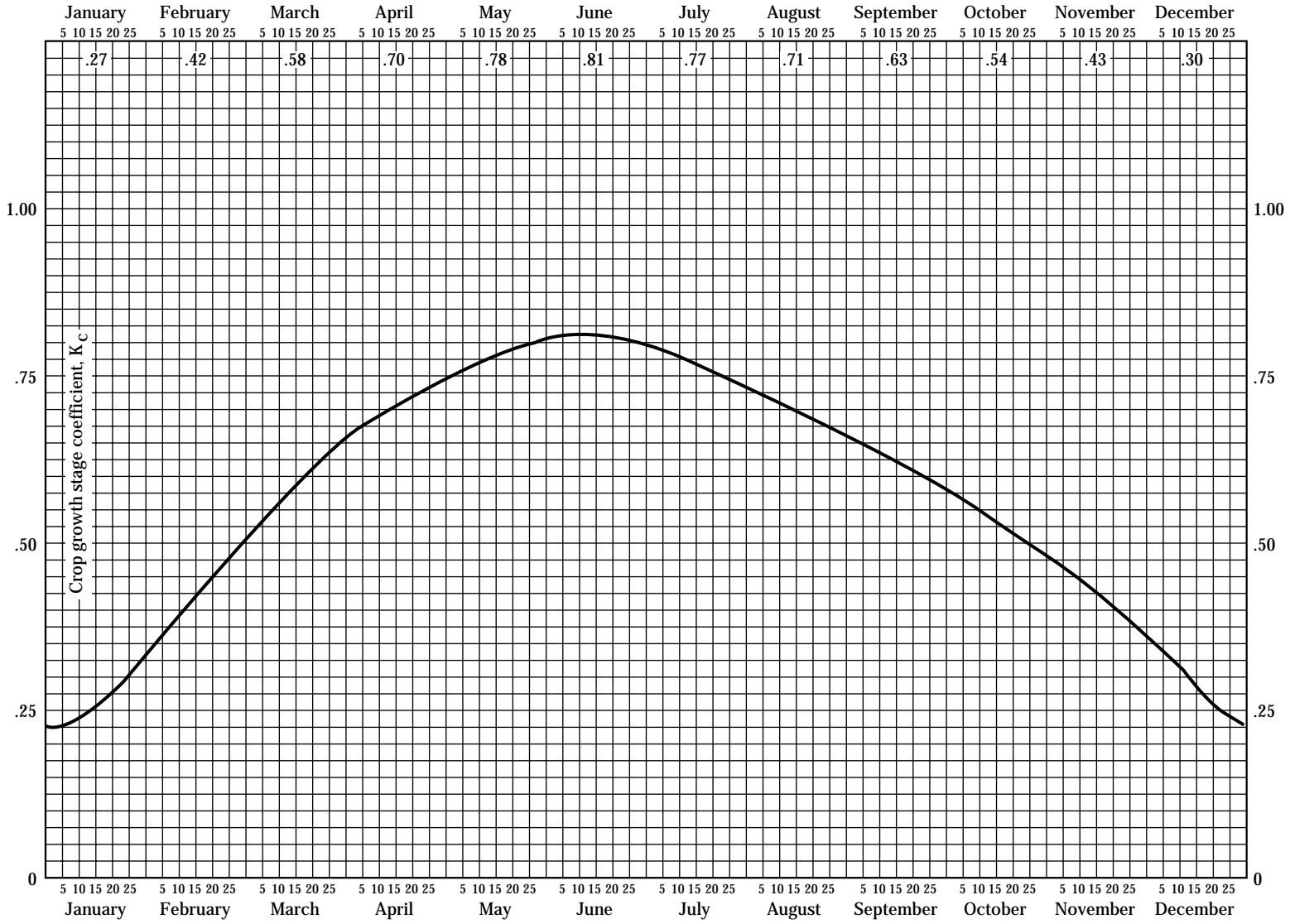

Figure 2A-3 Crop growth stage coefficient curve for dry beans

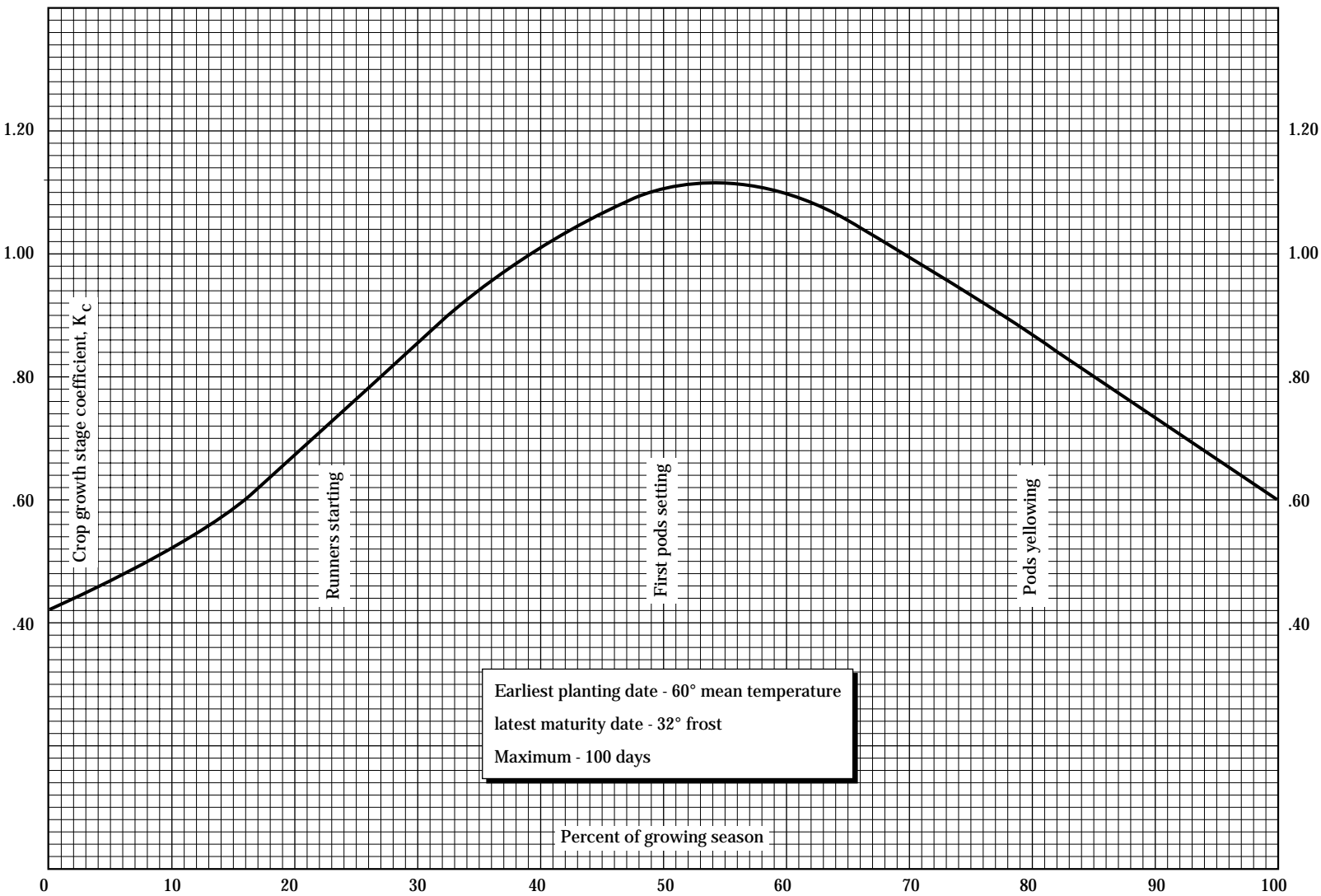

Figure 2A-4 Crop growth stage coefficient curve for snap beans

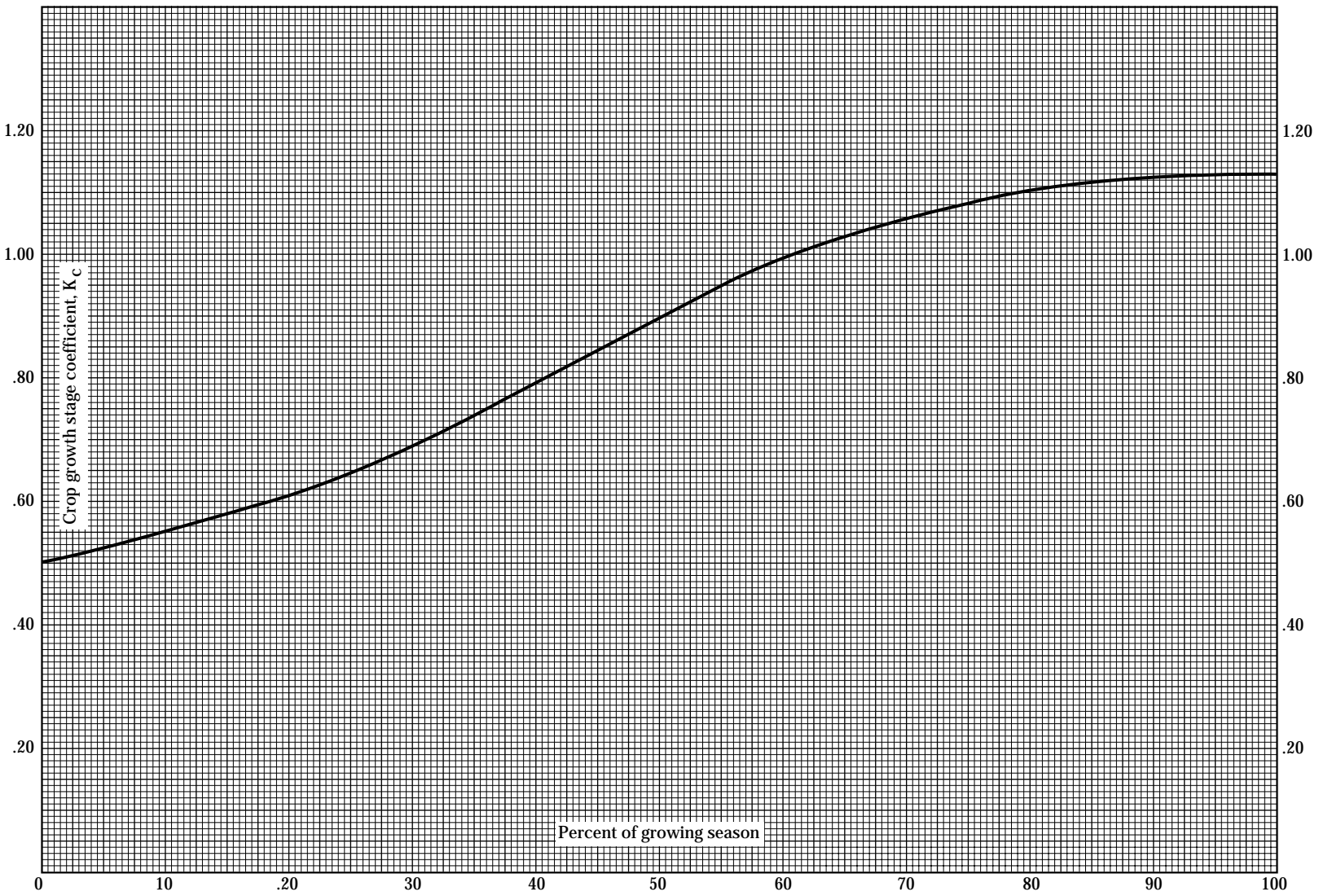

Figure 2A-5 Crop growth stage coefficient curve for sugar beets

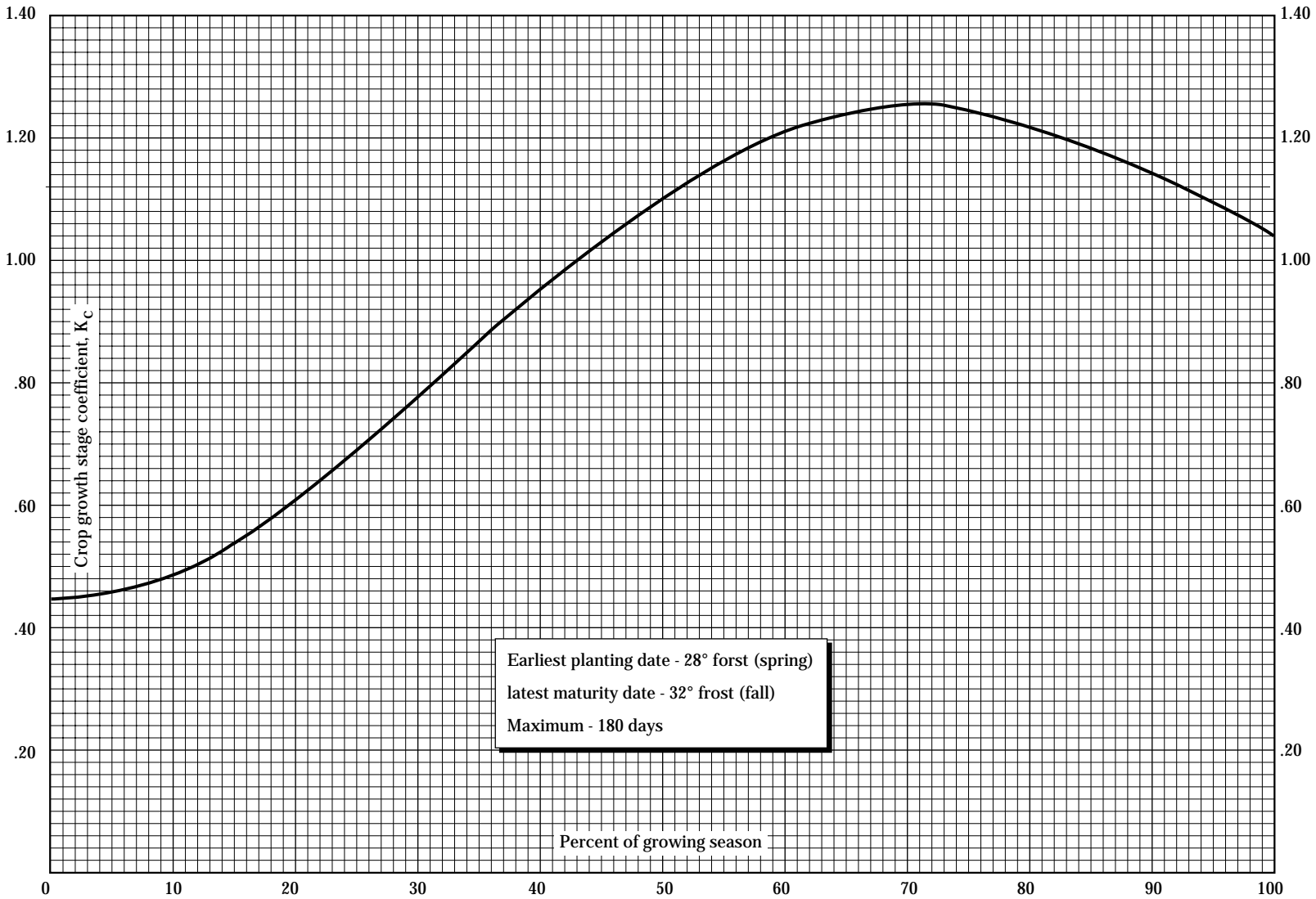

Figure 2A-6 Crop growth stage coefficient curve for citrus

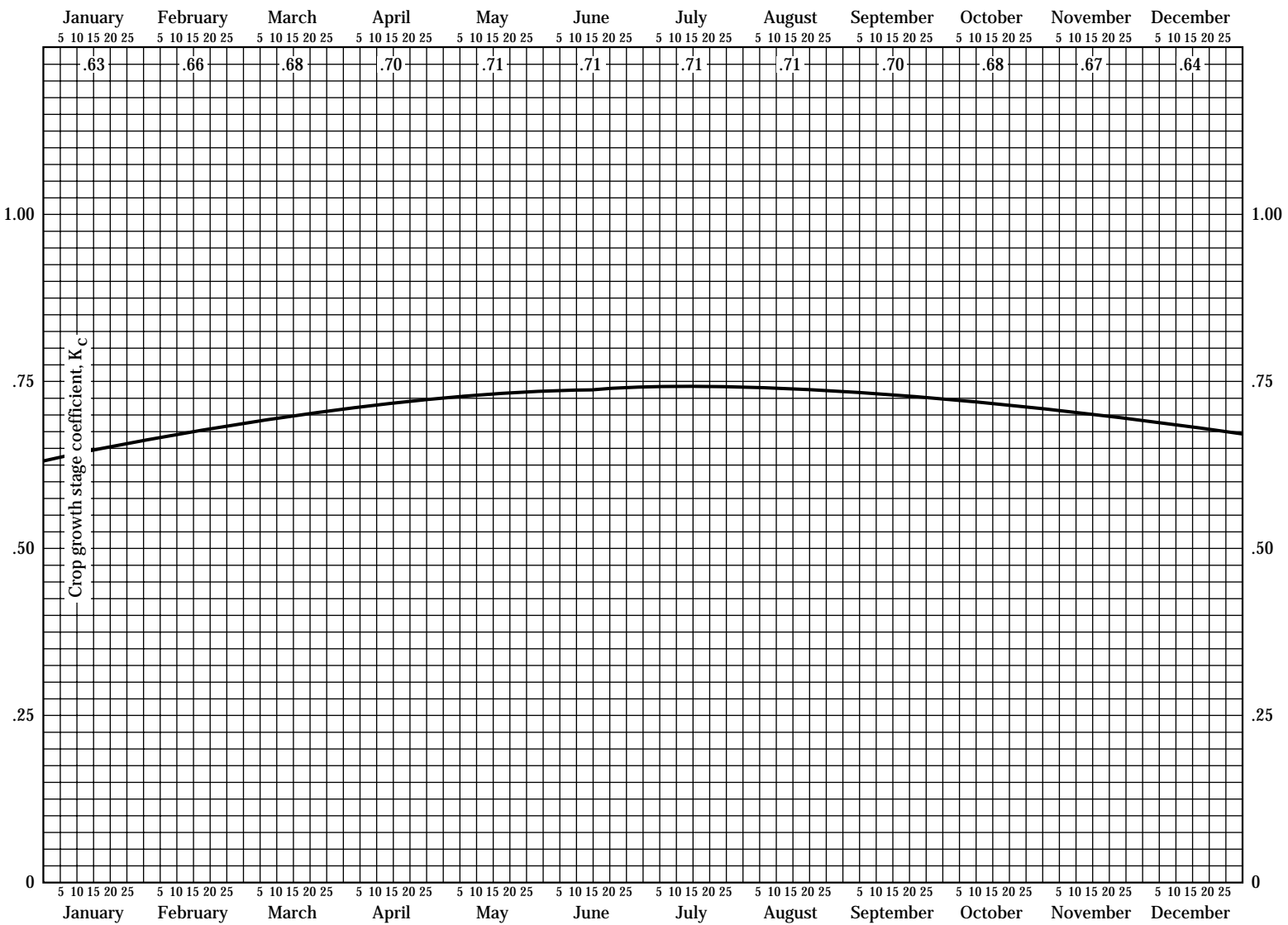

Figure 2A-7 Crop growth stage coefficient curve for corn (grain)

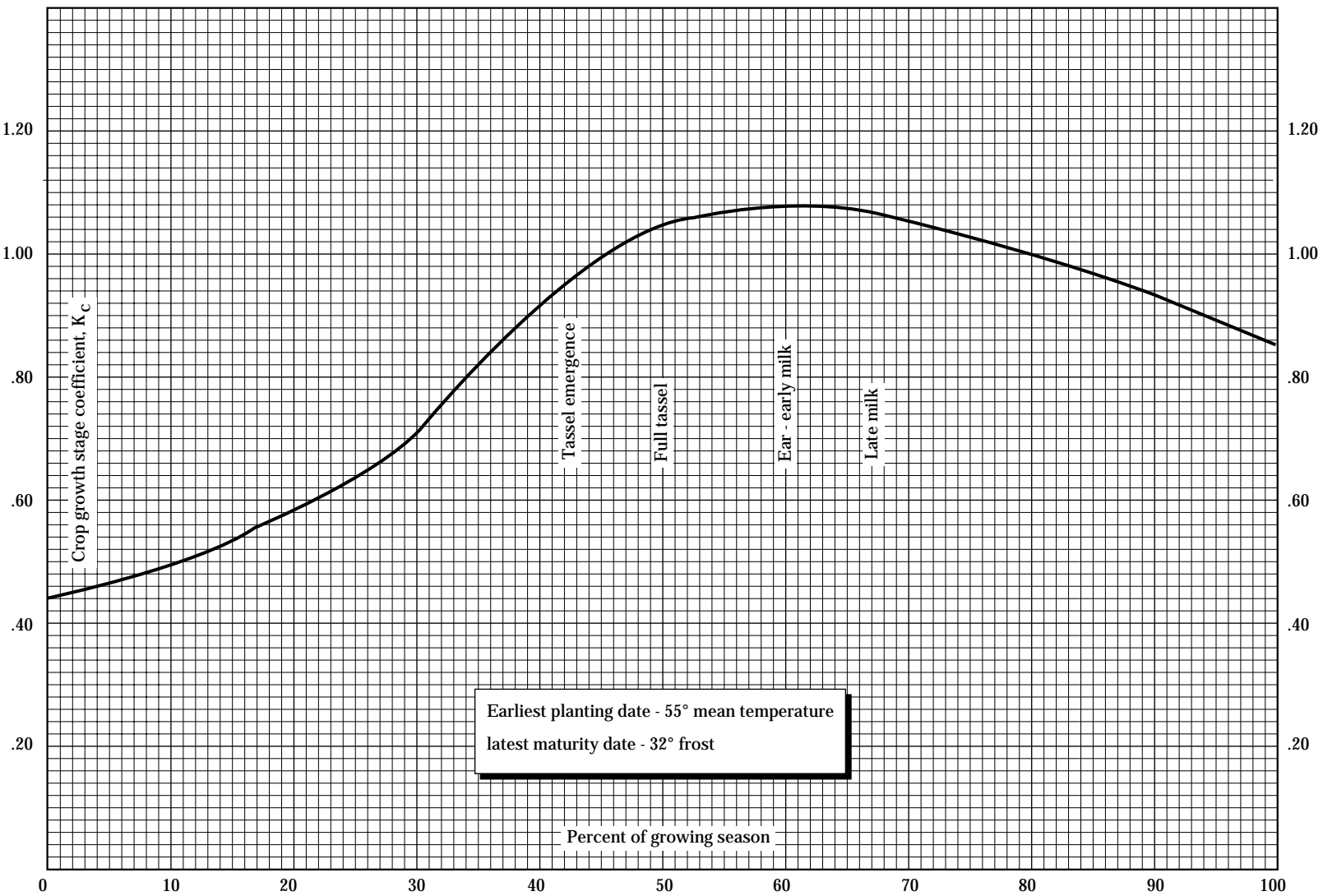

Figure 2A-8 Crop growth stage coefficient curve for corn (silage)

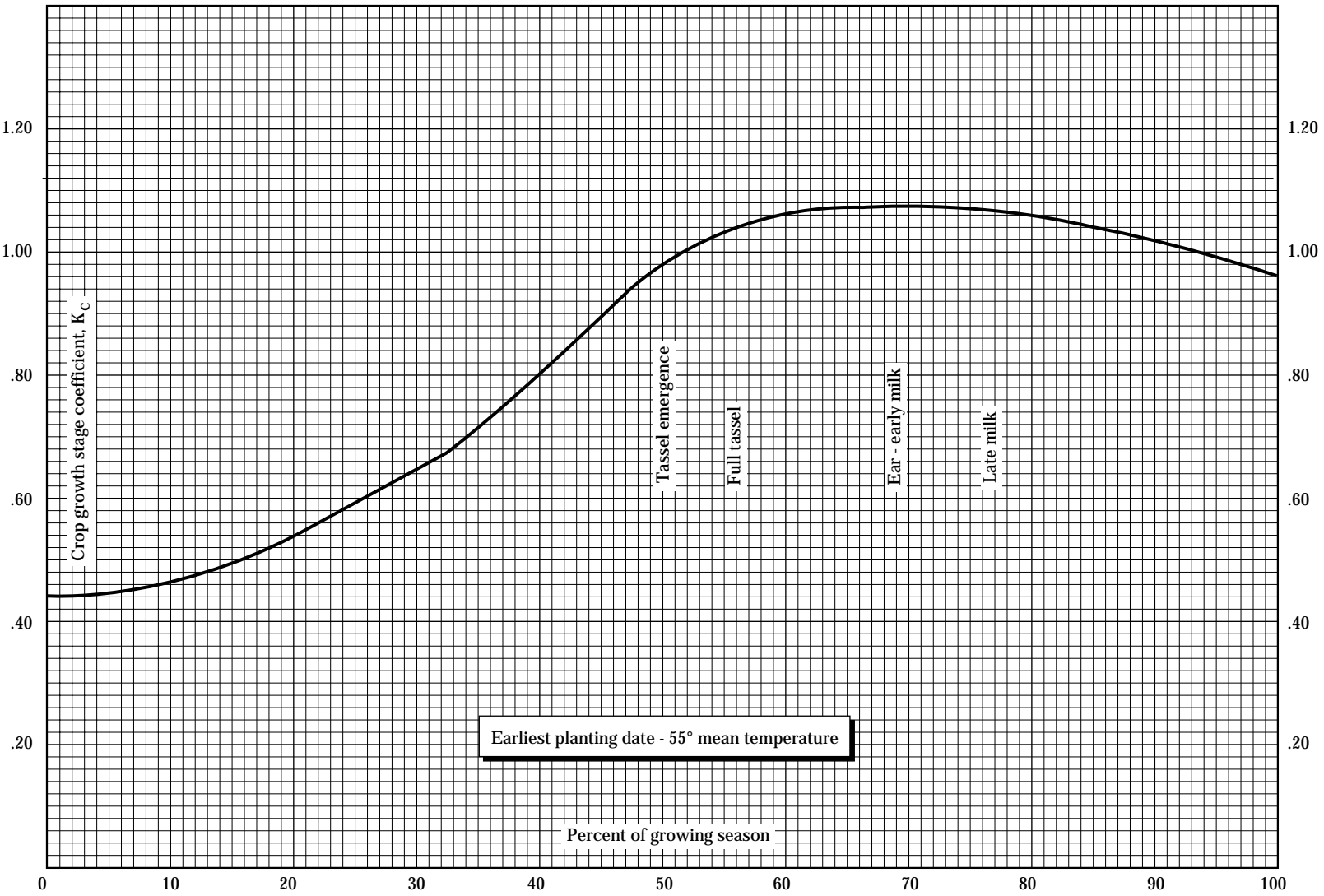

Figure 2A-9 Crop growth stage coefficient curve for sweet corn

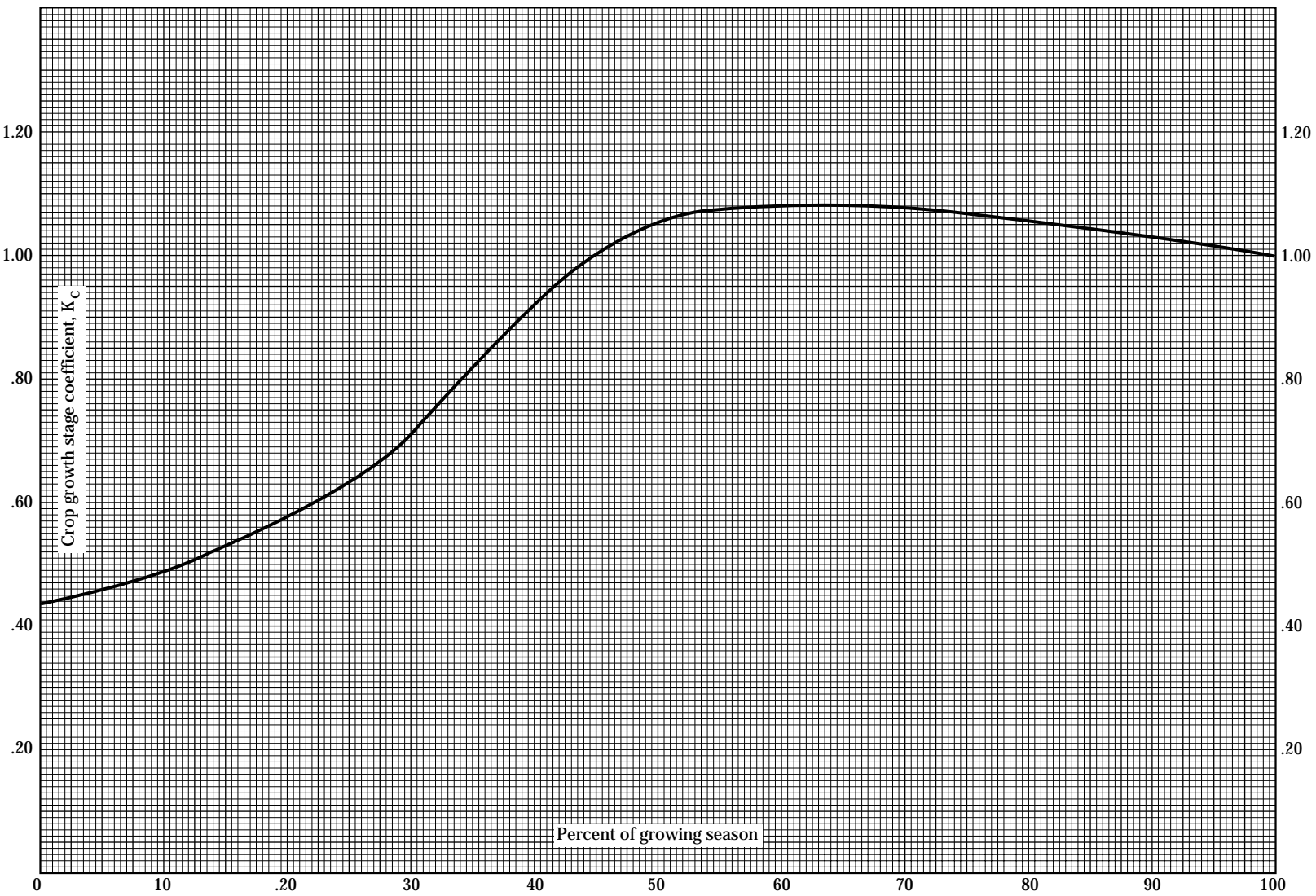

Figure 2A-10 Crop growth stage coefficient curve for cotton

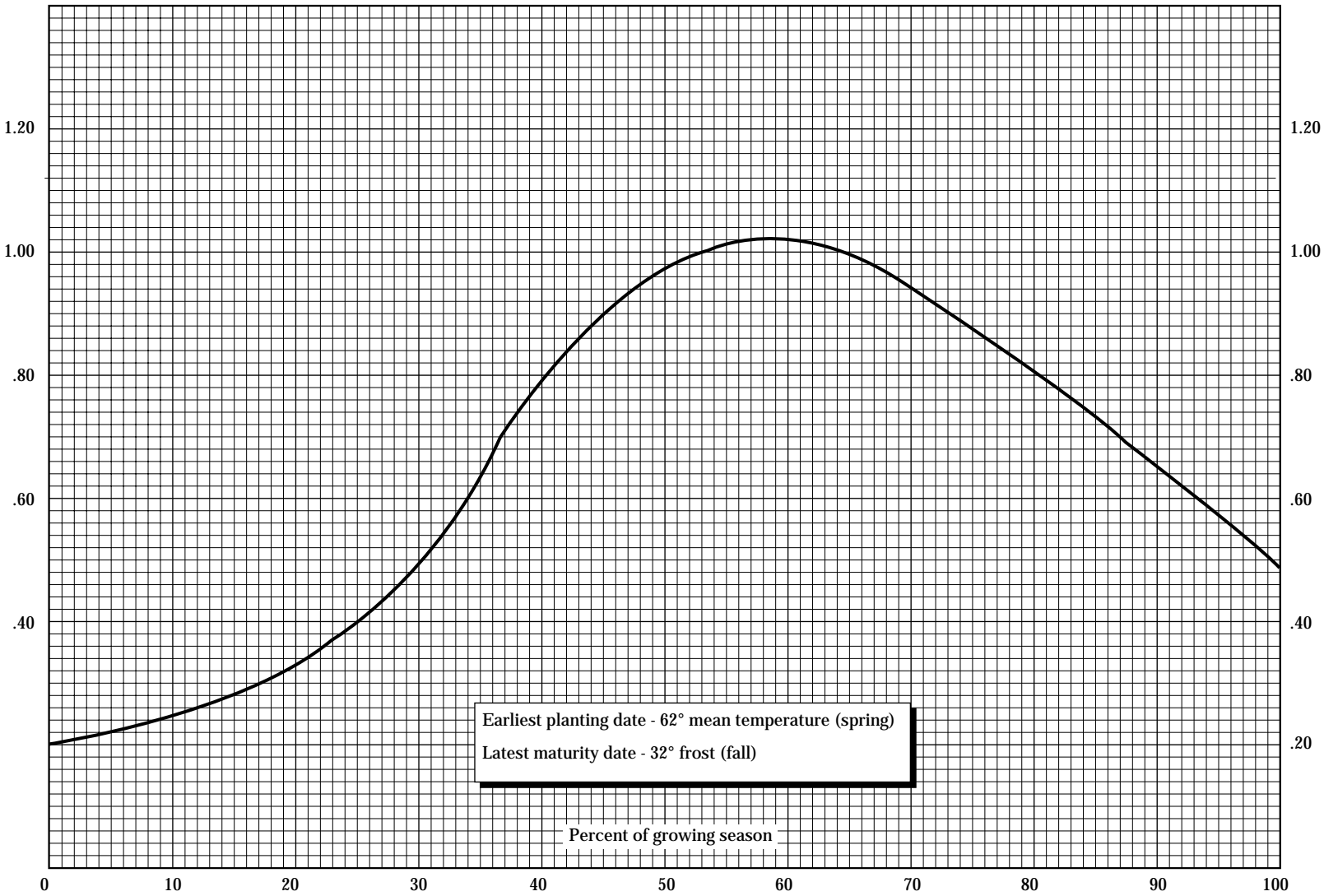

Figure 2A-11 Crop growth stage coefficient curve for spring grain

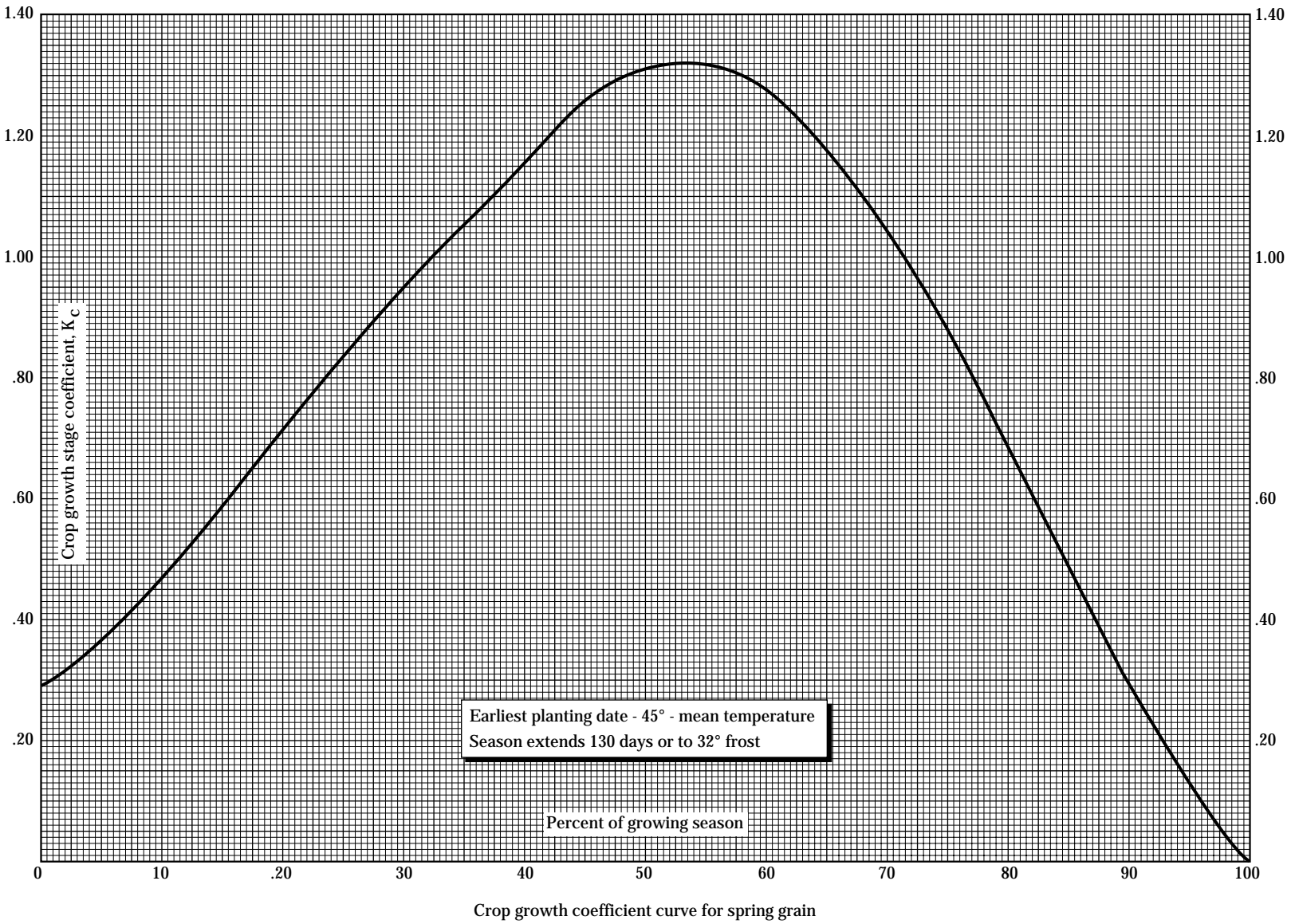

Figure 2A-12 Crop growth stage coefficient curve for grapes

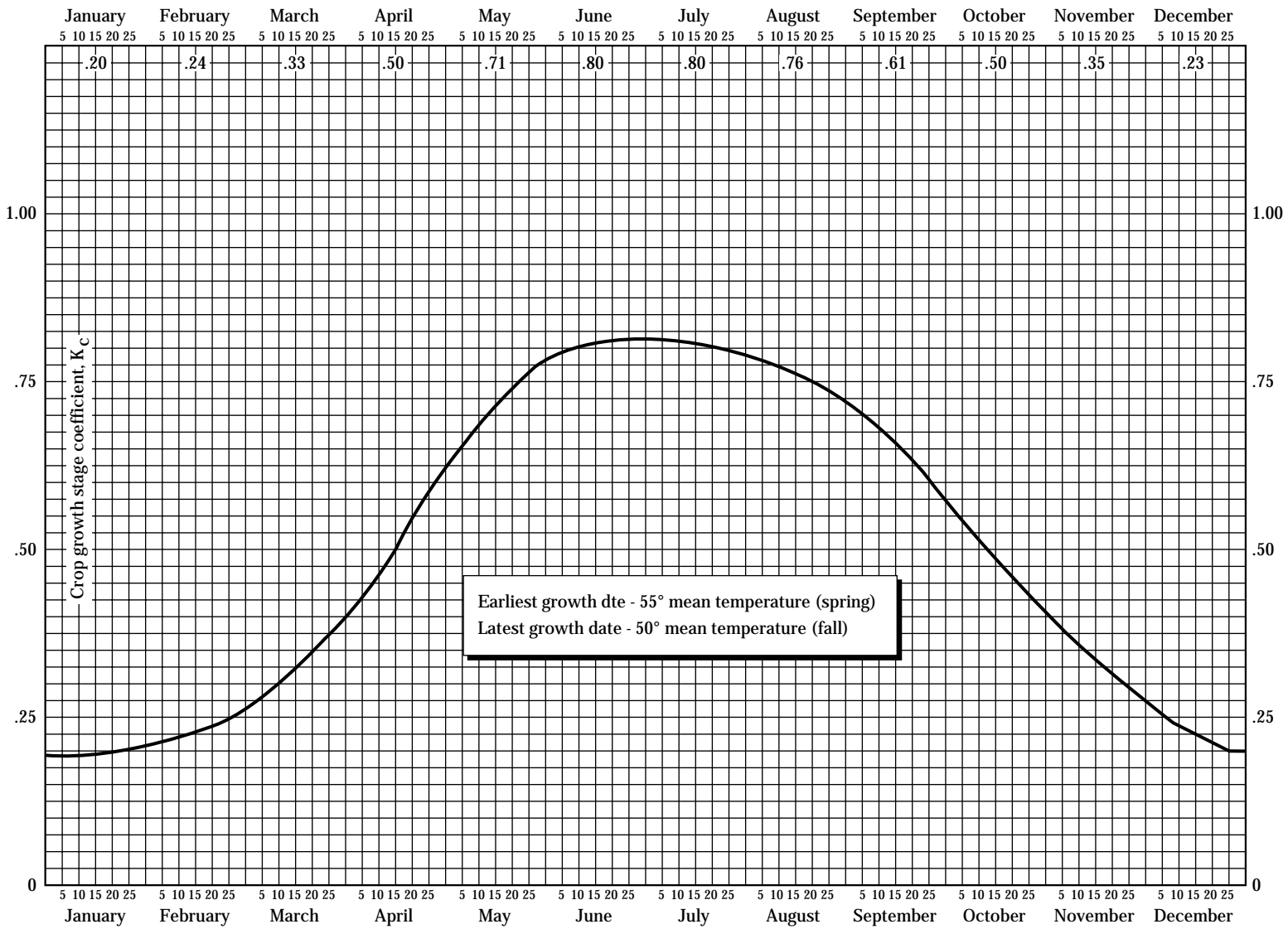

Figure 2A-13 Crop growth stage coefficient curve for melons and cantaloupes

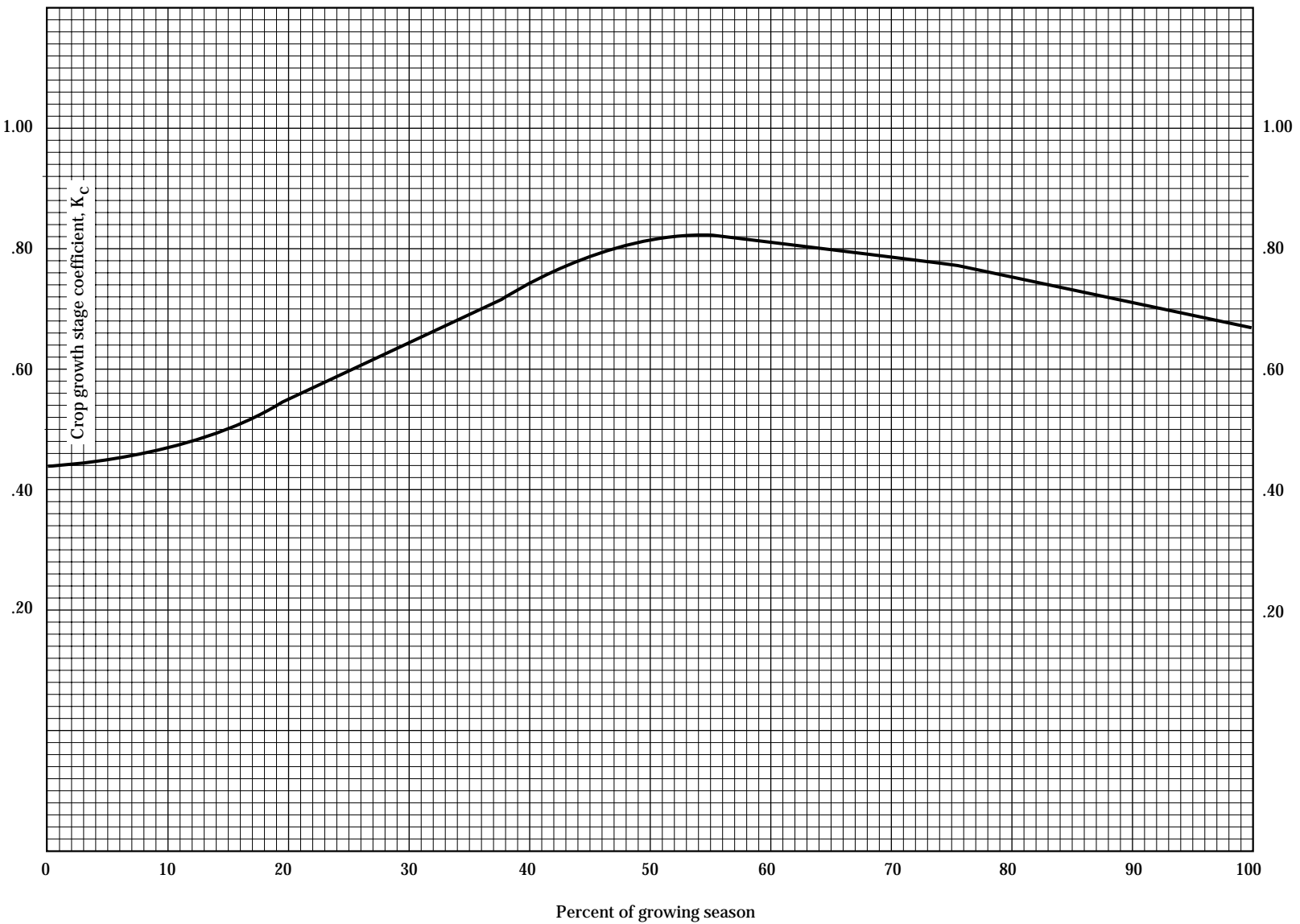

Figure 2A-14 Crop growth stage coefficient curve for deciduous orchards

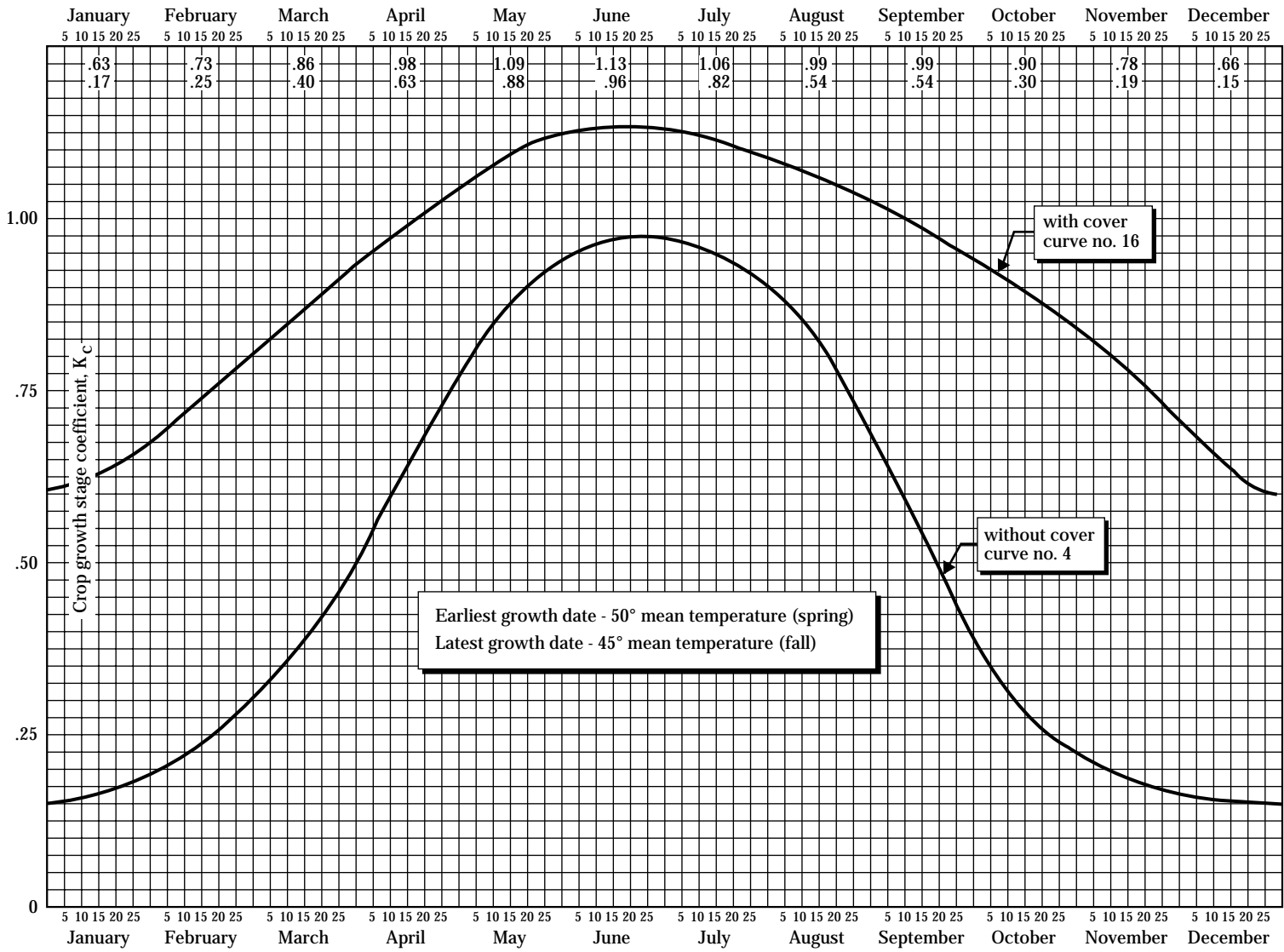
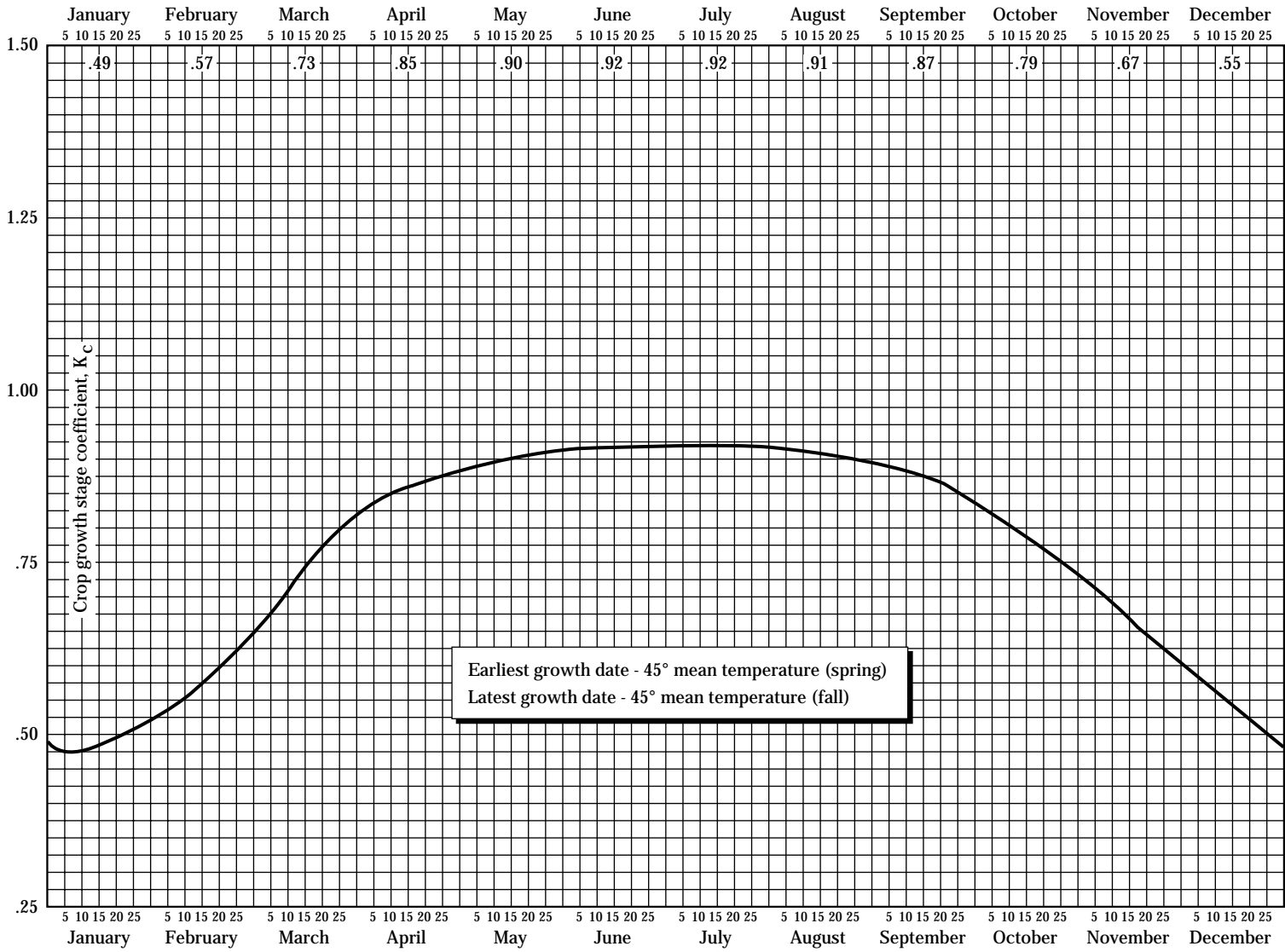

Figure 2A-15 Crop growth stage coefficient curve for pasture grasses



Earliest growth date - 45° mean temperature (spring)
 Latest growth date - 45° mean temperature (fall)

Figure 2A-16 Crop growth stage coefficient curve for peas

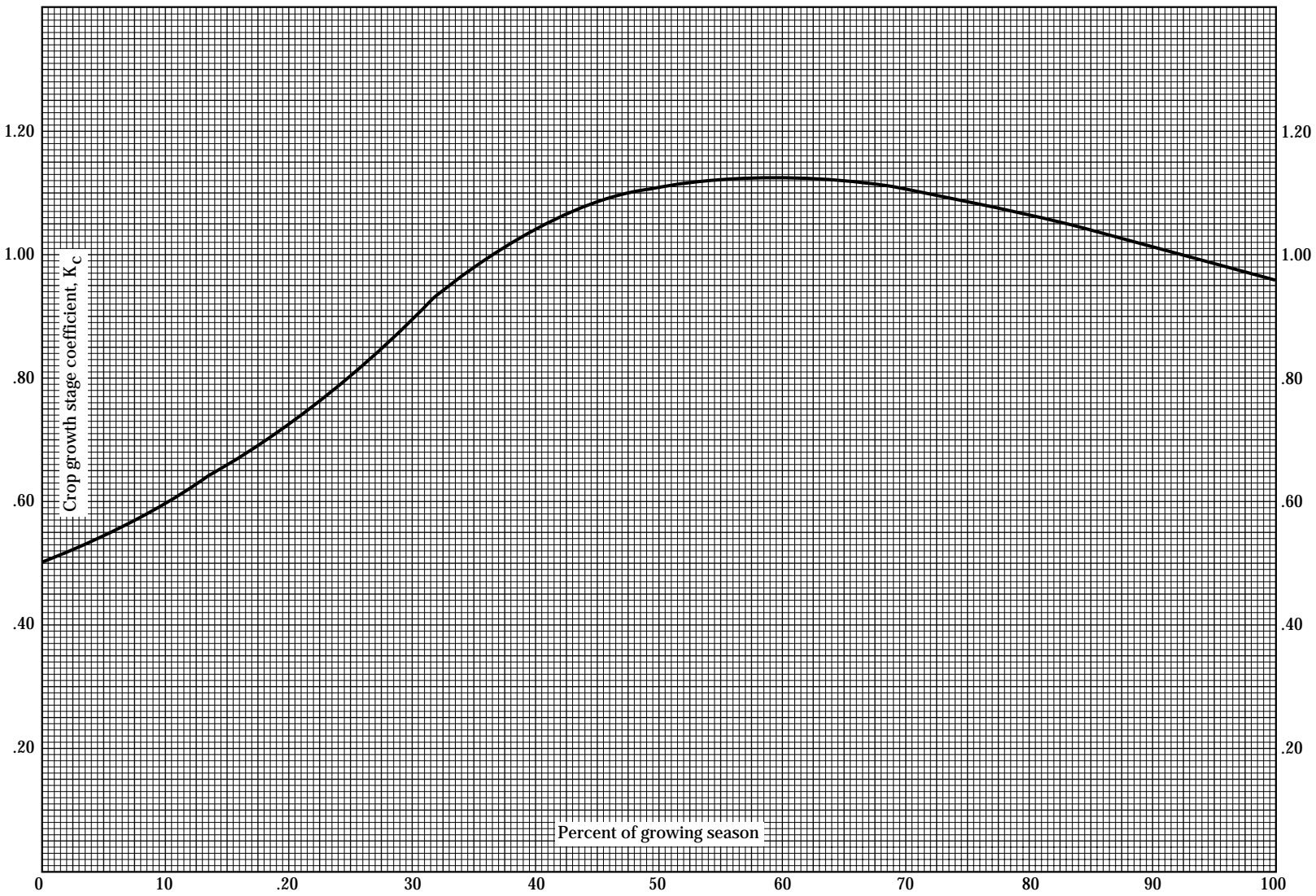

Figure 2A-17 Crop growth stage coefficient curve for Irish potatoes

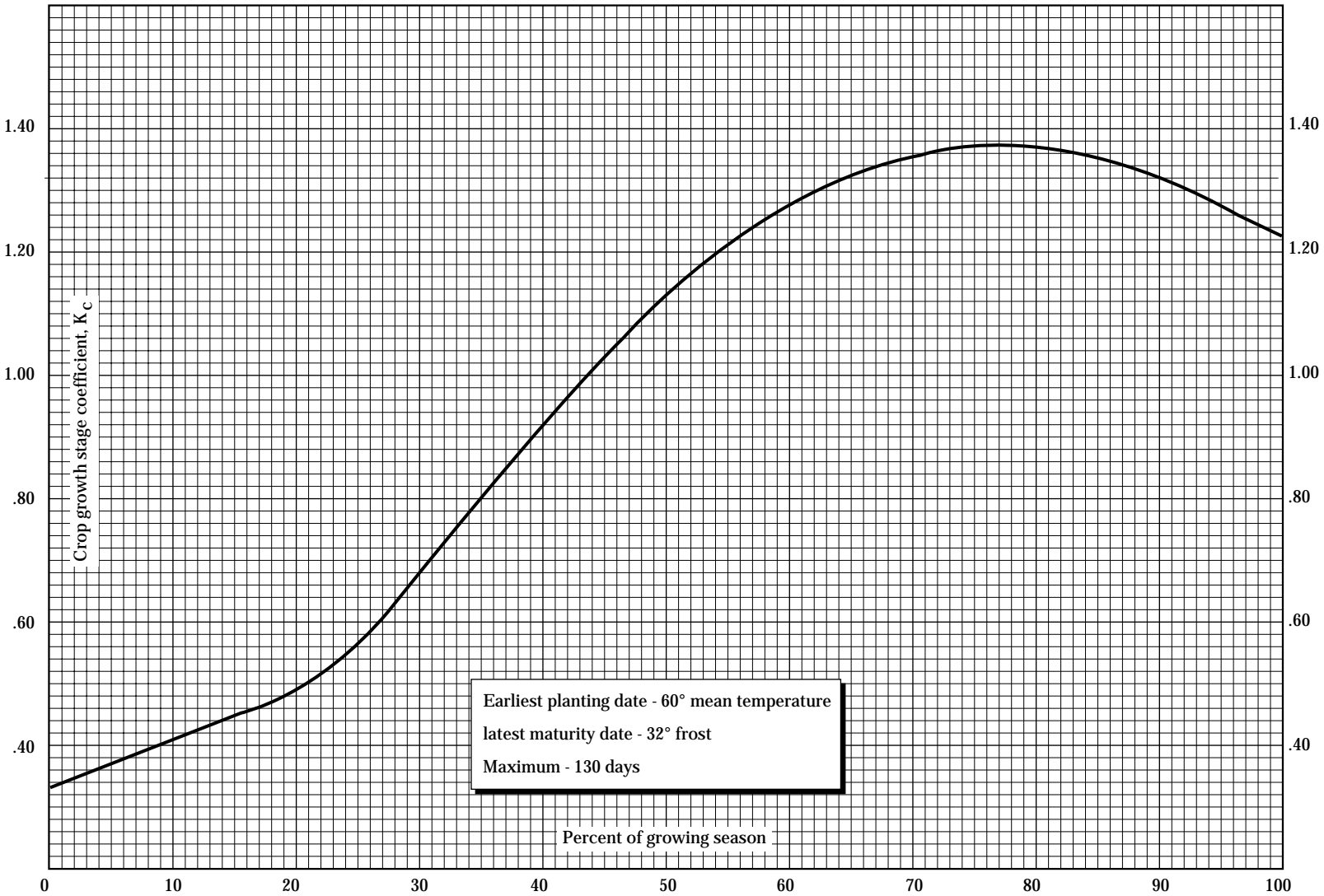

Figure 2A-18 Crop growth stage coefficient curve for grain sorghum

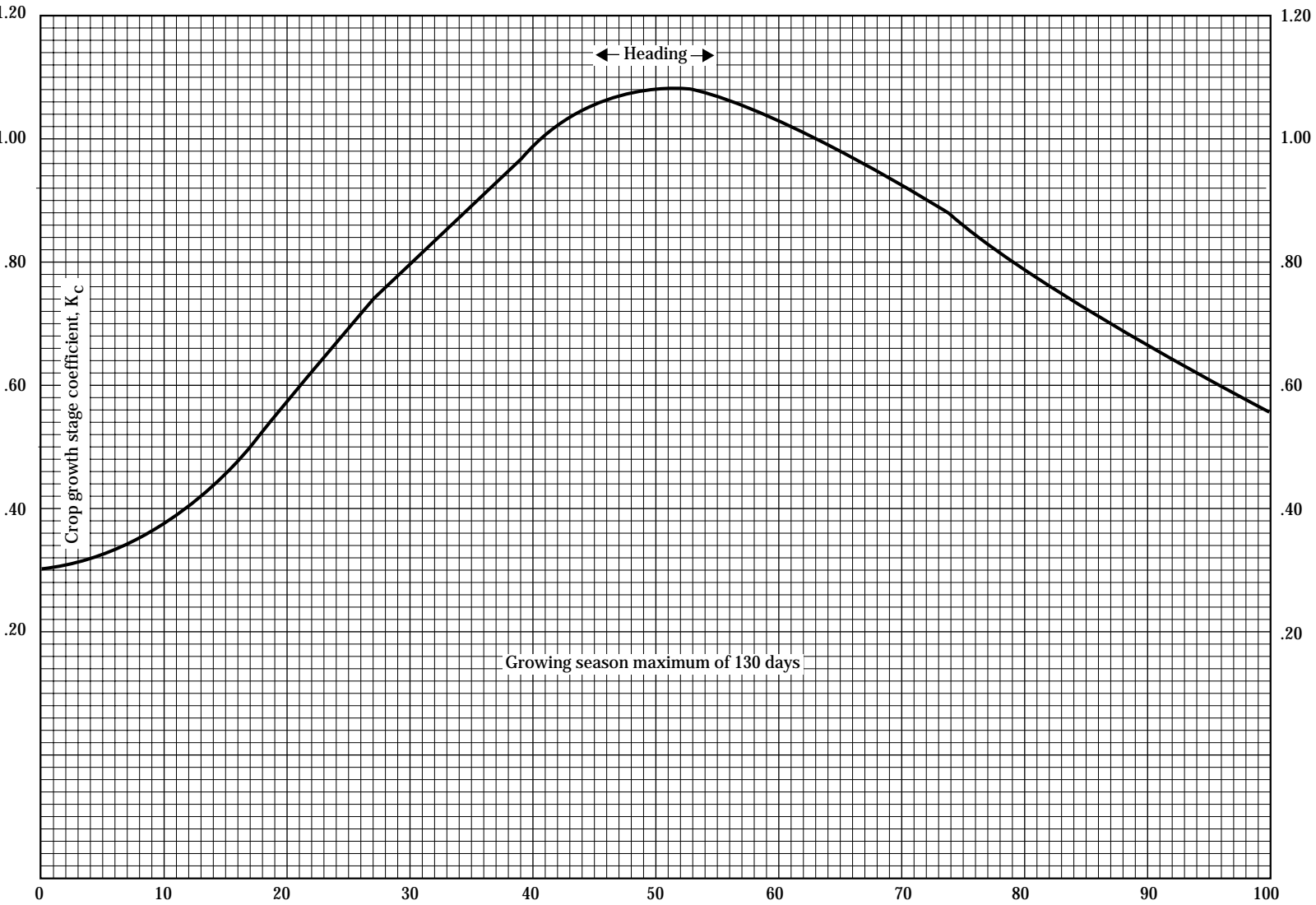
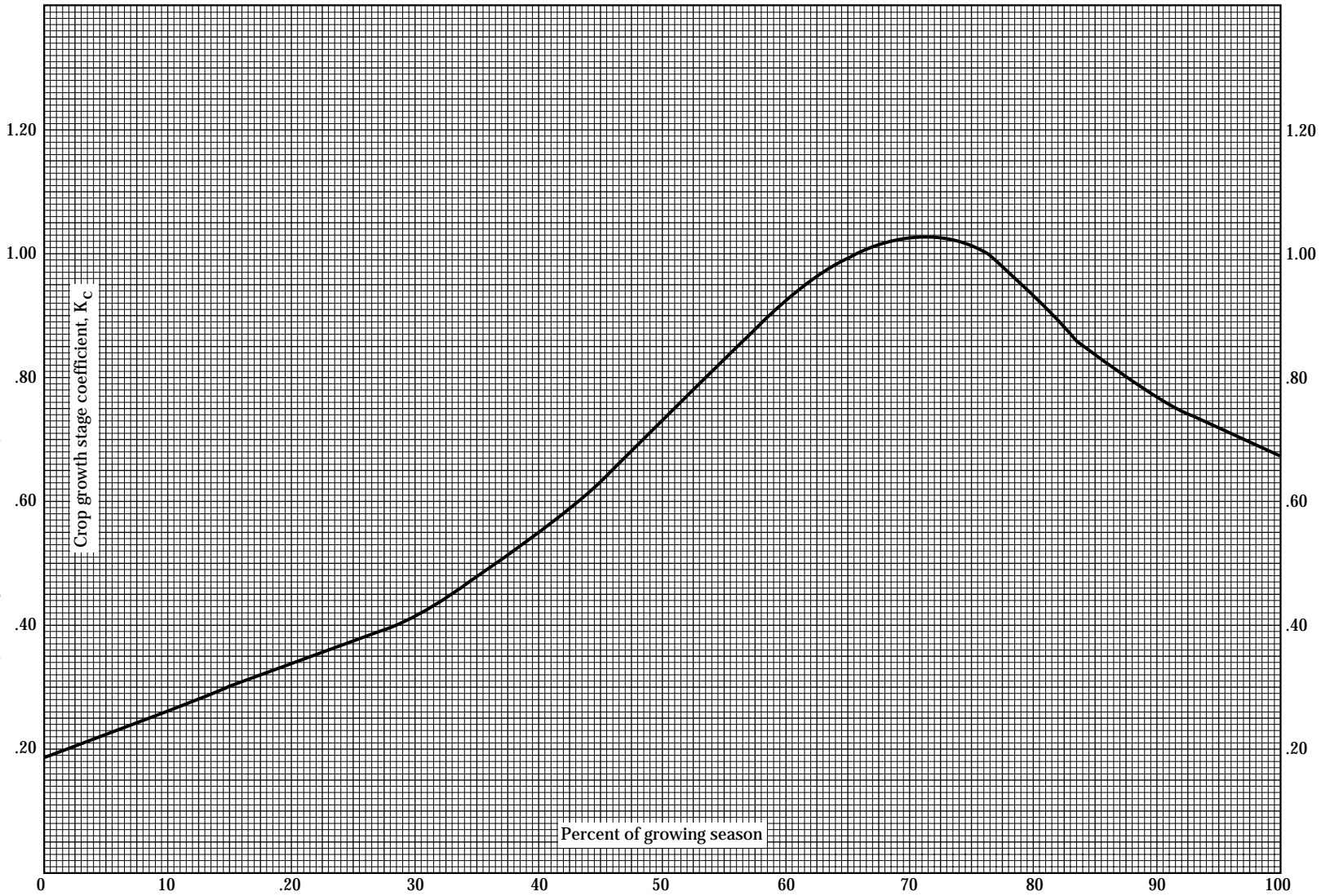

Figure 2A-19 Crop growth stage coefficient curve for soybeans



(210-vi-NEH, September 1993)

Figure 2A-20 Crop growth stage coefficient curve for tomatoes

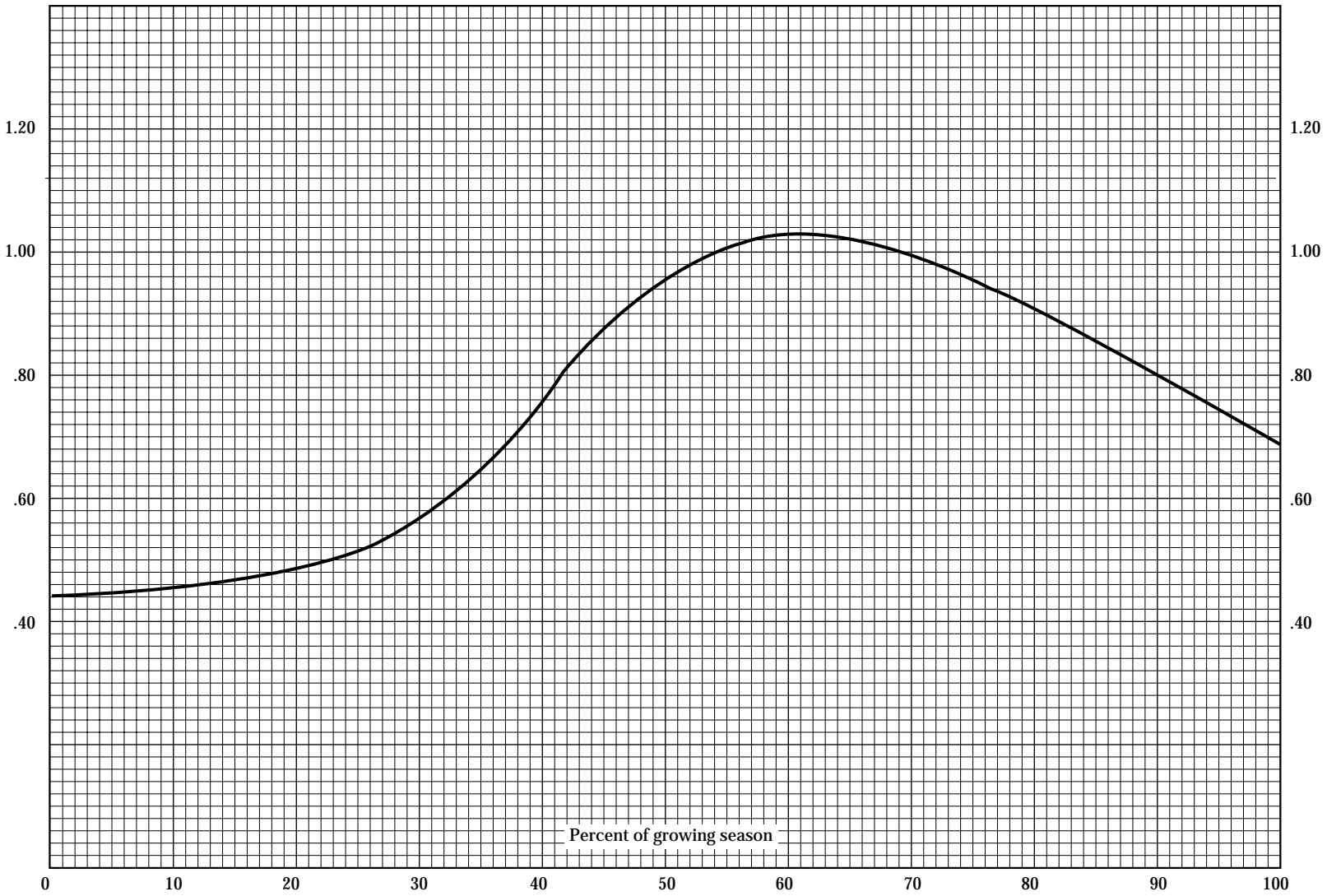

Figure 2A-21 Crop growth stage coefficient curve for small vegetables

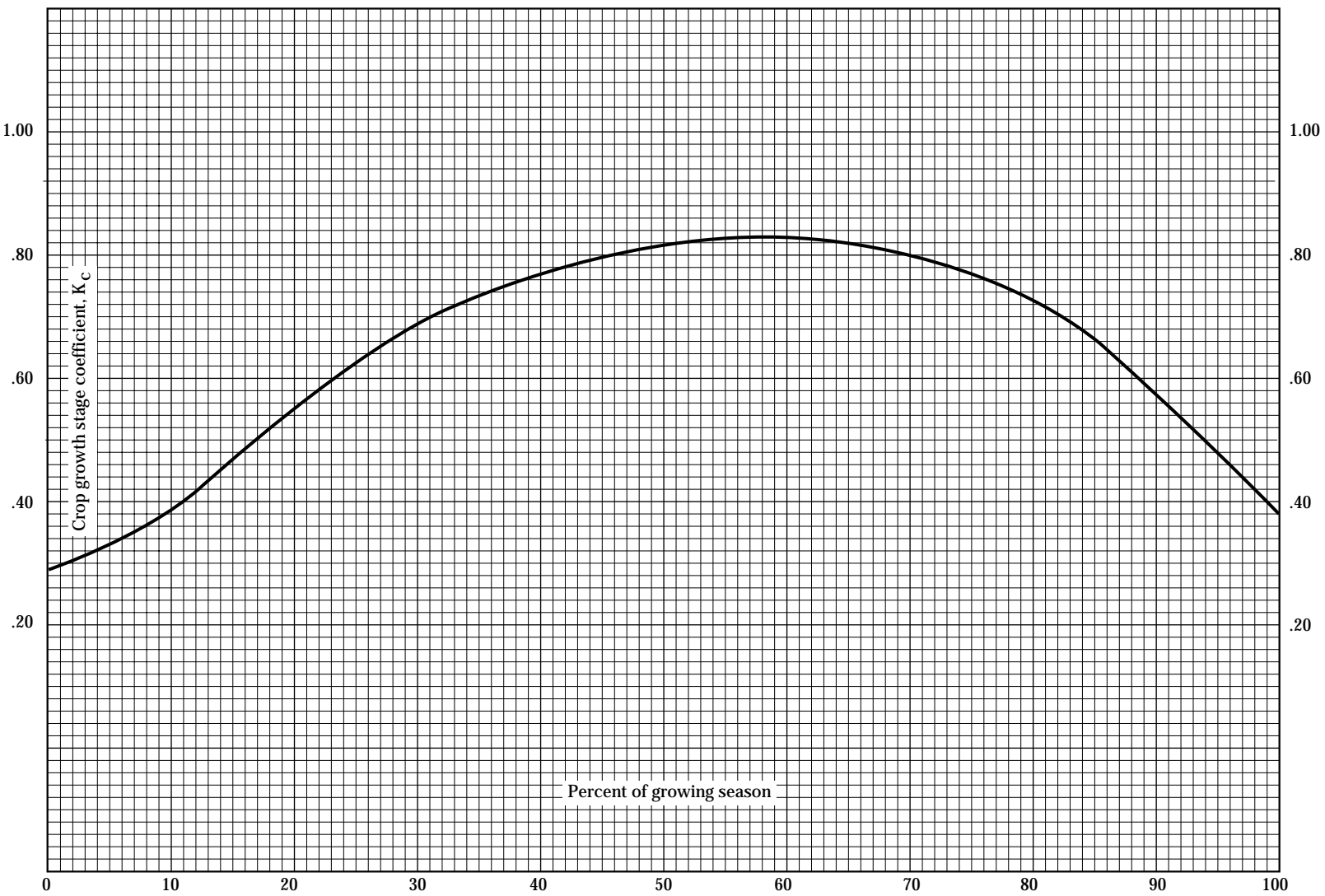

Figure 2A-22 Crop growth stage coefficient curve for walnuts

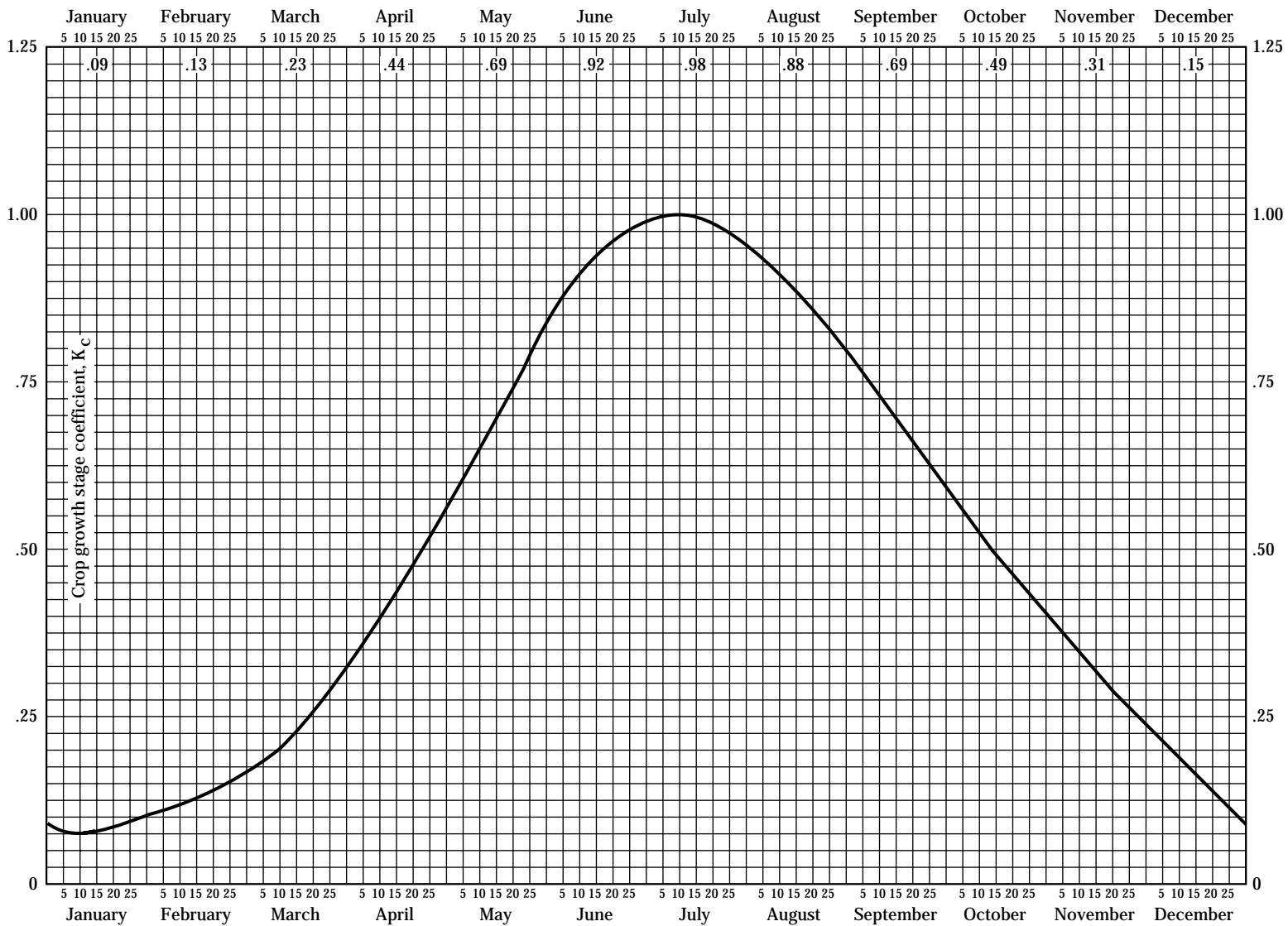
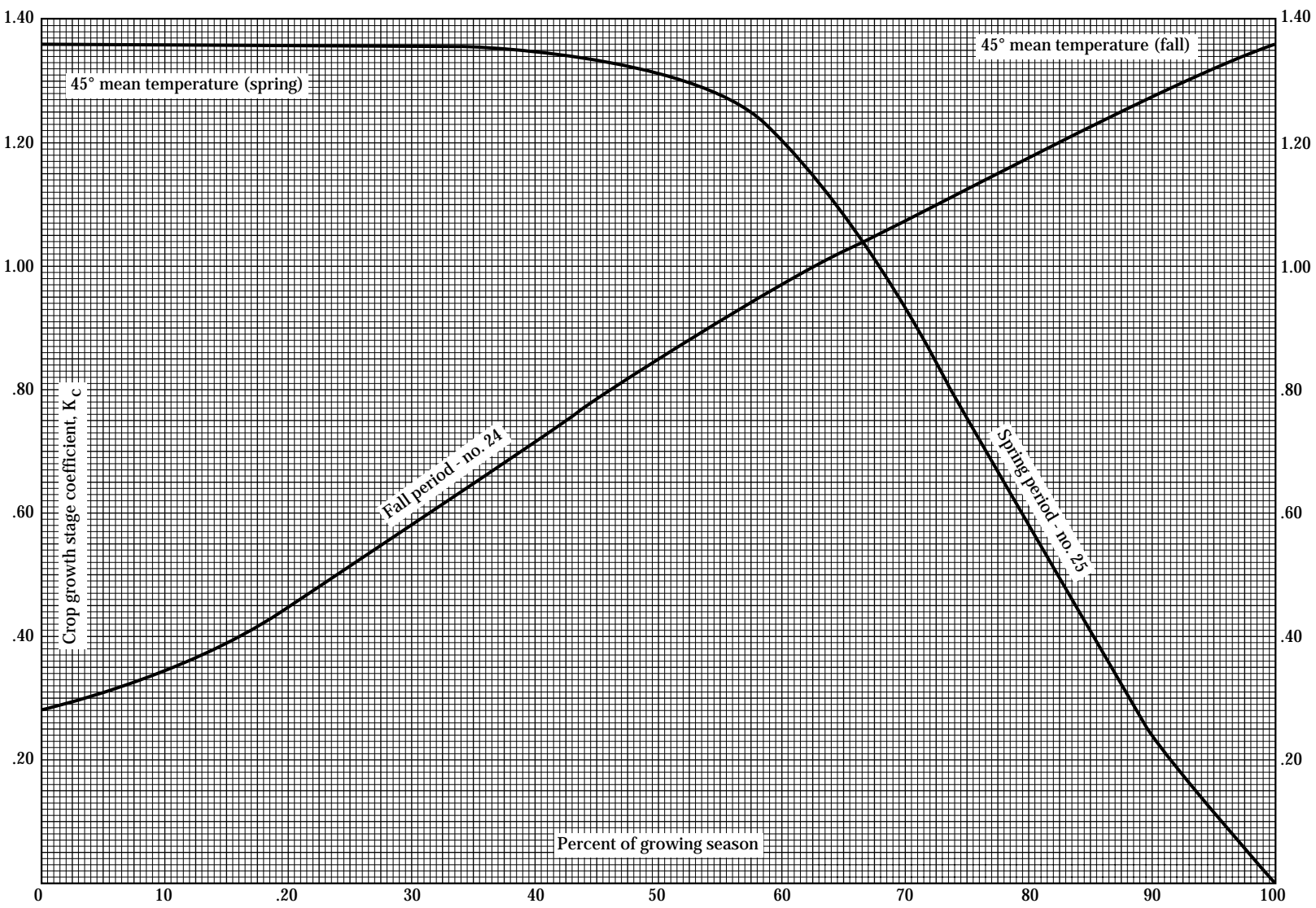

Figure 2A-23 Crop growth stage coefficient curve for winter wheat



Appendix B Day of Year Calendar

Day of month	Jan	Feb	Mar	Apr	May	Jun	Jul	Aug	Sep	Oct	Nov	Dec
1	1	32	60	91	121	152	182	213	244	274	305	335
2	2	33	61	92	122	153	183	214	245	275	306	336
3	3	34	62	93	123	154	184	215	246	276	307	337
4	4	35	63	94	124	155	185	216	247	277	308	338
5	5	36	64	95	125	156	186	217	248	278	309	339
6	6	37	65	96	126	157	187	218	249	279	310	340
7	7	38	66	97	127	158	188	219	250	280	311	341
8	8	39	67	98	128	159	189	220	251	281	312	342
9	9	40	68	99	129	160	190	221	252	282	313	343
10	10	41	69	100	130	161	191	222	253	283	314	344
11	11	42	70	101	131	162	192	223	254	284	315	345
12	12	43	71	102	132	163	193	224	255	285	316	346
13	13	44	72	103	133	164	194	225	256	286	317	347
14	14	45	73	104	134	165	195	226	257	287	318	348
15	15	46	74	105	135	166	196	227	258	288	319	349
16	16	47	75	106	136	167	197	228	259	289	320	350
17	17	48	76	107	137	168	198	229	260	290	321	351
18	18	49	77	108	138	169	199	230	261	291	322	352
19	19	50	78	109	139	170	200	231	262	292	323	353
20	20	51	79	110	140	171	201	232	263	293	324	354
21	21	52	80	111	141	172	202	233	264	294	325	355
22	22	53	81	112	142	173	203	234	265	295	326	356
23	23	54	82	113	143	174	204	235	266	296	327	357
24	24	55	83	114	144	175	205	236	267	297	328	358
25	25	56	84	115	145	176	206	237	268	298	329	359
26	26	57	85	116	146	177	207	238	269	299	330	360
27	27	58	86	117	147	178	208	239	270	300	331	361
28	28	59	87	118	148	179	209	240	271	301	332	362
29	29		88	119	149	180	210	241	272	302	333	363
30	30		89	120	150	181	211	242	273	303	334	364
31	31		90		151		212	243		304		365

References

- Allen, R.G. 1986. A Penman for all seasons. *J. Irrig. and Drain. Eng.*, Amer. Soc. Civil Eng. 112(4):348-368.
- Allen, R.G., C.E. Brockway, and J.L. Wright. 1983. Weather station siting and consumptive use estimates. *J. Water Resour., Plann. and Manage. Div.*, Amer. Soc. Civil Eng. 109(2):134-146.
- Allen, R.G., T.A. Howell, W.O. Pruitt, I.A. Walte and M.E. Jensen. 1991. Lysimeters for evapotranspiration and environmental measurements. *Proc. of the Int. Proc. on Lysimetry*, Amer. Soc. Civil Eng. Honolulu, HI, July 23-25.
- American Society of Civil Engineers. 1990. Agricultural salinity assessment and management. K.J. Tanji (ed). *Man. and Rep. on Eng. Pract.* No. 71, New York, NY, 619 pp.
- Anat, A., H.D. Duke, and A.T. Corey. 1965. Steady upward flow from water tables. *CSU Hydrol. Paper No. 7*, CO State Univ., Ft. Collins.
- Ayers, R.S., and D.W. Westcot. 1985. Water quality for agriculture. *Food and Agric. Organ., Irrig. and Drain. Paper No. 29*, rev. 1, 174 pp.
- Barfield, B.J., K.B. Perry, J.D. Martsolf, and C.T. Morrow. 1990. Modifying the aerial environment. *In* Management of farm irrigation systems, G.J. Hoffman, T.A. Howell, and K.H. Solomon (eds), Amer. Soc. Agric. Eng. Monograph. St. Joseph, MI, pp. 827-869.
- Bergsrud, F.G., J.A. Wright, H.D. Werner, and G.J. Spoden. 1982. Irrigation system design capacities for west central Minnesota as related to the available water holding capacity and irrigation management. *Tech. Paper No. NCR 82-101*. Amer. Soc. Agric. Eng., St. Joseph, MI.
- Bernstein, L. 1964. Salt tolerance of plants. *U.S. Dep. Agric. Inf. Bull.* 283.
- Bernstein, L., M. Fireman, and R.C. Reeve. 1955. Control of salinity in the Imperial Valley, California. *U.S. Dep. Agric-Agric. Res. Serv.* 41-4, 16 pp.
- Bode, L.E., M.E. Gebhart, and C.L. Day. 1968. Spray-deposit patterns and droplet sizes obtained from nozzles used for low-volume applicators. *Transac. Amer. Soc. Agric. Eng.*, 11(6):754-756, 761.
- Bouwer, H. 1988. Surface water-groundwater relations for open channels. *In* Planning now for irrigation and drainage in the 21st Century, Proc. conf. by the Amer. Soc. Civil Eng., Lincoln, NE, July 18-21, pp 149-156.
- Bouwer, H., and R.D. Jackson. 1974. Determining soil properties. *In* Drainage for agriculture. Amer. Soc. Agron. Monog. No. 17, Madison, WI, pp. 611-672.
- Brakensiek, D.L., R.L. Engleman, and W.J. Rawls. 1981. Variation within texture classes of soil water parameters. *Transac. Amer. Soc. Agric. Eng.* 24(2):335-339.
- Bresler, E., and G.J. Hoffman. 1986. Irrigation management for soil salinity control: Theories and tests. *Soil Sci. Soc. Amer. J.* 50:1552-1560.
- Brooks, R.H., and A.T. Corey. 1964. Hydraulic properties of porous media. *CSU Hydrol. Paper No. 3*, CO State Univ., Ft. Collins.
- Buchleiter, G.W., and D.F. Heermann. 1987. System scheduling for large farming operations. Planning, operation, rehabilitation, and automation of irrigation delivery systems. *Proc. Amer. Soc. Civil Eng. symp.*, Portland, OR, July 28-30, pp. 45-56.
- Burman, R.D., J.L. Wright, and M.E. Jensen. 1975. Changes in climate and estimated evaporation across a large irrigated area in Idaho. *Tran. of the Amer. Soc. Agric. Eng.* 18(6):1089-1093.
- Campbell, G.S. 1977. An introduction to environmental biophysics. Springer-Verlag, Berlin and New York.
- Clemmens, A.J. 1986. Canal capacities for demand under surface irrigation. *J. Irrig. and Drain. Eng.*, Amer. Soc. Civil Eng. 112(4):331-347.

- Clemmens, A.J. 1987. Delivery system schedules and required capacities. Planning, operation, rehabilitation, and automation of irrigation delivery systems. Proc. Amer. Soc. Civil Eng. symp., Portland, OR, July 28-30, pp.18-34.
- Coelho, D.T., and R.F. Dale. 1980. An energy-crop variable and temperature factor for predicting corn growth and development: planting to silking. *Agron. J.* 72:503-510.
- Council for Agricultural Science and Technology (CAST). 1988. Effective use of water in irrigated agriculture. Rep. No. 113, Ames, IA.
- Cross, H.Z., and M.S. Zuber. 1972. Prediction of flowering dates in maize based on different methods of estimating thermal units. *Agronomy Journal* 64:351-355.
- Dastane, N.G. 1974. Effective rainfall in irrigated agriculture. Food and Agric. Organ. of the United Nations Irrig. and Drain. Paper No. 25, 62 pp.
- Davies, D.L., R.G. Evans, G.S. Campbell, and M.W. Kroeger. 1988. Undertree sprinkling for low temperature modification in apple orchards. *Transac. Amer. Soc. Agric. Eng.*, 31(3):789-803.
- Doerge, T.A., R.L. Roth, and B.R. Bander. 1991. Nitrogen management in Arizona. Univ. AZ, Coll. Agric.
- Dong, A., S.R. Grattan, J.J. Carroll, and C.R.K. Prashar. 1992. Estimation of daytime net radiation over well-watered grass. *J Irrig and Drain Eng, Amer. Soc. Civil Eng.* 118(3):466-479.
- Doorenbos, J., and W.O. Pruitt. 1977. Guidelines for predicting crop water requirements. Irrig. and Drain. Paper No. 24, 2nd edition, Food and Agric. Organ. of the United Nations, Rome, Italy, 156 pp.
- Dvoracek, M.J., and B. Hannabas. 1990. Prediction of albedo for use in evapotranspiration and irrigation scheduling. *In Visions of the future. Proc. Third Natl. Irrig. Symp.* 692-699. Amer. Soc. Agric. Eng. Pub. 04-90, St. Joseph, MI.
- Frevert, D.K., and R.W. Ribbens. 1988. Methods of evaluating canal transmission losses. *In Planning now for irrigation and irainage in the 21st Century, Proc. conf. by the Amer. Soc. Civil Eng., Lincoln, NE, July 18-21, pp 157-164.*
- Gardner, H.R. 1983. Soil properties and efficient water use: Evaporation of water from bare soil. *In Limitations to efficient water use in crop production, Amer. Soc. Agron., Madison, WI, pp. 65-71.*
- Gerber, J.F., and D.S. Harrison. 1964. Sprinkler irrigation for cold protection of citrus. *Transac. Amer. Soc. Agric. Eng.*, 7(4):404-407.
- Gibbs, A.E. 1972. Current design capacity procedure used by the USBR. Changing priorities for land and water. Proc. Amer. Soc. Civil Eng. symp., Spokane, WA, Sept. 26-28, pp. 331-337.
- Hanks, R.J. 1974. Model for predicting plant yield as influenced by water use. *Agronomy Journal* 66:660-665.
- Hanway, J.J. 1971. How a corn plant develops. Coop. Ext. Serv. Rep. No. 48, Iowa State Univ., Ames, IA.
- Hatfield, J.L. 1983. Evaporation obtained from remote sensing methods. *In D. Hillel (ed), Advances in irrigation, vol. II, Academic Press, New York, NY, pp. 395-415.*
- Hedlund, J.D., and P.K. Koluvek. 1985. Rating systems to evaluate on-farm water conservation. Development and management aspects of irrigation and drainage systems. Proc. Amer. Soc. Civil Eng. symp., San Antonio, TX, July 17-19, pp. 137-145.
- Heermann, D.F., G.J. Harrington, and K.M. Stahl. 1985. Empirical estimation of clear sky solar radiation. *J Clim. and Appl. Meteorol.* 24(3):206-214.
- Heermann, D.F., H.H. Shull, and R.H. Mickelson. 1974. Center pivot design capacities in eastern Colorado. *J. Irrig. and Drain. Div., Amer. Soc. Civil Eng.* 100(IR2):127-141.
- Hiler, E.A., and R.N. Clark. 1971. Stress day index to characterize effects of water stress on crop yields. *Amer. Soc. Agric. Eng. Trans.* 14(4):757-761.

- Hill, R.W., E.L. Johns, and D.K. Frevert. 1983. Comparison of equations used for estimating agricultural crop evapotranspiration with field research. USDI, Bur. Reclam., 242 p.
- Hobbs, E.H. 1972. Crop cooling with sprinklers. *Canada Agric. Eng.*, 15(1):6-8.
- Hoffman, G.J. 1981. Irrigation management—Salinity control. Proc. Sec. Natl. Irrig. Symp., Amer. Soc. Agric. Eng., St. Joseph, MI, pp. 166-174.
- Hoffman, G.J. 1986. Yields of irrigated crops under saline conditions. Proc. Decision criteria for residuals management in agriculture. Sacramento, CA, pp. 107-145.
- Hoffman, G.J. 1990. Leaching fraction and root zone salinity control. *In* Agricultural salinity assessment and management, Amer. Soc. Agric. Eng. Man. & Rep. No. 71, pp. 235-261.
- Hoffman, G.J., and M. Th. van Genuchten. 1983. Water management for salinity control. *In* Limitations to efficient water use in crop production, H.M. Taylor, W. Jordan, and T. Sinclair (eds.), Amer. Soc. Agron., pp. 73-85.
- Hoffman, G.J., J.D. Rhoades, J. Letey, and F. Sheng. 1990. Salinity management. *In* Management of farm irrigation systems, G.J. Hoffman, T.A. Howell, and K.H. Solomon (eds.), Monog, Amer. Soc. Agric. Eng., St. Joseph, MI, pp. 667-715.
- Hotes, F.L., E.G. Kruse, J.N. Christopher, S. Niaz, and A.R. Robinson. 1985. Irrigation canal seepage and its measurement, a state-of-the-art review. *In* Develop. and manag. aspects on irrig. and drain. Sys., Proc., spec. conf., Amer. Soc. Civil Eng., San Antonio, TX, July 17-19, pp. 93-105.
- Howell, T.A., D.A. Bucks, D.A. Goldhamer, and J.M. Lima. 1986. Trickle irrigation for crop production. Develop. in Agric. Eng. 9. Elsevier, NY, pp. 241-279.
- Howell, T.A., D.A. Bucks, D.A. Goldhammer, and J.M. Lima. 1986. Irrigation scheduling. *In* F.S. Nakayama and D.A. Bucks (eds), Trickle irrigation for crop production: Design, operation, and management, ch. 4.1. Amer. Soc. Agric. Eng., St. Joseph, MI.
- Howell, T.A., K.S. Copeland, A.D. Schneider, and D.A. Dusek. 1989. Sprinkler irrigation management for corn—Southern Great Plains. *Amer. Soc. Agric. Eng. Trans.* 31(2):147-160.
- Hsaio, T.C., and D.W. Henderson. 1985. Improvement of crop coefficient for evapotranspiration. *In* Final report of California irrigation management information system. Land, air, and water resource, paper 10013-C, vol. II:3-32.
- Jackson, R.D. 1982. Canopy temperature and crop water stress. *In* Advances in irrigation, D. Hillel (ed.). Academic Press, New York, NY 1:43-85.
- James, J.G., J.M. Erpenbeck, D.L. Bassett, and J.E. Middleton. 1982. Irrigation requirements for Washington—Estimates and methodology. Res. Bul. XB 0925, Agric. Res. Cent., Washington State Univ., Pullman, WA, 37 pp.
- James, L.G. 1988. Principles of irrigation system design. John Wiley and Sons, Inc., New York, NY.
- Jensen, M.E. 1975. Scientific irrigation scheduling for salinity control of irrigation return flows. U.S. Environ. Prot. Agency Tech. Serv. Rep. 600/2-75-064, 100 p.
- Jensen, M.E. and J.L. Wright. 1978. The role of evapotranspiration models in irrigation scheduling. *Transactions of the ASAE* 21(1):82-87.
- Jensen, M.E., J.L. Wright, and B.J. Pratt. 1971. Estimating soil moisture depletion from climate crop and soil data. *Amer. Soc. Agric. Eng. Trans.* 14(5):954-959.
- Jensen, M.E., R.D. Burman, and R.G. Allen. 1990. Evapotranspiration and irrigation water requirements. Amer. Soc. Civil Eng. Man. and Rep. on Eng. Prac. No. 70, New York, NY.
- Jones, J.W., L.H. Allen, S.F. Shih, J.S. Rogers, L.C. Hammond, A.G. Smajstrala, and J.D. Martsolf. 1984. Estimated and measured evapotranspiration for Florida climate, crops, and soils. *Agr. Exp. Sta. Res. Bul. No. 840*, Univ. FL, 65 pp.

- Lundstrom, D.R., and E.C. Stegman. 1988. Irrigation scheduling by the checkbook method. Ext. Cir. No. AE-792. ND State Univ. Ext. Serv., Fargo, ND.
- Maas, E.V. 1986. Salt tolerance of plants. *Applied Agric. Res.*, 1(1):12-26.
- Maas, E.V. 1990. Crop salt tolerance. *In* Agricultural salinity assessment and management, Amer. Soc. Civil Eng. Man. & Rep. No. 71, pp. 262-304.
- Maas, E.V., and G.J. Hoffman. 1977. Crop salt tolerance—Current assessment. *J. Irrig. & Drain. Div.*, Amer. Soc. Civil Eng., 103(IR2):115-134.
- Marek, T.H., A.D. Schneider, T.A. Howell, and L.L. Ebeling. 1988. Design and construction of large weighing monolithic lysimeters. *Trans. of the Amer. Soc. Agric. Eng.* 31(2):477-484.
- Martin, D.L., E.C. Stegman, and E. Fereres. 1990. Irrigation scheduling principles. *In* Hoffman, G.J., T.A. Howell, and K.H. Solomon (eds). *Irri. Mgt. Monog.*, Amer. Soc. Agric. Eng., St. Joseph, MI, pp. 155-202.
- Martin, D.L., J.R. Gilley, and W.C. Skaggs. 1991. Soil water balance and management. *In* Managing nitrogen for groundwater quality and farm profitability. Spec. Pub. Soil Sci. Soc. Amer., Madison, WI.
- Mederski, H.J., D.L. Jeffers, and D.B. Peters. 1973. Water and water relations. *In* Soybeans—Improvement, production, and uses, (B.E. Caldwell, ed), Agron. Monog 16, Amer. Soc. Agron., Madison, WI.
- Mederski, H.J., M.E. Miller, and C.R. Weaver. 1973. Accumulated heat units for classifying corn hybrid maturity. *Agronomy Journal* 65:743-747.
- Norman, J.M., and G.S. Campbell. 1982. Application of a plant-environment model to problems in irrigation. *In* D. Hillel (ed). *Advances in irrigation*, vol. II, Academic Press, New York, NY, pp. 155-187.
- Patwardhan, A.S., J.L. Nieber, and E.L. Johns. 1990. Evaluation of effective rainfall estimation methods. *J. Irrig. and Drain.*, Amer. Soc. Civil Eng. 116(2):182-193.
- Perry, K.B., J.D. Martsolf, and C.T. Morrow. 1980. Conserving water in sprinkling for frost protection by intermittent application. *J. Amer. Soc. Hort. Sci.* 105:657-660.
- Phene, C.J., D.W. Meek, K.R. Davis, R.L. McCormick, and R.B. Hutmacher. 1985. Real-time crop evapotranspiration and determination of crop coefficients. *In* Proceedings of the national conference on advances in evapotranspiration. Pub. 14-85, Ameri. Soc. Agric. Eng., St. Joseph, MI.
- Pleban, S., J.W. Labadie, and D.F. Heermann. 1983. Optimal short term irrigation schedules. *Amer. Soc. Agric. Eng. Trans.* 26(1):141-147.
- Raats, P.A.C., and W.R. Gardner. 1974. Movement of water in the unsaturated zone near a water table. *In* Drainage for agriculture, Amer. Soc. Agron. Monog. No. 17, Madison, WI. pp. 311-357.
- Reddell, D.L., J.F. Prochaska, and A.J. Cudrak. 1987. Sequential water stress in cotton: A stress day index model. Tech. Paper No. 87-2080. Amer. Soc. Agric. Eng., St. Joseph, MI.
- Replogle, J.A., A.J. Clemmens, and M.G. Bos. 1991. Flow measuring flumes for open channel systems. *Amer. Soc. Agric. Eng.*, St. Joseph, MI.
- Replogle, J.A., and M.G. Bos. 1982. Flow measurement flumes: Applications to irrigation water management. *In* D. Hillel (ed), *Advances in irrigation*, Academic Press, New York, NY, 1:147-217.
- Rhoades, J.D. 1974. Drainage for salinity control. *In* J. van Schilfgaarde (ed.), *Drainage for agriculture*, Agron. Mono. No. 17: 333-361.
- Rhoades, J.D. 1982. Reclamation and management of salt-affected soils after drainage. *In* Proc. first ann. western provincial conf. Ration. Water Soil Res. Manage., Lethbridge, Alberta, Canada, pp. 123-197.
- Rhoades, J.D. 1990. Blending saline and non-saline waters reduces water usable for crop production. *In* Proc. 1990 Natl. Conf., Irrig. & Drain. Div. of Amer. Soc. Civil Eng., pp. 442-452.

- Rhoades, J.D., and J. Loveday. 1990. Salinity in irrigated agriculture. *In* Irrigation of agricultural crops, Agron. Monogr. No. 30., pp. 1089-1142.
- Ritchie, J.T. 1972. Model for predicting evaporation from a row crop with incomplete cover. *Water Resour. Res.* 8:1204-1213.
- Ritchie, J.T. 1973. Influence of soil water status and meteorological conditions on evaporation from a corn canopy. *Agron. J.* 65:893-897.
- Ritchie, S.W., and J.J. Hanway. 1982. How a corn plant develops. *Coop. Ext. Serv. Spec. Rep. No. 48*, Iowa State Univ., Ames, IA.
- Ritchie, S.W., J.J. Hanway, and H.E. Thompson. 1982. How a soybean plant develops. *Ext. Serv. Rep. No. 53*. Iowa State Univ., Ames, IA.
- Rosenberg, N.J. 1974. *Microclimate: The biological environment*. John Wiley and Sons, Inc. New York, NY.
- Seymour, V.A., and T.C. Hsiao. 1984. A soil surface psychrometer for measuring humidity and studying evaporation. *Agric. and For. Meteorol.* 32:61-70.
- Shani, U., R.J. Hanks, E. Bresler, and C.A. Oliveira. 1987. Estimating hydraulic conductivity and matric potential-water content relations. *Soil Sc. Soc. Amer. J.* 51:298-302.
- Skaggs, R.W. 1981. Water movement factors important to the design and operation of subirrigation systems. *Transac. Amer. Soc. Agric. Eng.* 24(6):1553-1561.
- Snyder, R.L., B.J. Lanini, D.A. Shaw, and W.O. Pruitt. 1987. Using reference evapotranspiration and crop coefficients to estimate crop evapotranspiration for trees and vines. *Coop. Ext., Univ. CA., Div. Agricul. and Natural Resourc. Leaf. 21428*, Berkeley, CA.
- Stanley, R.G., and W.L. Butler. 1961. Life processes of the living seed. *In* *Seed*, USDA Year Book, U.S. Govt. Print. Off., Washington, DC.
- Stegman, E.C. 1988. Corn crop curve comparisons for the Central and Northern Plains of the U.S. *Appl. Eng. in Agric., Amer. Soc. Agric. Eng.* 4(3):226-233.
- Thompson, A.L., J.R. Gilley, and J.M. Norman. 1988. Modeling water losses during sprinkler irrigation. Unpub. Paper No. 88-2130, presented at the summer meeting, Amer. Soc. Agric. Eng., Rapid City, SD, 15 pp.
- Threadgill, E.D., D.E. Eisenhauer, J.R. Young, and B. Bar-Yosef. 1990. Chemigation. *In* *Management of farm irrigation systems*. G.J. Hoffman, T.A. Howell, and K.H. Solomon (eds), Amer. Soc. Agric. Eng. Monog., St. Joseph, MI. pp. 749-780.
- Trava, J., D.F. Heermann, and J.W. Labadie. 1977. Optimal on-farm allocation of irrigation water. *Amer. Soc. Agric. Eng. Trans.* 20(1):85-88, 95.
- United States Department of Agriculture, Agricultural Research Service. 1970. Irrigation water requirements. *Tech. Rel. No. 21*. (Rev. 2).
- United States Department of Agriculture, Soil Conservation Service. 1970. Irrigation water requirements. *Tech. Rel. No. 21*, (rev. 1970) 88 pp.
- United States Department of Agriculture, Soil Conservation Service. 1985. *Washington State Irrigation Guide (WAIG)*, Part WA-686, Farm distribution systems.
- United States Department of Agriculture, Soil Conservation Service. 1985. *Washington State SCS irrigation guide*. Part WA685, Irrigation method and design criteria with reference, Subpart L: Frost protection.
- United States Department of Agriculture, Soil Conservation Service. 1991. *Farm irrigation rating index (FIRI)*. A method for planning, evaluating, and improving irrigation management. SCS West NTC, Portland, OR.
- United States Department of Agriculture, U.S. Salinity Laboratory Staff. 1954. *Diagnosis and improvement of saline and alkali soils*. USDA Agric. Handb. No. 60, U.S. Gov. Print. Office. Washington, DC, 160 pp.

- United States Department of Agriculture. 1983. DRAINMOD User's Model. Interim Tech. Rel., Soil Conservation Service, Washington, DC.
- United States Department of Commerce. 1977. Climatic atlas of the United States. Natl. Oceanic and Atmos. Adm., Asheville, NC.
- van Schilfgaarde, J., L. Bernstein, J.D. Rhoades, and S.L. Rawlins. 1974. Irrigation management for salt control. J. Irrig. & Drain. Div., Amer. Soc. Civil Eng., 100 (IR3):321-338.
- Vanderlip, R.L. 1972. How a sorghum plant develops. Coop. Ext. Serv., Kansas State Univ., Manhattan, KS.
- von Bernuth, R.D., D.L. Martin, J.R. Gilley, and D.G. Watts. 1984. Irrigation system capacities for corn production in Nebraska. Amer. Soc. Agric. Eng. 27(2):419-424.
- Walker, R.W. 1979. Explicit sprinkler irrigation uniformity: efficiency model. Amer. Soc. Civil Eng., vol. 105, no. IR2, pp.129-136.
- Wesseling, J. 1974. Crop growth and wet soils. *In* Drainage for Agriculture. Amer. Soc. Agron. Monogr No. 17, Madison, WI. pp. 7-37.
- Willardson, L.S., and R.J. Hanks. 1976. Irrigation management affecting quality and quantity of return flows. Environ. Prot. Agency Tech. Serv. Rep. 600/2-76-226, 191 pp.
- Wright, J.L. 1981. Crop coefficients for estimates of daily crop evapotranspiration. *In* Proceedings of the irrigation scheduling conference: Irrig. sched. for water and energy conserv. in the 80's. Amer. Soc. Agric. Eng., St. Joseph, MI, pp. 18-26.
- Wright, J.L. 1982. New evapotranspiration crop coefficients. J. Irrig. and Drain. Div. Proc., Amer. Soc. Civil Eng. 108(IR2):57-74.
- Yates, W.E. 1962. Spray pattern analysis and evaluation of deposits from agricultural aircraft. Transac. Amer. Soc. Agric. Eng. 5(1):49-53.
- Zimbelman, D.D. 1987. Planning, operation, rehabilitation, and automation of irrigation delivery systems. Proc. Amer. Soc. Civil Eng. symp., Portland, OR, July 28-30.

Glossary

Advection (A_d)	Transfer of heat from hot dry air to crop canopies causing an increase in evapotranspiration. Effects are accelerated under windy conditions.
Albedo (α)	The portion of incoming solar radiation that is reflected away from crop and soil surfaces.
Allowable depletion	The amount, or percentage, of available soil water that can be used from the crop root zone without causing plant water stresses that reduce yields.
Application efficiency (E_a)	The ratio of the average depth of irrigation water infiltrated and stored in the root zone to the average depth of irrigation of water applied, expressed as a percentage.
Application Efficiency Low Half (AELH)	The ratio of the average of the low one-half of measurements of irrigation water infiltrated to the average depth of irrigation water infiltrated, expressed as a percentage.
Application Efficiency Low Quarter (AELQ)	The ratio of the average of the lowest one-fourth of measurements of irrigation water infiltrated to the average depth of irrigation water infiltrated, expressed as a percentage.
Average crop coefficient (K_a)	A crop coefficient used to compute evapotranspiration for a period of time where average conditions are used to account for the effect of water stress and evaporation from wet soil surfaces.
Barometric pressure (BP)	The air pressure due to the weight of the earth's atmosphere.
Basal crop coefficient (K_{cb})	A coefficient used to relate the evapotranspiration from a crop, that is not stressed for water and where the soil surfaces are dry, to that of a grass reference crop.
Bowen ratio (β)	The ratio of the amount of energy used to heat air to the amount of energy used to evaporate water.
Carryover soil moisture	Moisture stored in soils within crop root zone depths during the non-growing season, at times when the crop is dormant, or before the crop is planted. This moisture is available to help meet the consumptive water needs of the crop.
Chemigation	Application of chemicals to crops through an irrigation system by mixing them with the irrigation water.
Chlorosis	The yellowing or bleaching of the green portion of the plant, particularly the leaves. May be caused by disease organisms, nutrient deficiencies, excess water, or other factors, such as low temperature.
Clear sky solar radiation (R_{so})	The amount of solar radiation that would be received on a cloud free day.
Coefficient of uniformity (CU)	Christiansens Uniformity. A measure of uniformity of water application across a field or irrigation set.

Combination method	One of several forms of methods that use air temperature, relative humidity, solar radiation, and wind speed to predict the evapotranspiration from a reference crop. It is called a combination method because it combines the solar energy with that from advection.
Conveyance efficiency (E_c)	The ratio of the water delivered to the total water diverted or pumped into an open channel or pipeline at the upstream end, expressed as a percentage.
Crop coefficient (K_c)	The coefficient used to relate crop water use to that for a grass reference crop, or the ratio of crop ET to reference crop ET.
Crop growth stages (S_g)	Indices used to quantify the phenological development of crops.
Crop water use (ET_c)	The rate of evapotranspiration by a disease-free crop growing in a large field under nearly optimal agronomic conditions including adequate fertilizer, optimum water availability, plant density and weed control.
Cycle time	The time required to apply an irrigation to the entire field.
Demand delivery system	An irrigation water delivery system where the irrigator can order the rate and duration of water supply for the irrigated field.
Density (ρ)	The mass of a quantity per unit volume of the quantity.
Dew point temperature (T_d)	The air temperature where water vapor condenses from the air and forms dew.
Distribution uniformity	The measure of the uniformity of irrigation water distribution over a field.
Distribution Uniformity (DU) of low one-quarter	The ratio of the average of the lowest one-fourth of measurements of irrigation water infiltrated to the average depth of irrigation water infiltrated, expressed as a percentage.
Earliest irrigation date	The earliest time that a field can be irrigated without causing deep percolation at either the first or the last part of the field to be irrigated.
Effective cover date	The time during the growing season when the crop develops enough canopy to fully shade the ground surface so that the ET rate reaches the maximum rate possible for that crop in the existing environmental conditions.
Effective precipitation (P_e)	Precipitation falling during the growing period of the crop that is available to meet the consumptive water requirements of crops. It does not include precipitation that is lost to deep percolation below the root zone, surface runoff, or evaporation from soil surface.
Electrical conductivity (EC)	The property of a substance to transfer an electrical charge (reciprocal of resistance). Used for the measurement of the salt content of an extract from a soil when saturated with water, measured in mmho/cm or dS/m. EC_e of the saturation paste at 77 °F (25 °C).

Electrical conductivity of irrigation water (EC_i)	The electrical conductivity of the irrigation water.
Electrical conductivity of applied water (EC_{aw})	The electrical conductivity of the applied water; irrigation water, plus precipitation.
Emittance (ϵ)	The amount of longwave radiation given off by an objective, compared to the theoretical amount of longwave radiation that a perfect body would emit.
Evaporation pan	A small pan (48 inch diameter x 10 inches deep) used to estimate the reference crop evapotranspiration rate. Water levels are measured daily in the pan to determine the amount of evaporation.
Evapotranspiration (ET)	The volume of water used as evaporation from soil surfaces plus transpiration from plants.
Exchangeable sodium percentage (ESP)	The degree of saturation of the soil exchange complex with sodium; it may be calculated by the formula: $ESP = \frac{\text{exchangeable sodium (meq / 100 g soil)}}{\text{cation exchange capacity (meq / 100 g soil)}}$
FAO Blaney-Criddle Method	A method that uses air temperature data and long-term records for other parameters to predict the evapotranspiration from a grass reference crop.
Fertigation	The application of fertilizer to the field by mixing the fertilizer with the water applied by the irrigation system.
Flexibility factor	A factor used in sizing irrigation projects that is used to provide management flexibility by increasing the capacity of the system beyond that required to only meet crop needs.
Fraction of growing season (F_g)	The amount of time that has elapsed since planting, or early growth, relative to the amount of time between planting and physiological maturity or dormancy.
Freeze protection	The use of irrigation to prevent crops from injury when the ambient air temperature drops below a critical level where damage occurs.
Frost protection	The use of irrigation to prevent crops from injury on clear, calm, cool nights when radiation from the crop would cool plants below a critical temperature where damage occurs.
Gross irrigation water requirement (F_g)	The net irrigation water requirement divided by the irrigation efficiency. Sometimes called irrigation requirement.
Gross system capacity (C_g)	The volume flow rate per unit land area (gallons per minute per acre) that the irrigation system is capable of supplying if it operates continuously.

Growing degree days (GDD)	A temperature based system to describe the rate of plant growth. The growing degree day equals the difference in average daily air temperature and some base temperature where growth begins. The average air temperature is often limited by a maximum and minimum temperature.
Heat of vaporization (λ)	The amount of energy required to evaporate a unit of water.
Irrigation scheduling	A process that is repetitively used during the growing season to decide when to irrigate and how much water to apply.
Irrigation efficiency (E_i)	The ratio of the average depth of irrigation water that is beneficially used to the average depth of irrigation water applied, expressed as a percentage.
Irrigation water management	Managing water, soil, and plant resources to optimize precipitation and applied irrigation water according to plant water needs. This includes: <ul style="list-style-type: none">• Applying the correct amount of water at the proper time (irrigation scheduling) without significant soil erosion and translocation of applied water• Applying the predetermined amount of water (includes measurement)• Adjusting irrigation system operations to maximize irrigation application uniformity• Performing necessary irrigation system maintenance
Irrigation water requirement	The quantity, or depth, of water in addition to precipitation, required to obtain desired crop yield and to maintain a salt balance in the root zone.
Langley	The amount of energy (calories) received on a unit surface area (cm^2). This unit is commonly used for recording the amount of solar radiation received on a daily basis.
Latest irrigation date	The latest date an irrigation can be started on a field to ensure that the soil water does not drop below the allowable depletion any where in the field before the irrigation is completed.
Leaching	The process of water movement through and below the crop root zone by gravitation. It occurs whenever the infiltrated irrigation water and rainfall exceed ET_c and the water storage capacity of the soil profile.
Leaching fraction (L_f)	That portion of the irrigation water and precipitation entering the soil that effectively flows through and below the crop root zone.
Leaching requirement (L_r)	That part of the irrigation water and precipitation entering the soil that effectively must flow through and below the crop root zone to prevent the buildup of salinity within the crop root zone. Minimum leaching fraction needed to prevent yield reduction.
Leaf Area Index (LAI)	The ratio of the amount of leaf area of a crop stand relative to the amount of land area underlying that crop.
Localized irrigation	Irrigation systems which wet, in particular, the area of soil at the base of the plant. Encompassing term used to describe other irrigation systems such as: trickle, drip, drop, daily flow, micro.

Log-normal distribution	A statistical distribution where the logarithms of data are normally distributed. The distribution is used to represent data that are positive and where values smaller than the mean occur more frequently than values bigger than the mean.
Longwave radiation	Radiation that is due to the temperature differences between two objects. It occurs in the wavelength band between 3 to 70 microns.
Lysimeters	Devices used to directly measure the rate of water use by crops. Usually a box is filled with soil and placed in the field. Plants are grown in the box. The change in water content in the box is monitored over time. The water loss is used to determine the evapotranspiration.
Management Allowed Depletion (MAD)	The desired soil water deficit, below field capacity, at the time of irrigation.
Moisture retention curve	The relationship between the amount of water remaining in the soil at equilibrium as a function of the matric potential. It is also known as soil-moisture characteristic curve.
Net irrigation requirement (F_n)	The depth of irrigation water, exclusive of effective precipitation, stored soil moisture, or ground water that is required for meeting crop evapotranspiration for crop production and other related uses. Such uses may include water required for leaching, frost protection.
Net outgoing longwave radiation (R_b)	The longwave radiation that is lost from the crop and soil system to the atmosphere.
Net radiation (R_n)	The radiant energy available for crop ET. It is the portion of the intercepted incoming solar radiation minus the net outgoing longwave radiation.
Net system capacity (C_n)	The volume flow rate per unit land area (gallons per minute per acre) required to supply water fast enough to satisfy crop water use without unintentional stress.
Osmotic effect	The force a plant must exert to extract water from the soil. The presence of salt in the soil-water increases the force the plant must exert.
Osmotic potential	The additional energy required to extract and absorb water from a salty soil.
Pan coefficient (k_p)	A coefficient used to relate the rate of evaporation from an evaporation pan to the evapotranspiration for a grass reference crop.
Peak ET	The maximum ET rate during the growing season. This rate is commonly used to design irrigation systems.
Penman-Monteith method	A method used to predict the reference crop evapotranspiration using climatic data for: air temperature, relative humidity, wind speed, and solar radiation.

Percent downtime (D_t)	The fraction of the total possible operating time that the irrigation system is shutoff. Downtime may result from equipment breakdown, electrical load management, farming needs, or other factors.
Persistence factor (P_f)	A factor to represent the cumulative amount of evaporation from a wet soil following an irrigation or rain.
Psychrometric constant (γ)	The change in vapor pressure of the air when it is cooled from the ambient temperature to the wet bulb temperature without adding or removing energy.
Radiation based ET_o method	A method based primarily on radiation for predicting the evapotranspiration of a grass reference crop.
Reference crop evapotranspiration (ET_o)	The evapotranspiration from a thick, healthy, well maintained grass that does not suffer any water stress. The reference crop ET_o is used to represent the water use of a standard crop in that environment even though that crop may not be physically grown in the area.
Relative humidity (RH)	Ratio of the amount of water present in the air to the amount required for saturation of the air at the same dry bulb temperature and barometric pressure, expressed as a percentage.
Relative yield (Y_r)	The ratio of the actual yield relative to the maximum attainable yield if no water or salinity stress occurs.
Root zone	The area of the soil from which the crop roots extract water and nutrients.
Rotational area (A_r)	The area that can be irrigated with a water supply if the water supply is furnished continuously.
Rotational delivery systems	An irrigation water delivery system where water is furnished on a fixed cycle. An irrigator would receive water once during this cycle interval.
Salinity profile	The diagrammatic representation of zones of varying levels of salinity, as exposed in a cut section of a field.
Salt tolerance threshold	The electrical conductivity of the saturated-soil extract at which the yield of the respective crop begins to decline due to stress from salinity, expressed in mmho/cm.
Saturated vapor pressure (e^o)	The vapor pressure when the air is completely saturated with water vapor so that no further evaporation can occur.
Sodium Adsorption Ratio (SAR)	The ratio for soil extracts and irrigation water used to express the relative activity of sodium ions in exchange reactions with soil; expressed in meq/L.

$$SAR = \frac{Na}{\sqrt{\frac{(Ca + Mg)}{2}}}$$

Soil heat flux (G)	The transfer of energy from (or to) the plant canopy to (or from) the soil.
Soil solution	The aqueous solution existing in equilibrium with a soil at a particular soil water tension.
Soil-water balance	A procedure to record the additions and withdrawals of water from the crop root zone and to determine the amount of available water remaining in the root zone at a desired time.
Soil-water potential	The amount of work that must be done per unit quantity of pure water in order to transport reversibly and isothermally an infinitesimal quantity of water from a pool of pure water at a specified elevation, at atmospheric pressure, to the soil-water at the point under consideration. The total soil-water potential is the sum of gravitational, matric, and osmotic potentials.
Solar radiation (R_s)	Radiation from the sun that passes through the atmosphere and reaches the combined crop and soil surface. The energy is generally in a waveband width of 0.1 to 5 microns.
Specific heat (C_p)	The amount of energy required to raise the temperature of an object one degree.
Stress factor (K_s)	A factor used to modify the crop coefficient when water stress reduces the ability of the plant to transpire.
System capacity curve for conveyance systems	A curve used to show the required flow rate in a system as a function of the size of the area to be irrigated.
Vapor pressure (e)	The portion of the barometric pressure that is due to water vapor in the air.
Yield decline	The amount of yield reduction per unit increase of salinity of the saturated-soil extract, expressed as percent yield reduction per mmho/cm.
Weibull distribution	A statistical distribution used to represent data that are positive and that have a distribution that is skewed to the left of the mean value. The distribution is often used to evaluate the design probability for system capacity design.

Symbols

Symbols used for units:

ac	acres	hr	hours	mg	milligram
ft ³ /s	cubic feet per second	in	inches	mi	miles
cc	cubic centimeters	L	liters	min	minutes
cm	centimeters	lang	langley	mmho	millimhos
d	days	lb	pounds	mo	month
ds	decisiemens	m	meters	ppm	parts per million
ft	feet	mb	millibars	psi	pounds per square inch
g	grams	meq	milliequivalents	s	seconds
gpm	gallons per minute				

Symbol	Definition	Units
α	albedo of crop and soil surface	
α_d	distribution uniformity	%
β	Bowen ratio	
γ	psychrometric constant	mb/°F
γ^*	adjusted psychrometric constant = $\gamma (1 + r_c / r_a)$	
Δ	slope of the saturated vapor pressure curve	mb/°F
Δt	length of time in a period	hr or d
ΔT	air temperature reduction for crop cooling	°F
η	exponent in Brooks Corey hydraulic conductivity function	
θ_v	volumetric water content	%
θ_r	residual soil water content	%
θ_s	saturated volumetric water content	%
θ_m	solar altitude at solar noon	degrees
θ_d	solar declination angle	degrees
θ_{fc}	volumetric water content at field capacity	%
θ_{pwp}	volumetric water content at permanent wilting point	%
ϵ	atmospheric emittance	
λ	heat of vaporization	lang/in
λ_p	pore size distribution index	
ρ	density of air	lb/ft ³
ρ_b	soil bulk density.	lb/ft ³
ρ_s	specific gravity of soil particles (about 2.65)	
ρ_w	density of water equal to 62.4	lb/ft ³
σ	Stephan-Boltzman constant	
ϕ	soil porosity	
ϕ_e	effective porosity	
A	leading parameter of clear sky radiation equation	
a	empirical slope in longwave radiation equation	
a_1	factor to account for effect of day length on emissivity	
A_d	advection.	lang/d
A_f	average wet soil evaporation factor	
A_H	energy used to heat air.	lang/d
A_h	air heat flux.	lang/d
A_i	irrigated area	ac
AELH	application efficiency of low-half	%

AELQ	application efficiency of low-quarter	%
AR	advance ratio for surface irrigation	
ASW	percentage of total available soil water stored in root zone	%
ASW _c	critical value of ASW	%
A _t	rotational irrigated area	ac
AW	available soil water	in
AWC	available water content	%
a _t	intercept for FAO Blaney-Criddle ET _o method	
A _u	fraction of the field that is under irrigated	%
B	cosine coefficient in clear sky radiation equation	
b	empirical intercept for longwave radiation equation.	
b _n	parameter to compute value of b _r using n/N and RH _{min}	
BP	barometric pressure	mb
b _r	slope term in Radiation ET _o method	
b _t	slope for the FAO Blaney-Criddle ET _o method	
b _u	parameter to compute value of br using U _d and RH _{min}	
C ₁	coefficient to convert energy units into water use	
C _e	adjustment factor for the FAO Blaney-Criddle ET _o method	
C _f	farm capacity	gpm/ac or in/d
C _g	gross system capacity	gpm/ac or in/d
C _H	energy used to heat crop	lang/d
C _n	net system capacity	gpm/ac or in/d
c _p	specific heat of dry air	lang/in-°F
c _s	empirical specific heat coefficient for soil	lang/°F/d
CU	Christiansen's coefficient of uniformity	
CV	coefficient of variation	
d	zero plane displacement height	ft
D	usable soil water storage	in
D _a	depth of infiltrated water including irrigation and precipitation	in
D _d	depth of drainage water per unit land area.	in
DOY	day of the year (1-365)	
D _p	deep percolation	in
D _{pf}	deep percolation from irrigation	in
D _{pr}	deep percolation from rainfall	in
D _t	percent downtime	%
DU	distribution uniformity of an irrigation application	
d _w	distance from bottom of the root zone to water table	ft
e	actual vapor pressure.	mb
e ^o	saturated vapor pressure of air	
e ^o _{T_{maxz}}	saturated vapor pressure at maximum air temperature	mb
e ^o _{T_{minz}}	saturated vapor pressure at minimum air temperature	mb
e ^o _w	saturated vapor pressure at the wet bulb temperature	mb
e ^o _z	average saturated vapor pressure at height z above the soil surface	mb
e _d	saturated vapor pressure at dew point	
e _z	actual vapor pressure at height z above the soil surface	
E _a	application efficiency	%
E _b	on-farm canal conveyance efficiency	%
EC _d [*]	maximum value of electrical conductivity of the drainage water without reducing crop yield	mmho/cm
E _c	conveyance efficiency	%

EC_{aw}	electrical conductivity of the applied water	mmho/cm
EC_d	electrical conductivity of the drainage water	mmho/cm
EC_e	electrical conductivity of the saturated-soil extract	mmho/cm
EC_i	electrical conductivity of the irrigation water	mmho/cm
EC_t	electrical conductivity where yield reduction begins	mmho/cm
EC_y	electrical conductivity above which the yield is zero	mmho/cm
E_d	efficiency of the irrigation project distribution system	%
E_{et}	energy available for evapotranspiration	
E_f	combined on-farm conveyance and application efficiency	%
E_h	application efficiency of the low-half	%
E_i	irrigation efficiency	
E_l	net energy input	lang/d
E_{lev}	elevation above sea level	ft
E_{os}	average surface evaporation in the non-growing season	in
E_{pan}	evaporation from class A pan	in/d
E_q	application efficiency of the low-quarter	%
ESP	exchangable sodium percentage	%
ET	crop evapotranspiration during a period	in
ET_c	actual crop water use, or evapotranspiration	in or in/d
ET_d	average daily peak ET for the period analyzed	in/d
ET_m	peak monthly ET rate	in
ET_o	reference ET for 5 inch tall clipped grass	in/d
E_{ws}	total wet soil evaporation for a wetting event	in
EXP	exponential function	
EC_w	electrical conductivity of the water	mmho/cm
f	irrigation frequency	d^{-1}
f_p	interval between significant rains or irrigations	d
$f(t)$	wet soil surface evaporation decay function	
F	irrigation amount during a period	in
F_g	gross irrigation requirement	in
F'_g	gross irrigation requirement to meet the salinity requirement	in
F_i	irrigation depth that must infiltrate if all infiltrated precipitation contributes to crop evapotranspiration ..	in
F_n	net irrigation	in
F_{ro}	fraction of the gross irrigation that does not infiltrate	
F_S	fraction of growing season	
F_{S1}	fraction of growing season at end of initial crop growth stage	
F_{S2}	fraction of growing season at end of canopy development stage	
F_{S3}	fraction of growing season at end of mid-season growth stage	
F_w	fraction of the soil surface wetted	
G	soil heat flux.	lang/d
GDD	cumulative growing degree days after planting	
GDD_i	cumulative growing degree days on day i	$^{\circ}F$
GDD_m	cumulative growing degree days needed for maturity	$^{\circ}F$
GW	ground water contribution to ET during a period.	in
h	capillary pressure head	in
h_b	capillary pressure head at the bubbling pressure	
h_c	height of the crop	in
H_r	hours of water delivery per day	
h_w	height of ground cover at the weather station	in
I_f	intake family	

k	von Karman's constant 0.41	
k_p	pan coefficient.	
K	hydraulic conductivity	in/d
K_1	unit conversion constant for Penman-Monteith equation	
K_a	average crop coefficient	
K_c	crop coefficient	
K_{cb}	basal crop coefficient	
K_{cm}	value of basal crop coefficient at crop maturity	
K_{cp}	peak or maximum value of basal crop coefficient	
K_O	saturated conductivity	in/d
K_s	stress factor to reduce water use for stressed crops	
K_w	factor to account for increased evaporation from wet soils	
LAI	leaf area index	
Lat	latitude N	degrees
LN	natural logarithm	
LOG	base 10 logarithm	
L_f	leaching fraction for steady state conditions	
L_r	leaching requirement	
m	rank of an ET value (m=1 for the smallest value)	
M	month of the year (1 to 12).	
n	Mannings roughness coefficient	
n	number of years analyzed.	
n/N	ratio of actual (n) to maximum possible sunshine hrs (N)	
N_d	day of the month (1 to 31)	
p	monthly percent of annual daytime hours	%
pH	concentration of hydrogen ions	
P	precipitation or rainfall during a period	in
P_a	average annual precipitation	in
P_b	probability that ET_c will be less than a specified value	%
P_e	average monthly effective monthly precipitation	in
P_f	wet soil evaporation persistence factor	
P_{net}	net annual rainfall that contributes to leaching	in
P_s	energy used for photosynthesis	lang/d
P_t	total mean monthly precipitation	in
q	soil water flux (volume of water flow per unit area)	in/hr
q_r	relative rate of upward water flow	
q_u	rate of upward flow	in/d
Q	system capacity flow rate	ft ³ /s or gpm
Q_t	delivery flow rate	ft ³ /s
Q_{max}	maximum nonerosive furrow inflow	
r_a	aerodynamic resistance to sensible heat and vapor transfer	d/mi
r_c	surface resistance to vapor transport	d/mi
R_a	extraterrestrial radiation	lang/d
R_b	net outgoing longwave radiation	lang/d
R_{bo}	net outgoing longwave radiation on a clear day	lang/d
R_d	root zone depth	in
R_e	portion of applied water that reaches the soil or canopy	
R_f	surface runoff during the period	in
R_f	recurrence interval for soil surface wetting	d
RH	relative humidity	%
RH_a	long-term average relative humidity for a time period	%

RH_{\min}	mean minimum relative humidity	%
R_n	net radiation	lang/d
RO	runoff	in
RO_f	runoff from irrigation	in
RO_r	runoff from rainfall	in
R_r	reflected radiation	lang/d
R_s	incoming solar radiation	lang/d
R_{so}	amount of incident solar radiation on a clear day	lang/d
R_{sc}^e	clear sky radiation correction term for elevation	lang/d
R_{sc}^o	clear sky radiation at sea level	lang/d
SAR	sodium absorption ratio	
SD_L	Spray and drift losses from irrigation water in air and off plant canopies	in
S_e	effective saturation	
SF	soil water storage factor	
S_f	soil heat flux	lang/d
S_g	stage of crop growth.	
S_H	energy used to heat soil	lang/d
SIN	sine function expressed in degrees	
SMD	soil moisture deficit	in
S_o	field slope or grade	ft/ft
SP_a	average annual surface runoff from precipitation	in
SW	soil water in the crop root zone	in
SW_b	soil water in the root zone at the beginning of a period	in
SW_e	soil water in the root zone at the end of a period	in
ΔSW	change in soil water	in
T	mean air temperature for the period	$^{\circ}F$
t	elapsed time since wetting	d
T_a	average air temperature for the current day	$^{\circ}F$
T_{ai}	average air temperature on day i	$^{\circ}F$
TAW	total available water	in
T_{base}	base temperature at which photosynthesis and growth begins	$^{\circ}F$
t_d	time required for the soil surface to dry	d
T_d	dew point temperature	$^{\circ}F$
TDS	total dissolved solids	mg/L
t_i	duration of an individual irrigation	d
T_{\max}	daily maximum temperature	
$T_{\max k}$	maximum daily absolute air temperature	$^{\circ}K$
T_{\min}	daily minimum temperature	
$T_{\min k}$	minimum daily absolute air temperature	$^{\circ}K$
T_n	time required to infiltrate the net depth F_n	hr
T_p	mean air temperature for the preceding three days	$^{\circ}F$
T_s	effective absolute temperature of the earths surface	$^{\circ}K$
T_s^4	effective temperature of earth surface	
T_t	time required for water to advance across the field	hr
T_w	wet bulb temperature	$^{\circ}F$
U	wind velocity, or daily wind run	mi/hr or mi/d
U^*	representative friction velocity	
U_1	measured wind speed at height Z_1	mi/hr
U_2	estimated wind speed at height Z_2	mi/hr
U_{2m}	daily wind run at 2 meter height	mi/d

U_{3m}	daily wind run at 3 meter height	mi/d
U_c	wind speed at height Z over the reference crop.....	mi/d
U_d	daytime wind speed	mi/hr, mi/d
U_f	adjustment factor for wind speed	
U_r	ratio of daytime to nighttime wind speeds.	
U_w	wind speed	mi/d
U_z	daily wind run at height z	mi/d
W	Weibull transform of P_b	
W_u	average peak water use rate	gpm/ac
Y_d	relative yield decrease per unit of salinity increase	%/mmho/cm
Y_r	relative crop yield	
z	distance below the soil surface	
Z	height above the soil surface	ft
Z_o	roughness parameter	ft
Z_{om}	roughness length for momentum transfer.	ft
Z_{ov}	roughness length for vapor transfer	ft
Z_p	height of temperature and humidity probe	ft
Z_w	height of the anemometer at the weather station	ft

Index

A

Adequacy of irrigation 2-170
Advection 2-6, 2-7, 2-8, 2-38,
2-39, 2-40, 2-41, 2-267,
2-268, 2-275
Aerodynamic resistance 2-44,
2-46, 2-47, 2-278
Albedo 2-5, 2-6, 2-22, 2-23,
2-29, 2-267, 2-275
Application efficiency 2-116,
2-118, 2-125, 2-168, 2-169,
2-171, 2-172, 2-173, 2-174,
2-175, 2-178, 2-179, 2-180,
2-183, 2-187, 2-194, 2-195,
2-206, 2-214, 2-217, 2-218,
2-222, 2-267, 2-276
Application Efficiency Low Half
2-172, 2-173
Application Efficiency Low Quarter
2-168, 2-172, 2-173
Average crop coefficient 2-88,
2-89, 2-90, 2-91, 2-188,
2-267, 2-278

B

Barometric pressure 2-6, 2-13,
2-44, 2-182, 2-267, 2-272,
2-273, 2-276
Basal crop coefficient 2-67 -
2-80, 2-84, 2-85, 2-88, 2-89,
2-97, 2-187, 2-267, 2-278
Blaney-Criddle 2-12, 2-41, 2-42,
2-56, 2-57, 2-227, 2-230,
2-233, 2-269, 2-276
Bubbling pressure 2-155, 2-157,
2-161, 2-163, 2-277

C

Canopy resistance 2-46
Capillary pressure 2-155, 2-157,
2-162, 2-277
Chemigation 2-133, 2-139, 2-140,
2-267
Clear sky radiation 2-24, 2-25,
2-26, 2-27, 2-275
Coefficient of uniformity 2-139,
2-167, 2-168, 2-173, 2-174,
2-267, 2-276

Conveyance 2-4, 2-164, 2-165,
2-166, 2-181, 2-182, 2-183,
2-184, 2-185, 2-195, 2-196,
2-221, 2-222, 2-224, 2-225,
2-226, 2-268, 2-273, 2-276,
2-277
Conveyance efficiency 2-164,
2-181, 2-182, 2-183, 2-184,
2-195, 2-221, 2-222, 2-224,
2-268, 2-276
Critical temperature 2-133, 2-137,
2-269
Crop coefficient 2-3, 2-11, 2-12,
2-63, 2-65, 2-66, 2-67, 2-68,
2-69, 2-70, 2-71, 2-72, 2-73,
2-77, 2-78, 2-79, 2-80, 2-81,
2-84, 2-85, 2-87, 2-88, 2-89,
2-90, 2-91, 2-92, 2-97, 2-187,
2-188, 2-199, 2-227, 2-230,
2-267, 2-268, 2-273, 2-278
Crop cooling 2-164, 2-275
Crop evapotranspiration 2-1, 2-3,
2-7, 2-8, 2-9, 2-11, 2-13,
2-16, 2-17, 2-18, 2-41, 2-42,
2-48, 2-53, 2-63, 2-66, 2-69,
2-84, 2-85, 2-91, 2-97, 2-98,
2-115, 2-116, 2-125, 2-142,
2-144, 2-145, 2-147, 2-148,
2-155, 2-164, 2-187, 2-188,
2-192, 2-193, 2-199, 2-205,
2-209, 2-269, 2-271, 2-277
Crop salt tolerance 2-104, 2-115,
2-116, 2-123, 2-126
Cycle time 2-209, 2-212, 2-214,
2-268

D

Day of year 2-56, 2-259
Deep percolation 2-2, 2-8, 2-9,
2-119, 2-135, 2-142, 2-145,
2-146, 2-164, 2-165, 2-166,
2-169, 2-172, 2-181, 2-225,
2-268, 2-276
Delivery schedule 2-184, 2-185,
2-216, 2-217, 2-219, 2-220,
2-223, 2-224
Dew point 2-13, 2-14, 2-15,
2-16, 2-28, 2-30, 2-46, 2-133,
2-134, 2-268, 2-279

E

Effective cover date 2-66, 2-268
Effective precipitation 2-3, 2-119,
2-120, 2-142, 2-144, 2-145,
2-146, 2-147, 2-148, 2-149,
2-150, 2-152, 2-153, 2-154,
2-187, 2-189, 2-268, 2-271
Electrical conductivity 2-98,
2-101, 2-102, 2-104, 2-115,
2-116, 2-117, 2-119, 2-120,
2-190, 2-268, 2-269, 2-277
Elevation 2-9, 2-13, 2-18, 2-24,
2-25, 2-27, 2-45, 2-48, 2-56,
2-57, 2-125, 2-128, 2-157,
2-166, 2-167, 2-180, 2-273,
2-277, 2-279
Emittance 2-25, 2-28, 2-31,
2-269, 2-275
Erosion control 2-133, 2-138
Evaporation pan 2-39, 2-41, 2-43,
2-62, 2-63, 2-64, 2-65, 2-199,
2-269, 2-271
Evapotranspiration 2-1, 2-4 -
2-8, 2-11, 2-13, 2-16, 2-20,
2-34, 2-37, 2-38, 2-40, 2-41 -
2-44, 2-56, 2-62, 2-66, 2-68,
2-73, 2-82, 2-83, 2-84, 2-88,
2-91, 2-92, 2-97, 2-116,
2-118, 2-119, 2-123, 2-133,
2-142, 2-144, 2-145, 2-147 -
2-150, 2-155, 2-164, 2-187,
2-188, 2-192, 2-193, 2-197,
2-199, 2-202, 2-205, 2-220,
2-231, 2-261, 2-267, 2-268,
2-269, 2-271, 2-272, 2-277
Exchangeable sodium 2-99,
2-128, 2-131, 2-132, 2-269
Extraterrestrial radiation 2-5,
2-32, 2-33, 2-34, 2-278

F

Flexibility factor 2-220, 2-222,
2-224, 2-269
Fraction of growing season 2-71,
2-94, 2-96, 2-269, 2-277
Freeze protection 2-134, 2-269
Frost protection 2-133 - 2-137,
2-269, 2-271

- G**
- Gross irrigation 2-2, 2-116, 2-118, 2-119, 2-120, 2-122, 2-146, 2-189, 2-190, 2-193, 2-194, 2-209, 2-217, 2-218, 2-219, 2-269, 2-277
- Ground water 2-2, 2-8, 2-115, 2-123, 2-128, 2-140, 2-144, 2-146, 2-147, 2-166, 2-169, 2-170, 2-181, 2-187, 2-226, 2-227, 2-271, 2-277
- Growing degree days 2-68, 2-92, 2-93, 2-94, 2-95, 2-96, 2-270, 2-277
- H**
- Heat of vaporization 2-17, 2-44, 2-52, 2-270, 2-275
- Hydraulic conductivity 2-124, 2-128, 2-131, 2-132, 2-155, 2-157, 2-161, 2-163, 2-182, 2-275, 2-278
- I**
- Infiltration 2-98, 2-99, 2-100, 2-116, 2-128, 2-129, 2-132, 2-140, 2-142, 2-145, 2-146, 2-147, 2-165 - 2-169, 2-180
- Irrigation efficiency 2-3, 2-121, 2-164, 2-181, 2-194, 2-220, 2-269
- Irrigation scheduling 2-1, 2-2, 2-11, 2-12, 2-34, 2-43, 2-68, 2-69, 2-78, 2-92, 2-94, 2-116, 2-144, 2-146, 2-147, 2-164, 2-166, 2-168, 2-208, 2-209, 2-214, 2-215, 2-224, 2-270
- Irrigation water requirement 2-1, 2-3, 2-4, 2-66, 2-82, 2-97, 2-133, 2-142, 2-150, 2-154, 2-213, 2-216, 2-220, 2-224, 2-269, 2-270
- L**
- Latitude 2-5, 2-13, 2-22 - 2-26, 2-29, 2-32, 2-56, 2-57, 2-227, 2-228, 2-229, 2-233, 2-234, 2-278
- Leaching fraction 2-102, 2-105, 2-115, 2-116, 2-123, 2-142, 2-270
- Leaching requirement 2-3, 2-98, 2-101, 2-115, 2-116, 2-117, 2-118, 2-120, 2-121, 2-122, 2-124, 2-126, 2-133, 2-154, 2-190, 2-194, 2-225, 2-270, 2-278
- Log-normal 2-150, 2-198, 2-201, 2-202, 2-270
- Longwave radiation 2-6, 2-7, 2-22, 2-23, 2-24, 2-25, 2-28, 2-29, 2-31, 2-136, 2-269, 2-270, 2-271, 2-275
- Lysimeter 2-9, 2-10, 2-52, 2-271
- M**
- Management allowed depletion 2-2
- Moisture retention curve 2-271
- N**
- Net irrigation 2-8, 2-115, 2-116, 2-117, 2-144, 2-146, 2-148, 2-154, 2-187, 2-189, 2-200, 2-205, 2-208, 2-213, 2-220, 2-269, 2-271, 2-277
- Net radiation 2-6, 2-7, 2-8, 2-22, 2-28, 2-29, 2-34, 2-35, 2-44, 2-46, 2-271, 2-279
- P**
- Pan coefficient 2-62, 2-63, 2-64, 2-65, 2-199, 2-271, 2-278
- Peak ET 2-197, 2-198, 2-199, 2-202, 2-271, 2-277
- Penman-Monteith 2-41, 2-42, 2-43, 2-46, 2-48 - 2-51, 2-53, 2-64, 2-65, 2-78, 2-97, 2-271, 2-278
- Persistence factor 2-85, 2-86, 2-87, 2-271, 2-278
- Pore size distribution index 2-155, 2-157, 2-161, 2-275
- Precipitation 2-1, 2-2, 2-10, 2-115, 2-116, 2-119, 2-120, 2-123, 2-142, 2-143, 2-144, 2-146, 2-147, 2-148, 2-150, 2-152, 2-153, 2-187, 2-189, 2-225, 2-227, 2-268, 2-269, 2-270, 2-276, 2-277, 2-278
- Project water requirements 2-216
- Psychrometric 2-17, 2-44, 2-52, 2-272, 2-275
- R**
- Radiation method 2-41, 2-42, 2-43, 2-52, 2-53, 2-54, 2-57
- Reclamation 2-129, 2-131, 2-132, 2-220
- Reference crop 2-3, 2-11, 2-12, 2-13, 2-16, 2-22, 2-41, 2-46, 2-48, 2-52, 2-53, 2-62, 2-63, 2-66, 2-69, 2-73, 2-77 - 2-81, 2-84, 2-91, 2-97, 2-227, 2-267, 2-268, 2-269, 2-271, 2-272
- Relative crop yield 2-105, 2-280
- Relative humidity 2-6, 2-14, 2-15, 2-41, 2-43, 2-47, 2-52, 2-54, 2-56, 2-57, 2-62, 2-63, 2-70, 2-135, 2-136, 2-138, 2-144, 2-165, 2-231, 2-268, 2-271, 2-272, 2-278
- Rotational area 2-185, 2-218, 2-272
- Roughness 2-18, 2-44, 2-46, 2-144, 2-165, 2-175, 2-177, 2-280
- Runoff 2-2, 2-8, 2-9, 2-118, 2-119, 2-120, 2-124, 2-125, 2-129, 2-135, 2-138, 2-140, 2-142, 2-145, 2-146, 2-164, 2-165, 2-166, 2-168, 2-169, 2-171, 2-172, 2-173, 2-175, 2-177, 2-180, 2-190, 2-193, 2-194, 2-225, 2-268, 2-278, 2-279

S

Salinity 2-41, 2-98, 2-99 – 2-102, 2-104, 2-105, 2-110, 2-111, 2-115, 2-116, 2-117, 2-119, 2-120, 2-123 – 2-126, 2-128, 2-129, 2-133, 2-142, 2-155, 2-187, 2-192, 2-193, 2-226, 2-270, 2-272, 2-273, 2-280

Salinity control 2-98, 2-115, 2-120, 2-122, 2-125, 2-190, 2-191, 2-194

Salt balance 2-1, 2-115, 2-116, 2-119, 2-123, 2-270

Salt tolerance threshold 2-110, 2-116, 2-121, 2-190, 2-272

Saturated-soil extract 2-98, 2-99, 2-101, 2-104, 2-111, 2-115, 2-116, 2-272, 2-273, 2-277

Saturation 2-28, 2-102, 2-155, 2-162, 2-163, 2-268, 2-269, 2-272, 2-279

Seasonal irrigation requirement 2-119, 2-187, 2-188, 2-189, 2-190, 2-191, 2-193, 2-194, 2-208

Sodium Absorption Ratio 2-99, 2-279

Soil heat flux 2-7, 2-34, 2-36, 2-37, 2-44, 2-272, 2-277, 2-279

Soil water balance 2-1, 2-2, 2-8, 2-9, 2-146, 2-187, 2-194, 2-202, 2-207, 2-209, 2-264

Soil water potential 2-137, 2-155, 2-213

Solar radiation 2-5, 2-6, 2-22, 2-24, 2-32, 2-34, 2-41, 2-43, 2-46, 2-52, 2-267, 2-271, 2-273, 2-279

Specific ion effects 2-104, 2-111

Stage of growth 2-1, 2-66, 2-70, 2-94, 2-96, 2-144, 2-165, 2-232

Stress factor 2-68, 2-82, 2-84, 2-88, 2-213, 2-273, 2-278

Sunshine 2-13, 2-32, 2-56, 2-58, 2-59, 2-231, 2-278

System capacity 2-154, 2-194, 2-197, 2-202, 2-206 – 2-209, 2-214, 2-216, 2-218, 2-220 – 2-224, 2-269, 2-271, 2-273, 2-276

T

Total available water 2-2, 2-82, 2-84

U

Uniformity 2-123, 2-124, 2-135, 2-139, 2-140, 2-164 – 2-169, 2-171 – 2-174, 2-267, 2-268, 2-275, 2-276

Upward flow 2-115, 2-116, 2-123, 2-147, 2-155, 2-157, 2-158, 2-161, 2-163, 2-189, 2-278

V

Vapor pressure 2-6, 2-14 – 2-17, 2-28, 2-30, 2-44, 2-46, 2-52, 2-272, 2-273, 2-275, 2-276

Vapor pressure deficit 2-15, 2-16, 2-37, 2-57, 2-165, 2-168

Volumetric water content 2-82, 2-84, 2-155, 2-162, 2-275

W

Water conservation 2-225, 2-226

Water table 2-3, 2-8, 2-9, 2-115, 2-123, 2-125, 2-128, 2-130, 2-144, 2-155, 2-157, 2-158, 2-159, 2-160, 2-161, 2-166, 2-180, 2-182, 2-187, 2-276

Weather station 2-13, 2-15, 2-18, 2-19, 2-20, 2-37, 2-43, 2-46, 2-47, 2-48, 2-277

Weibull distribution 2-198, 2-200, 2-273

Wet soil evaporation 2-68, 2-85 – 2-89, 2-275, 2-277, 2-278

Wind run 2-13, 2-20, 2-21, 2-44, 2-46, 2-47, 2-53, 2-63, 2-70, 2-73, 2-279

Y

Yield decline 2-110, 2-273

Z

Zero plane displacement 2-18, 2-276

